

EuroDidact®

PHYSICS

Visit us at 3bscientific.com



Student Experiments
Mechanics
Waves

Energy and Environment
Thermodynamics
Optics

Electricity and Magnetism
Atomic and Nuclear Physics
Laboratory Equipment



Dr. Johannes Recht, *Business Field Manager Natural Sciences*

Dear Customer,

Are you fascinated by physics? Are you looking for opportunities to make your classes more exciting and more interesting? Would you like to be able to rely on your equipment sets and apparatus? Then have a look at this catalogue and take inspiration from the many new items inside. First let us point out some of the highlights of our constantly growing assortment of physics equipment:

Our high-quality **student experiment kits** have now been expanded to cover the following topics:

- Solar energy
- Electricity
- Ultrasonic waves
- Mechanical oscillations and waves

All student experiments kits naturally include detailed experiment instructions for both teachers and students.

The subject of **mechanics** is represented by an inexpensive version of Kater's reversible pendulum along with two new experiments for the investigation of elastic deformation and for the determining the modulus of elasticity, i.e. the shear modulus.

The section covering the subjects of **sound and ultrasound** has also been supplemented with some exceptional innovations:

- All new Kundt's tube with custom-made peripheral equipment
- Quincke's tube for investigating resonance
- The "Sound propagation in rods" and "Stereophonic hearing" equipment sets
- Equipment for experiments on ultrasonic computer tomography

Additional **highlights** include a compact solution for carrying out the Millikan experiment, the newly added Pockel's cell as well as apparatus for investigating the Hall effect in metals. In addition to this, we have upgraded the well-established ESCOLA analogue multimeter to make it even safer than before.

We hope you enjoy browsing through our catalogue and look forward to your feedback and orders. Naturally, our team of experts is always at your disposal should you need personal consultation.

With kind regards,

Dr. Johannes Recht
Business Field Manager Natural Sciences

► **New:** 3B Scientific® Physics Experiments Catalogue for Schools and Colleges with over 100 demonstration and practical experiments.

All you have to do is contact us and we will be happy to send you a copy of our experiment catalogue. You can find the catalogue to view as a PDF, for downloading or for ordering under "Request catalogue" in the "Customer Service" area of our web site.



Committed to quality

3B Scientific provides you with good quality at fair prices. Our sophisticated quality management complies with the ISO 9001 standards and the Worlddidac Quality Charter and is regularly approved by independent experts.

That's something you can rely on.



CONTENTS

4 NEW PRODUCTS	99 Mechanical waves	210 Charger and Discharger
8 STUDENT EXPERIMENTS	103 Sound	211 Electro-chemistry
8 3B STUDENT <i>Kit</i>	111 Ultrasound	214 Magnetism
15 Acoustics kit	120 ENERGY AND THE ENVIRONMENT	216 Magnetic fields
16 Student experiment kits (SEK)	120 Fuel cells / Solar energy	222 Conductors in magnetic fields
32 Kröncke optical system for student exercises	121 Greenhouse effect	224 Induction
34 Basic student experiments	122 Weather	228 Demountable transformer
35 Light box	123 Noise	231 Tesla coil transformer
36 Regenerative energy	124 HEAT AND THERMODYNAMICS	231 Free electrons in gases and in vacuum
37 Gas detector GASTEC	124 Thermometer	246 ATOMIC AND NUCLEAR PHYSICS
38 COMPUTER AIDED EXPERIMENTATION	128 Equivalent of heat	246 Periodic table of the elements
38 3B NET <i>lab</i> [™]	129 Calorimeters	247 Scanning tunneling microscope
39 3B NET <i>log</i> [™]	130 Thermal expansion	248 Model crystals
40 Sensors	133 Heat flow	249 Molecule building sets
47 Fourier analysis	134 Radiation of heat	250 Atomic orbitals
48 MECHANICS	136 Heat conduction	251 Millikan's experiment
48 Mechanics on a whiteboard	137 Gas laws	252 Fundamentals of atomic physics
49 Measurement of time	141 Cyclic processes	254 Franck-Hertz experiment
50 Measurement of length	146 LIGHT AND OPTICS	258 Fluorescence of sodium
51 Volume measurement	146 Optics on a whiteboard	258a-h X-ray apparatus
52 Dynamometers	149 Geometric optics	259 Radioactivity
53 Helical Springs	150 Kröncke optics	262 ESR/NMR
54 Balance weights	152 NEVA optical system	264 Hall effect in semiconductors
56 Gravitation / Astronomy	153 Optics using an optical bench U	265 Hall effect in metals
57 Statics	154 Optics using an optical bench D	266 INSTRUMENTATION
58 Friction	156 Optical lamps on stem	266 Power supplies
59 Simple machines	157 Optical components on stem	272 Function generators
61 Linear motion	160 Newton's rings / Fresnel mirror	275 Analogue oscilloscopes
64 Motion in a plane	161 Geometrical diaphragms	276 Digital oscilloscopes
67 Free fall / Uniform acceleration	162 Diffraction elements	278 Hand-held analogue measuring instruments
68 Vertical and horizontal trajectories	165 Filters	280 Hand-held digital measuring instruments
71 Physics on a small budget	166 Prisms / Optical crystals	284 Digital counters
72 Rotational motion	168 Faraday Effect	285 Rotational motion
74 Gyroscope	169 Wave optics using a laser	286 Magnetic fields
75 Oscillations	170 Colour	287 Microvoltmeter / Amplifier
83 Buoyancy	172 CCD HD Sensor	288 Laboratory scales
84 Density and volume	173 Pockels effect	290 Magnetic stirrers
86 Pressure	174 Polarisation	291 Heat sources
87 Surface tension	176 Spectrum tubes and spectrum lamps	292 Video cameras
88 Viscosity	178 Spectrometers	294 Microscopes
89 Elastic deformation	182 Mach-Zehnder interferometer	295 Various
90 Vacuum	183 Michelson interferometer	296 LAB MATERIAL
92 Vacuum pumps with hose connections	184 Solid-state laser physics	296 Stands, clamps and accessories
93 Vacuum pumps with flange connections	188 Equipment sets	298 Tubing
94 Aerodynamics	190 Speed of light	299 Experiment leads and cables
95 Laminar flow	191 Eye and vision	301 Various
96 WAVES AND SOUND	192 ELECTRICITY AND MAGNETISM	302 Glassware
96 Wave optics	192 Electrostatics	303 HISTORICAL EXPERIMENTS
98 Water waves	198 Electrical circuits	304 ALPHABETICAL INDEX
	206 3B Plug-in component system	314 NUMERICAL INDEX
		318 MORE PRODUCT RANGES

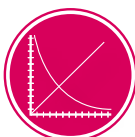

LEGEND

This tip names some experiments from our physics & engineering experiments catalogue which are suitable for the product. You can find these experiments on our web site 3bscientific.com by searching for the number listed.

UE2020200

NEW PRODUCTS

Apparatus for Measuring Young's Modulus

P-1018527

page 89

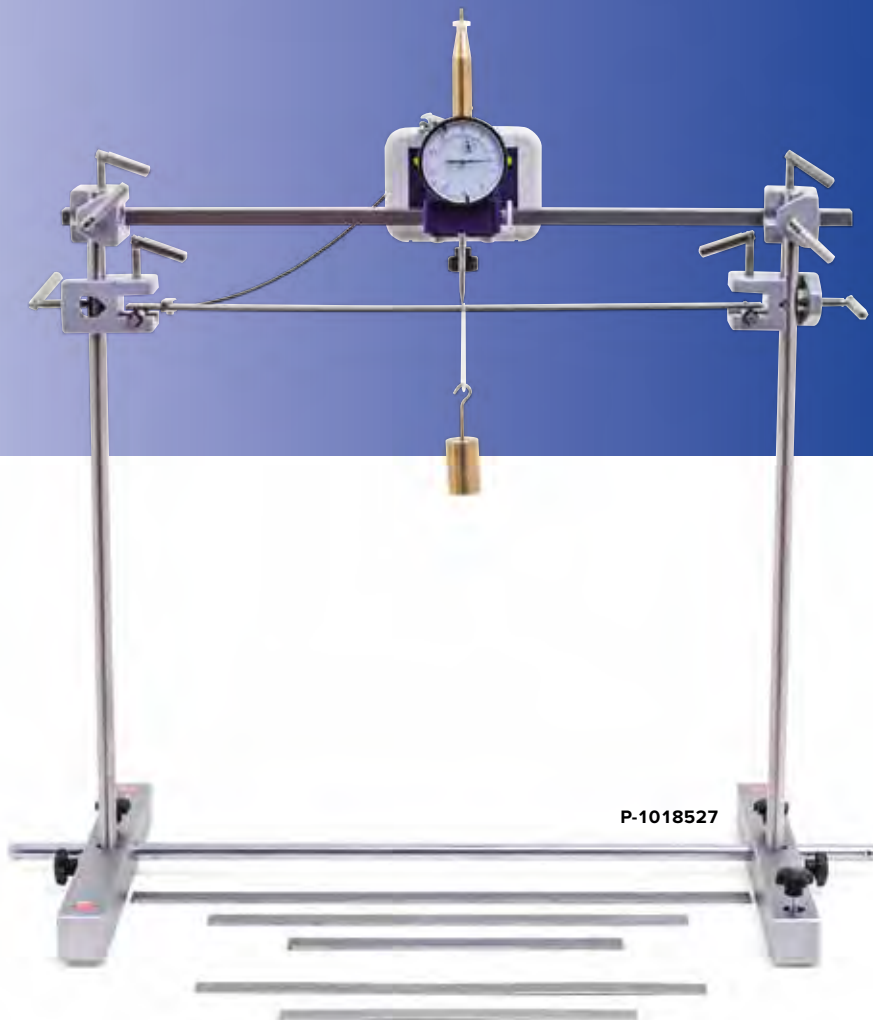

P-1018527

Torsion Apparatus

P-1018550

page 89



P-1018550

Quincke's Resonance Tube

P-1018475

page 103



P-1018475



P-1018466

page 77

Kater's Reversible Pendulum
P-1018466



P-1013393

page 173

Pockels Cell on Stem
P-1013393

Millikan's Apparatus (230 V, 50/60 Hz)
P-1019214

Millikan's Apparatus (115 V, 50/60 Hz)
P-1019213



P-1019214

Our low-cost compact solution

page 251

**“Sound Propagation in Rods” Equipment Set
(230 V, 50/60 Hz)**

P-1018469

**Equipment Set “Sound Propagation in Rods”
(115 V, 50/60 Hz)**

P-1018468



page **107**



P-1018469

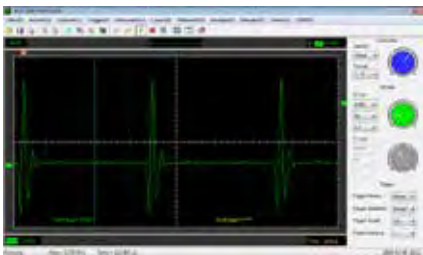

Propagation of longitudinal waves:
wave packets in a long rod

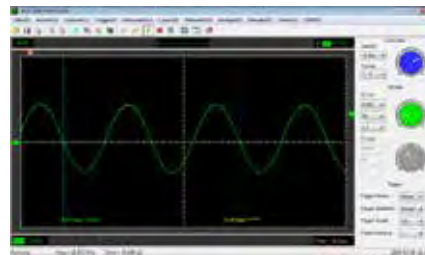

Propagation of longitudinal waves:
Sinusoidal vibration in a short rod

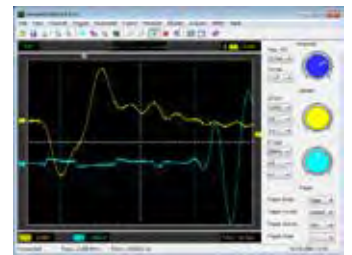

Propagation of shear waves in rods

Hall Effect in Metals

Copper Sample for Hall Effect
P-1018751

Zinc Sample for Hall Effect
P-1018752

Holder for Hall Effect
P-1018753

page **265**



New Products

“Stereophonic Hearing” Equipment Set
P-1018551.....

page 107



P-1018551

Cat Scan

CT Scanner
P-1017782.....

page 119



P-1017782



P-1017785

CT Measuring Trough
P-1017785.....



P-1017783

CT Controller
P-1017783.....



P-1017784

CT-Sample
P-1017784.....

New Products

3B STUDENT Kit Student Experiments for Lower Secondary Level

The versatile 3B STUDENT Kits allow students in lower secondary level to work independently in setting up and carrying out a comprehensive range of basic experiments on the topics of mechanics, heat, optics, electrostatics and electricity. Detailed instructions for the experiments, divided into pages for students and pages for teachers, help the students to perform the experiments and enable the teachers to make the necessary preparations.

Each equipment set-up enables students to work in pairs and requires a bench area of only 400 mm x 250 mm, which is sufficient to ensure a clear and stable set-up. The robust components are made of anodised aluminium, plastic or glass.

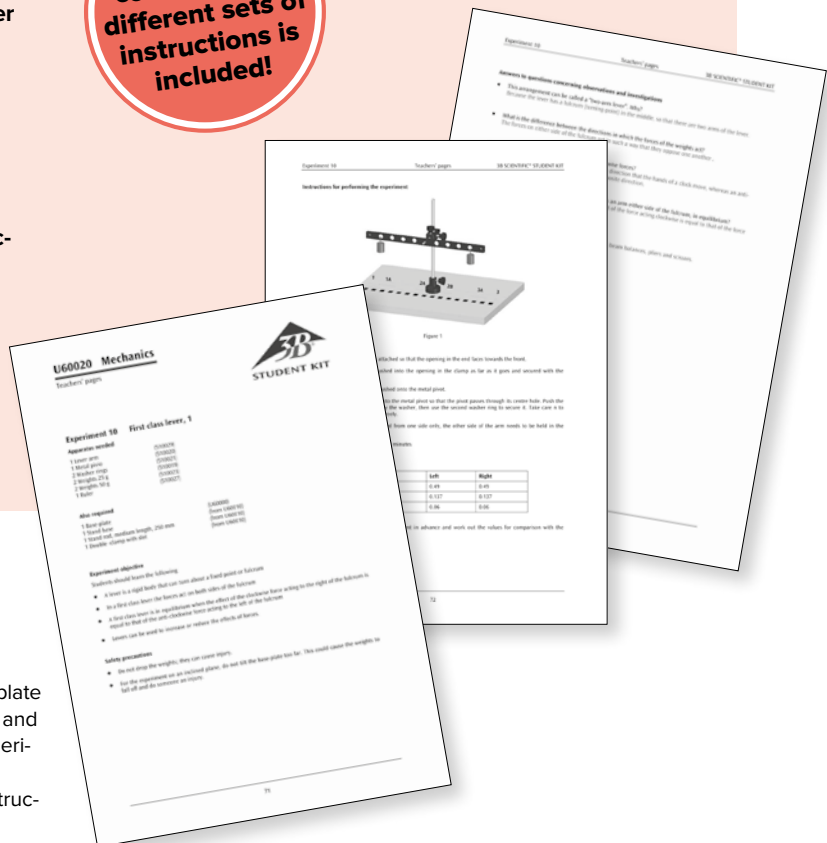
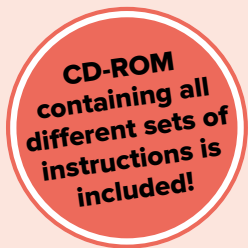

STUDENT Kit – Basic Set

Basic set of apparatus for use with STUDENT Kits for mechanics (P-1000731) and heat (P-1000732). Consisting of a robust base-plate made of plastic, stands and clamps made of anodised aluminium and other components that are used in both mechanics and heat experiments. In a robust plastic box with foam inserts moulded to the shapes of the items plus a transparent lid. Includes a CD with instructions for the experiments.

Contents:

- 1 Base-plate
- 2 Stand bases
- 2 Stand rods, 360 mm
- 1 Stand rod, 250 mm
- 2 Stand rods, 100 mm
- 2 Double clamps with slot
- 1 Clip, 8 mm diam.
- 1 Clip 22 mm diam.
- 1 Clip 27 mm diam.
- 1 Beaker, 500 ml
- 1 Test tube
- 1 Glass tube, 50 mm
- 1 Glass tube, 250 mm
- 1 Silicone tube, 500 mm x 6 mm diam.
- 4 g Glycerine
- 1 CD with sets of instructions for experiments

P-1000730.....

Please ask for quantity discounts on class sets for 8 pieces and more



STUDENT Kit – Mechanics

Set of apparatus for carrying out 25 basic student experiments on the mechanics of solids, liquids, and gases. In a robust plastic box with foam inserts moulded to the shapes of the items and a transparent lid. The experiments are designed to occupy as little space as possible on the base-plate of the STUDENT Kit basic set (P-1000730), while remaining clear and easy to perform. Includes a CD with instructions for the experiments.

P-1000731

Additionally required:

P-1000730 STUDENT Kit – Basic Set

Contents:

1 Steel leaf spring	1 Aluminium block
1 Lever arm	1 Wooden block
1 Ruler	1 Silicone tube, 500 mm x 3 mm diam.
1 Pulley	1 Tubing connector
1 Pulley with hook	1 Clip, 8 mm diam.
1 Weight, 100 g	1 Clip, 14 mm diam.
3 Weights, 50 g	1 Syringe, 60 ml
2 Weights, 25 g	1 Syringe, 30 ml
1 Dynamometer, 2 N	1 Plastic sphere
1 Metal pivot	1 Rubber stopper (30 mm x 31/25 mm diam.)
4 Washer rings to fit metal pivot	1 Funnel, 40 mm diam.
1 Pulley with cord	1 U-tube manometer
1 Trolley	1 Measuring cylinder
1 Friction pad	100 g Modelling clay
1 Coil spring	
1 Iron block	



P-1000731

Includes 25 Experiments on the Subject of Mechanics:

- Effects of forces
- Action and reaction
- Deformation by forces (2 experiments)
- Masses and densities of bodies
- Friction
- Second class lever
- First class lever (2 experiments)
- Fixed pulley
- Moving pulleys
- Combinations of fixed and moving pulleys (block and tackle)
- Inclined plane (2 experiments)
- Connected vessels
- Pressure in liquids
- Principle of the U-tube manometer
- Pressure due to weight of fluids
- Buoyancy in liquids
- Floating and sinking
- Air as a body
- Pressure and volume
- Temperature and volume
- Effects of atmospheric pressure

Equipment Mechanics:

P-1000731 STUDENT Kit – Mechanics

P-1000730 STUDENT Kit – Basic Set



First class lever

STUDENT Kit – Heat

Set of apparatus for carrying out 10 basic student experiments on heat. In a robust plastic box with foam inserts moulded to the shapes of the items and a transparent lid. The experiments are designed to occupy as little space as possible on the base-plate of the STUDENT Kit basic set (P-1000730), while remaining clear and easy to perform. Includes a CD with instructions for the experiments.

Contents:

- 1 Conical flask, 100 ml
- 1 Bimetallic strip
- 1 Concave mirror mounted on stem
- 1 Aluminium rod 200 mm
- 1 Thermometer, -10°C – $+100^{\circ}\text{C}$
- 1 Glass tube with 90° bend
- 1 Rubber stopper, 25 mm x 24/19 mm diam.
- 1 Spirit burner
- 1 Ceramic mat

P-1000732

Additionally required:

P-1000730 STUDENT Kit – Basic Set

**CD-ROM
containing all
different sets of
instructions is
included!**



P-1000732

Includes 10 Experiments on the Subject of Heat:

- Principle of a thermometer
- Heating of solid bodies
- Heating of liquid bodies
- Heating of gases
- Behaviour of bimetallic objects
- Conduction of heat
- Radiation of heat
- Condensation
- Distillation
- Temperature of mixtures

Equipment Heat:

P-1000732 STUDENT Kit – Heat

P-1000730 STUDENT Kit – Basic Set

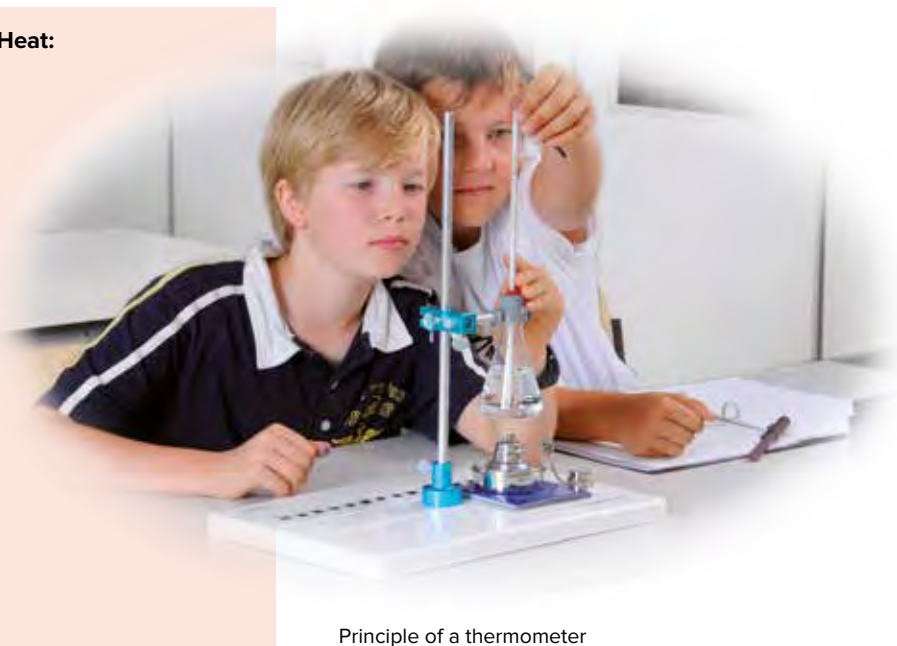

Principle of a thermometer

STUDENT Kit – Optics

Set of apparatus for carrying out 23 basic student experiments in optics. In a robust plastic box with foam inserts moulded to the shapes of the items and a transparent lid. Includes a CD with instructions for the experiments. The experiments are designed to occupy as little space as possible on the included optical bench, while remaining clear and easy to perform.

Contents:

- 2 Lenses, $f = +100$ mm
- 1 Lens, $f = +50$ mm
- 1 Lens, $f = -100$ mm
- 1 Lens, $f = +300$ mm
- 1 Diaphragm holder
- 1 Plug-in power supply unit for optical lights
- 1 Optical light
- 1 Overlay mask protractor
- 1 Projection screen/experiment table
- 1 Optic bench
- 2 Tea lights
- 1 Opaque body
- 1 Single aperture slot
- 1 Triple aperture slot
- 1 Colour slide M-Y-C
- 1 F diaphragm
- 1 Flexible mirror
- 1 Coplanar board
- 1 Semicircular body
- 1 Converging lens
- 1 Diverging lens
- 1 Right-angled prism
- 2 Sheets of graph paper, transparent DIN A5
- 1 Scale



P-1000734
P-1000733

STUDENT Kit Optics (230 V, 50/60 Hz)

P-1000734

STUDENT Kit Optics (115 V, 50/60 Hz)

P-1000733

Includes 23 Experiments on the Subject of Optics:

- Propagation of light
- Light and shadows
- Reflection at a plane mirror
- Concave and convex mirrors
- Refraction of light (2 experiments)
- Refractive index
- Optical lenses (paths of rays)
- Focal point of convergent lenses
- Focal length of convergent lenses
- Formation of images with converging lenses
- Laws of images
- Magnifying glasses
- Function of the eye
- Function of spectacles (2 experiments)
- Principle of a camera
- Principle of a slide projector
- Principle of a Galilean telescope
- Principle of an astronomical telescope
- Principle of a microscope
- Breaking down light into its components
- Mixing of colours

Equipment Optics:

P-1000734 STUDENT Kit – Optics (230 V, 50/60 Hz)

or

P-1000733 STUDENT Kit – Optics (115 V, 50/60 Hz)



Principle of a slide projector

new

STUDENT Kit – Electricity

Set of apparatus for carrying out 28 fundamental student experiments on electricity. Stored in a tough Gratnells tray with foam inlay featuring recesses moulded to the shape of the apparatus and covered by a transparent lid. Circuits are assembled using components in plug-in housings plugged into a plug-in board. Power is supplied via 2 D-cell, LR20, 1.5 V batteries (batteries not included) or via an external power supply. Includes a CD with instructions for the experiments.

P-1017213

Contents:

- 1 Plug-in Board for Components
- 2 Battery Holders
- 1 Set of Conductors and Non-Conductors
- 1 Set of 10 E10 lamps; 1.3 V, 60 mA
- 1 Set of 10 E10 lamps; 3.8 V, 300 mA
- 3 E10 lamp sockets
- 2 Change-over switches
- 1 Toggle switch, single pole
- 1 Push-button (NO), single pole
- 1 Roll of chrome-nickel wire
- 1 Roll of constantan wire
- 1 Roll of iron wire
- 1 Set of 10 connecting plugs
- 6 Connecting plugs, 4 mm
- 6 Crocodile clips
- 1 Potentiometer, 220 Ω
- 1 Linear Resistor, 47 Ω, 2 W
- 2 Linear Resistors, 100 Ω, 2 W
- 2 Zinc plates
- 2 Copper plates
- 2 Carbon plates
- 1 Glass trough
- 1 Set of 3 experiment leads, red
- 1 Set of 3 experiment leads, blue
- 1 Roll of experiment cord
- 1 Weight, 50 g
- 1 Tea candle

STUDENT Kit – Electricity



P-1017213

Includes Instructions for 28 Experiments on Electricity:

- Simple electric circuits (2x)
- Electrical conductors and insulators
- Production of heat and light
- Various sources of electricity *
- Conduction in liquids *
- Single-pole change-over switches (SPDT)
- Two-way switches
- Measurement of current in a simple electric circuit **
- Measurement of voltage in a simple electric circuit **
- Incandescent lamps connected in series
- Incandescent lamps connected in parallel
- Terminal voltage and open-circuit (no-load) voltage **
- Batteries connected in series and parallel **
- Battery made from a lemon **
- Relationship between voltage and current determined by varying voltage * / **
- How electrical power depends on other variables in an electric circuit * / **
- How electrical work depends on other variables in an electric circuit * / **
- Ohmic resistance * / **
- How electrical resistance depends on temperature (2x) * / **
- How electrical resistance depends on the length of the wire * / **
- How electrical resistance depends on the cross section of the wire * / **
- How electrical resistance depends on the material of the wire * / **
- Resistivity * / **
- Resistors connected in series * / **

- Resistors connected in parallel * / **
- Variable resistors
- Potentiometers * / **

Equipment Electricity:

P-1017213 STUDENT Kit – Electricity

P-1002776 DC power supply, 0 – 12 V, 3 A (230 V; 50/60 Hz)

or

P-1002775 DC power supply, 0 – 12 V, 3 A (115 V; 50/60 Hz)

(for experiments marked *)

P-1013526 Analogue Multimeter ESCOLA 30

(for experiments marked **)

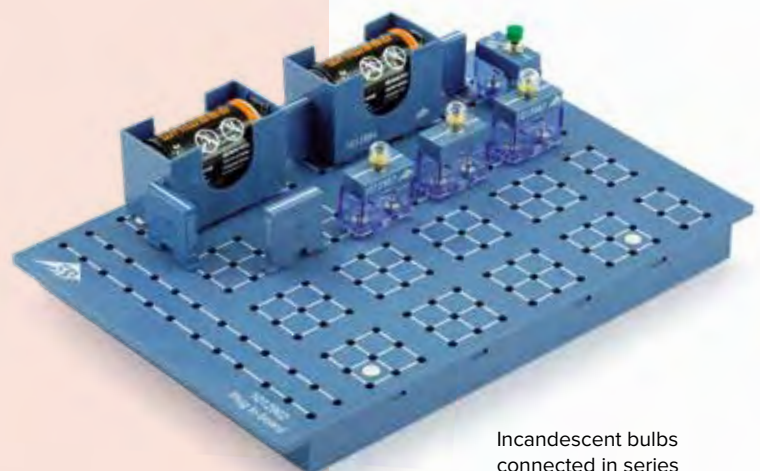

Incandescent bulbs connected in series

Student Experiments



Battery made from a lemon

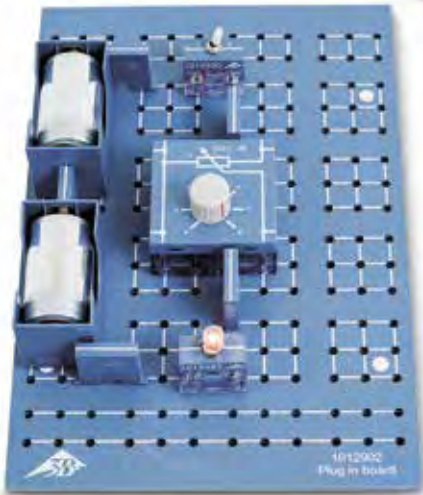

Variable resistors

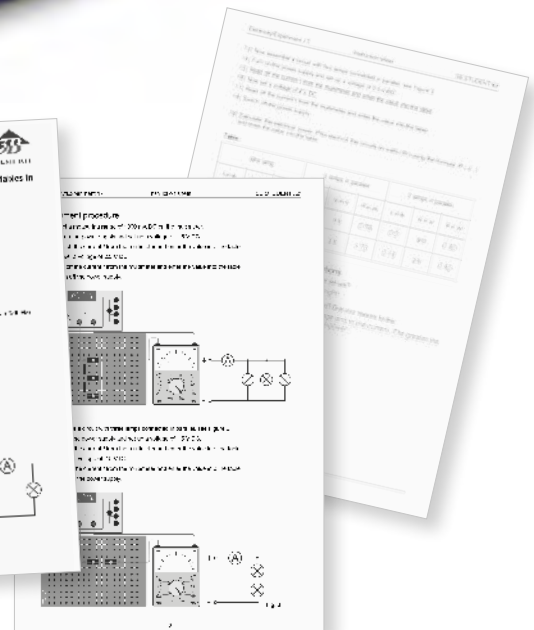
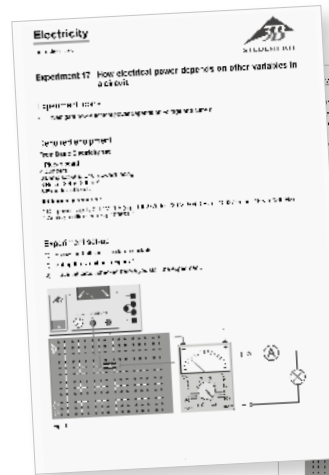

Please ask for quantity discounts on class sets for 8 pieces and more

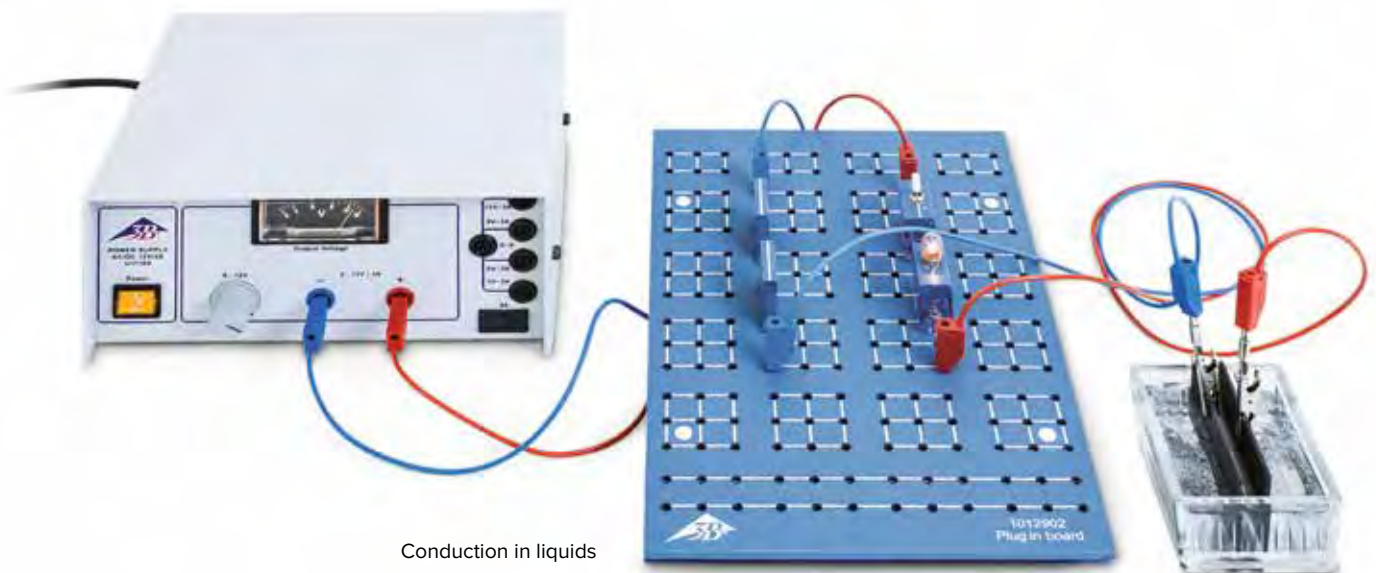

Conduction in liquids

Acoustics Kit

Complete set of equipment for carrying out more than 30 student experiments on acoustics. In plastic tray with foam inlay.
 Dimensions: 530x375x155 mm³ approx.
 Weight: 4.5 kg approx.

Contents:

- 1 Monochord, with ruler and musical scale
- 1 Steel string
- 1 Perlon string
- 1 Spring balance on support
- 1 Reed pipe with 8 valves
- 1 Tuning fork with plotter pen, 21 Hz
- 1 Tuning fork, 440 Hz
- 1 Light-metal tuning fork, 1700 Hz
- 1 Pipe
- 1 Variable-length closed air column
- 1 Tuned open air column
- 1 Chladni disc with rod
- 1 Bell dome
- 1 Galton whistle
- 1 Kundt pipe with retaining clip
- 5 g Lycopodium powder in sprinkling cellar
- 1 Metallophone with beater
- 1 Rope for demonstrating waves
- 1 Helmholtz resonator, 70 mm diam.
- 1 Helmholtz resonator, 52 mm diam.
- 1 Helmholtz resonator, 40 mm diam.
- 1 Helmholtz resonator, 32 mm diam.
- 1 Screw clamp
- 1 Plastic block
- 1 Plunger



P-1000816

P-1000816

Representation of oscillations with a tuning fork with plotter pen

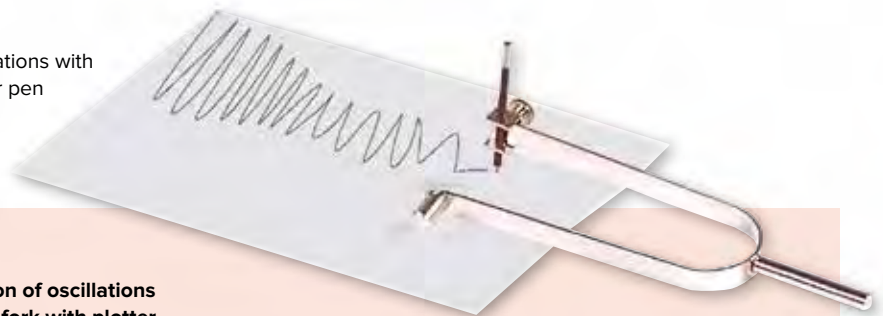

Experiment Topics:

- Noise, bangs, pure tones
- Vibrating air columns
- Whistles and pipes
- Vibrating bars, plates and bells
- Infra-sound
- Ultra-sound
- Tuning fork with plotter pen
- Travelling waves along a rope
- Velocity of propagation of sound
- Moving sources of sound (Doppler effect)
- Plate vibrations (Chladni figures)
- Vibrations of a bell
- Standing waves on a rope, overtones
- Sounds of musical instruments
- Representation of oscillations with a tuning fork with plotter pen
- Timbre of the human voice
- Measurement of wavelength (Kundt figures)
- Resonance
- Helmholtz ball resonators
- Sound analysis
- Loudness
- Pitch of string instruments
- Pitch of wind instruments
- Reed pipe
- C-major scale and its intervals
- Triads, harmonies
- Semitones, major and minor

The acoustics kit allows students to carry out numerous experiments on acoustics independently. A wide variety of sound sources are studied to begin with and the concepts of noise, bangs and tones as well as pitch and loudness are investigated. Waves along a rope are used to illustrate harmonic vibrations and overtones. There is also some extensive study of various different musical instruments. Different high-pitched tones are generated by means of a monochord and the ensuing intervals are calculated experimentally. These studies are expanded to other instruments and can easily lead over to a study of musical notes.

Student Experiment Kits (SEK)

With the comprehensive and practical student experiment kits students can independently carry out numerous experiments on mechanics, heat, optics, electricity and magnetism, solar energy, oscillations and waves, or radioactivity. To help them there are detailed instructions for all the experiments. Each of the experiments only requires a small amount of space, but nevertheless an easily understood and stable set-up is always assured. The prescribed layouts for the experiment set-ups make it possible for teachers to quickly assess the progress and success achieved by individual students conducting the experiments.

SEK Mechanics

Set of equipment for carrying out 23 student experiments on the mechanics of solids. In a tough plastic box containing a foam insert with cut-outs for the equipment and featuring a transparent lid. Includes CD with experiment instructions. Experiments are set up and performed on the SEK base plate (P-1000789) so that they are compact but still clear in their layout and objectives.

P-1008527



P-1008527

Contents:

- 2 Stand rods with external and internal thread, 400 mm
- 1 Stand rod with external thread, 400 mm
- 2 Stand rods, 110 mm
- 2 Double clamps
- 1 Beam balance
- 2 Weighing pans with holders
- 1 Scale for balance
- 1 Axle rod for pulleys
- 1 Rolling pin with add-on weights
- 1 Block and tackle with two pulleys and two hooks
- 1 Block and tackle with two pulleys and one hook
- 1 Multiple pulley
- 1 Plastic pulley, 40 mm
- 4 Weights, 25 g
- 1 Weight, 50 g
- 1 Weight, 100 g
- 1 Magnetic base
- 1 Adjustable bracket
- 2 S-shaped hooks, 1 g
- 2 S-shaped hooks, 2 g
- 2 S-shaped hooks, 5 g
- 4 O-rings
- 1 Body for friction and inertia experiments
- 1 Set of plastic strips for friction experiment
- 1 Dynamometer 1 N
- 1 Dynamometer 2 N
- 1 Leaf spring, 330 mm
- 1 Coil spring with 2 eyelets, approx. 5 N/m
- 100 m of twine
- 2 Pointers
- 1 Measuring cylinder
- 1 Stand base for measuring cylinder
- 3 Strips of velour paper
- 1 Set square
- 1 Ruler

Please ask for quantity discounts on class sets for 8 pieces and more

Includes 23 Experiments on the Subject of Mechanics:

- Hooke's law
- Calibrating a dynamometer
- Deformation of a leaf spring
- Addition of forces acting along the same line
- Resolution of a force into two components
- Investigation of inertia
- Types of friction
- Laws of static and kinetic friction
- Equilibrium conditions for a first-class lever
- Equilibrium conditions for second and third-class levers
- Forces, paths and work with fixed pulleys
- Forces, paths and work with non-fixed pulleys
- Forces, paths and work with block and tackle
- Forces, paths and work with multiple pulleys
- Forces on an inclined plane
- Determining the volume of solid bodies
- Determining the mass of solid bodies (beam balance)
- Determination of density
- Determining the nature of a material by measuring density
- Specific weight and buoyancy
- Period of a string pendulum
- Determining gravitational acceleration with the aid of a string pendulum
- Period of a spring oscillator

Equipment mechanics:

P-1008527 SEK Mechanics

P-1000789 SEK Base Plate

SEK Base Plate

Tilt-resistant stainless-steel base with five special threads for the tilt-free insertion of stand rods, threads for mounting a dismantling transformer and numerous expansion slots for the insertion of electrical components. With stable and nonslip rubber feet. Dimensions: 400x245x15 mm³ approx.

P-1000789

CD-ROM containing all different sets of instructions is included!



P-1000789

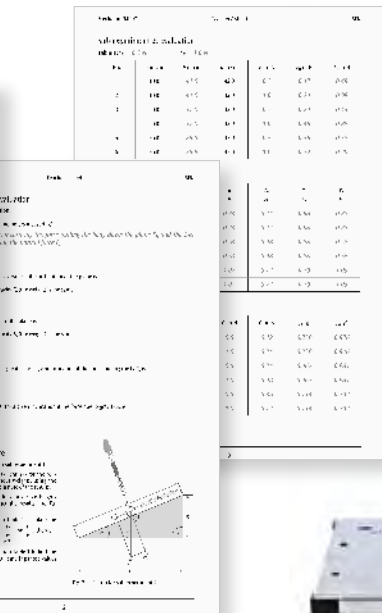
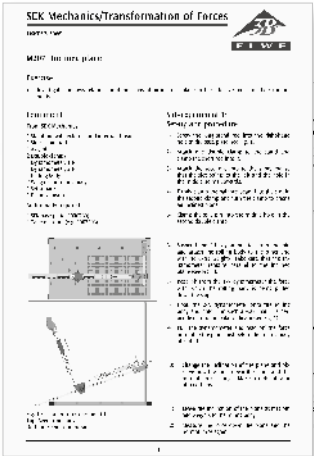

Block and tackle



Hooke's law



Second and third-class levers

SEK Heat

Set of equipment for carrying out 22 basic student experiments on heat. In a tough plastic box containing a foam insert with cut-outs for the equipment and featuring a transparent lid. Includes CD with experiment instructions. Experiments are set up and performed on the SEK base plate (P-1000789) so that they are compact but still clear in their layout and objectives.

P-1008528

Contents:

- | | |
|--|--|
| 1 Stand rod with internal and external threads, 400 mm | 2 Thermometers, -10 – 110°C, 1 K, red liquid |
| 4 Wooden rods | 1 Capillary tube |
| 1 Metal tube, short | 1 Bimetal strip with 10-mm stub |
| 1 Pointer/hook | 10 Round filters |
| 1 Stirrer | 10 Sheets of thermal paper |
| 1 Steel tube | 1 Steel body |
| 1 Brass tube | 1 Lead body |
| 1 Aluminium tube | 1 Spirit burner |
| 1 Thermometer without scale, red liquid | 1 Beaker, 100 ml |
| | 1 Conical flask, 100 ml |
| | 1 Test tube holder with rod attachment |
| | 1 Test tube |
| | 1 Measuring cylinder, 50 ml |
| | 1 Calorimeter with heating filament, 200 ml |
| | 1 Rubber stopper with two holes |
| | 2 Rubber stoppers with one hole |
| | 1 10 g weight with hook |
| | 2 Double clamp |
| | 5 ml of food colouring |
| | 10 g of table salt |
| | 1 Holder for metal beaker |
| | 1 Metal beaker, black |
| | 1 Metal beaker, aluminium |
| | 4 g of glycerine |
| | 1 Hose |
| | 2 Round gaskets |
| | 1 Angle scale |
| | 10 Sheets of paper |
| | 5 Sheets of aluminium foil |



P-1008528

Includes 22 Experiments on the Subject of Heat:

- Change in the volume of liquids due to heating
- Calibration of a thermometer
- Change in the volume of air due to changes in temperature
- Changes in state of an enclosed volume of air
- Changes in the length of solid bodies when heated
- Linear expansion coefficient
- Investigations using bimetal strips
- Transfer of heat in solid bodies
- Transfer of heat in liquids
- Transfer of heat in gases
- Radiation of heat
- Slowing down the transport of heat
- Temperature changes when liquids are heated
- Fundamental equation of thermodynamics
- Mixing water of differing temperatures, temperature of mixture
- Specific heat capacity of a calorimeter
- Specific heat capacity of metals
- Initial temperature of a metal body heated in a flame
- Conversion of electrical energy into heat
- Temperature changes when ice melts
- Specific latent heat of melting ice
- Boiling and condensation of water
- Distillation
- Evaporation of liquids (what it depends on and heat loss due to evaporation)

Equipment Heat:

P-1008528 SEK Heat

P-1000789 SEK Base Plate

Please ask for quantity discounts on class sets for 8 pieces and more



Changes in the length of solid bodies when heated

CD-ROM containing all different sets of instructions is included!

SEK Thermodynamics/Heat transfer

K205: Investigation of the transfer of heat

Experiment 1: Heat transfer in solid bodies

Experiment 2: Specific heat capacity of metals

Substance	Initial Temp (°C)	Final Temp (°C)	Time (s)
Water	20	30	120
Aluminum	20	30	180
Copper	20	30	240

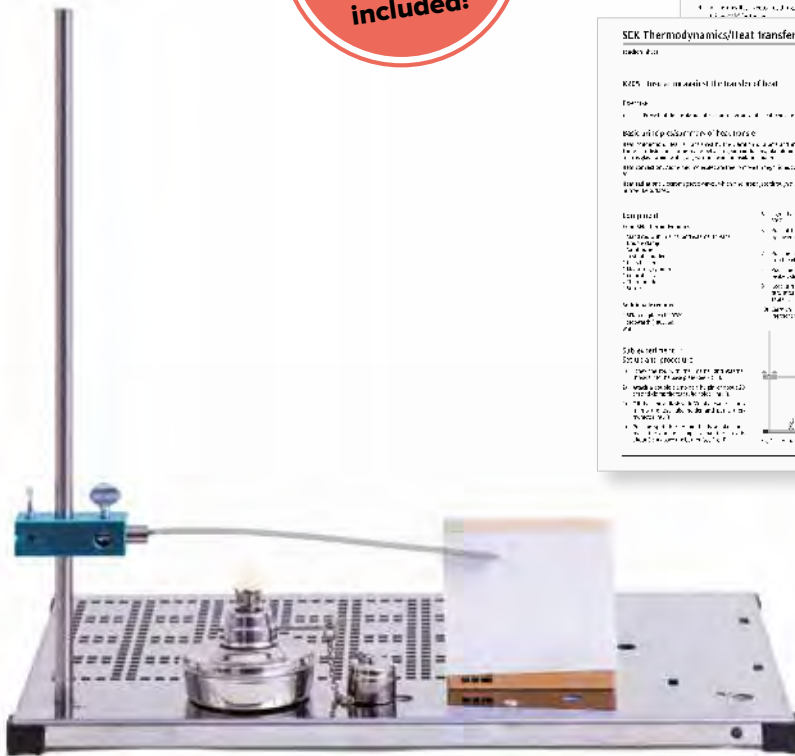

Investigation of a bi-metallic strip

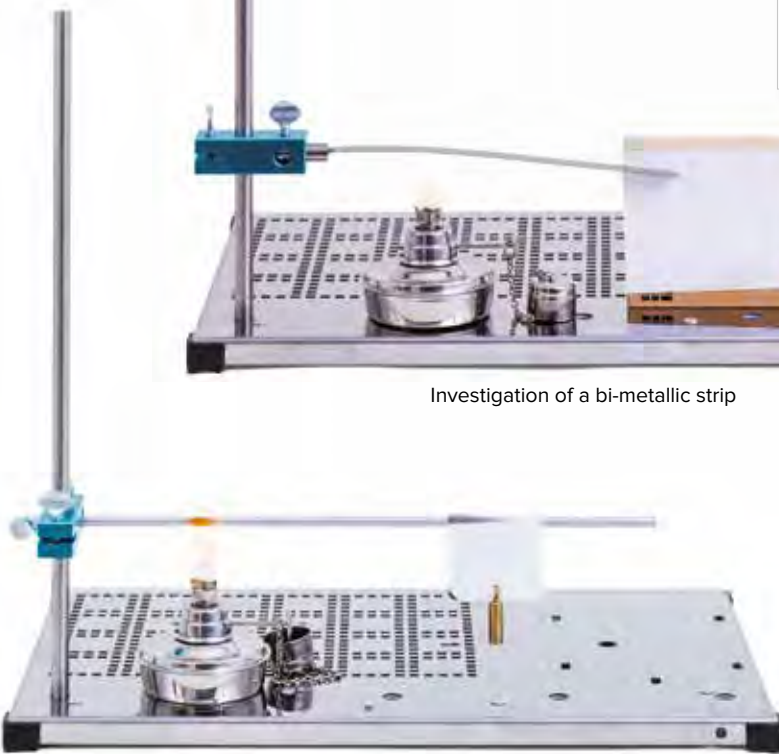

Heat transfer in solid bodies



Specific heat capacity of metals

Thermodynamics/K205 SFK

Teachers' sheet

Complete the following:

A Dewar vessel (Thermos flask) is designed to reduce all three kinds of heat transfer to a minimum (heat insulation).

- The mirrored surface of the double-walled glass vessel insulates against much of the *heat radiation*.
- The partial vacuum inside the double-walled vessel and the insulating layer between the vessel and its lid suppress most of the *heat convection and conduction*.
- The calorimeter is therefore *insulated* against losing heat to the surroundings.
- A Thermos flask keeps hot things *hot* and cold things *cold* for longer.

Give reasons for the following:

- Refrigerated trolleys (as used on trains) are painted white or silver.
Heat radiation is then reflected away instead of being absorbed.
- The handles of most saucepans are made of plastic.
The plastics used for such handles are poor conductors.
- Foam is good at insulating heat.
This is because the many bubbles of air prevent both conduction and convection of heat.

SEK Electricity and Magnetism

Set of equipment for carrying out 41 student experiments on electricity and magnetism. In a tough plastic box containing a foam insert with cut-outs for the equipment and featuring a transparent lid. Includes CD with experiment instructions. The experiments are set up and performed in a space saving fashion but are still clearly laid out on the SEK base plate (P-1000789).

P-1008532

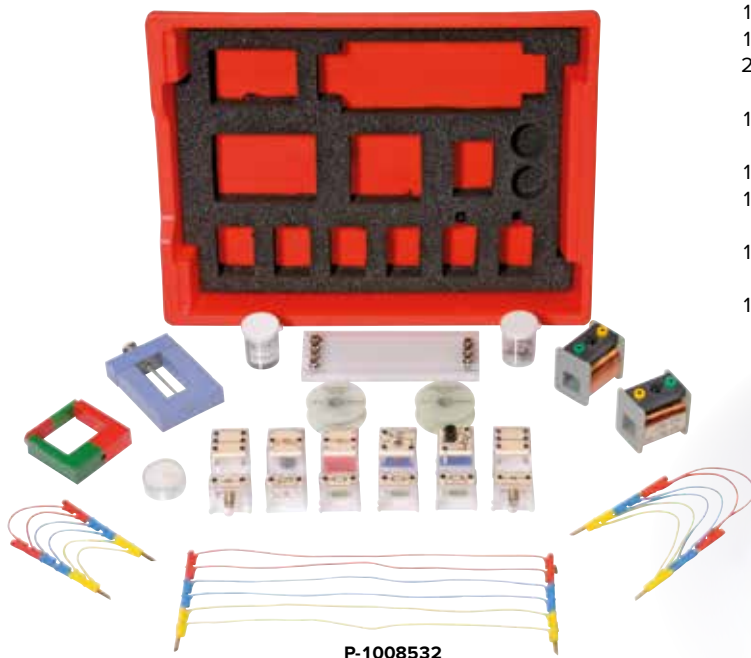

**Please ask for quantity discounts
on class sets for 8 pieces and more**

Contents:

- | | |
|--|--|
| 1 Set of experiment leads | 1 Resistor, 47 Ω
(plug-in component) |
| 1 Bar magnet,
65x16x5 mm approx. | 1 Resistor, 1 k Ω
(plug-in component) |
| 1 Horseshoe magnet, ALNICO,
flat | 1 NTC-resistor, 100 Ω
(plug-in component) |
| 1 Resistor board | 2 Lamp sockets, E10
(plug-in components) |
| 1 Transformer core, 20x20 mm | 2 Light bulbs, E10, 7 V |
| 1 Tightening screw | 1 Storage box with 1 set
of threads with washer,
2 threaded bushes, 2 thread-
ed pins, 2 Paper clips, 2 alu-
minium electrodes, constant
wire |
| 1 Coil, 200/400/600 windings | 50 g of iron filings |
| 1 Coil, 400/400/800 windings | 50 m of chrome/nickel wire,
0.2 mm |
| 2 Current branches
(plug-in components) | 50 m of iron wire, 0.2 mm |
| 1 Potentiometer, 100 Ω
(plug-in component) | 1 Tea candle |
| 1 Switch (plug-in component) | |
| 1 Capacitor, 4700 μ F
(plug-in component) | |
| 1 Capacitor, 10 μ F
(plug-in component) | |
| 1 Resistor, 33 Ω
(plug-in component) | |



Transformer under load

Includes 41 Experiments on the Subject of Electricity and Magnetism:

- Closed circuits
- Conductors and insulators
- Circuits with no branches
- Circuits with branches
- Current in a circuit with no branches
- Current in a circuit with branches
- Initial voltage and terminal voltages
- Voltage in a circuit with no branches
- Voltage in a circuit with branches
- Voltage dividers
- Ohm's law
- Temperature dependence of a resistor (iron wire)
- Current-voltage diagram for a light bulb
- Current-voltage diagram for a thermistor
- Law of resistance
- Resistance in a circuit with no branches
- Resistance in a circuit with branches
- Resistance and voltage in a circuit with no branches
- Resistance and current in a circuit with branches
- Voltage dividers with and without a load
- Voltage-time diagram for charging and discharging of a capacitor
- Current-time diagram for charging and discharging of a capacitor
- Relationship between charge and voltage
- Capacitor in the DC and AC circuit (response)
- Test bodies in a magnetic field
- Magnetic poles
- Magnetic field of a horseshoe magnet and a bar magnet
- Magnetic dipoles
- A coil used as a magnet
- Forces in the magnetic field of a coil
- Induction due to relative motion
- Induction due to changes in magnetic field
- Induction law
- Ohmic resistance in AC and DC circuits
- Capacitors in AC and DC circuits (resistance)
- Coils in AC and DC circuits
- How a transformer works
- Voltage and number of windings for a transformer with no load
- Transformer under load
- Transformer under heavy load
- Thermoelectricity

Equipment Electricity:

P-1008532 SEK Electricity and Magnetism

P-1000789 SEK Base Plate

P-1013526 Analogue Multimeter ESCOLA 30

P-1000998 SEK Power Supply (230 V, 50/60 Hz)

or

P-1000997 SEK Power Supply (115 V, 50/60 Hz)



P-1000998
P-1000997

SEK Power Supply

AC/DC power supply for SEK electricity and magnetism kit (P-1008532). Housing with attachment hooks for clamping into the SEK base plate (P-1000789).

Voltages: 1.5/ 3.0/ 4.5/ 6.0 V AC/DC

SEK Power Supply (230 V, 50/60 Hz)

P-1000998

SEK Power Supply (115 V, 50/60 Hz)

P-1000997

CD-ROM containing all different sets of instructions is included!

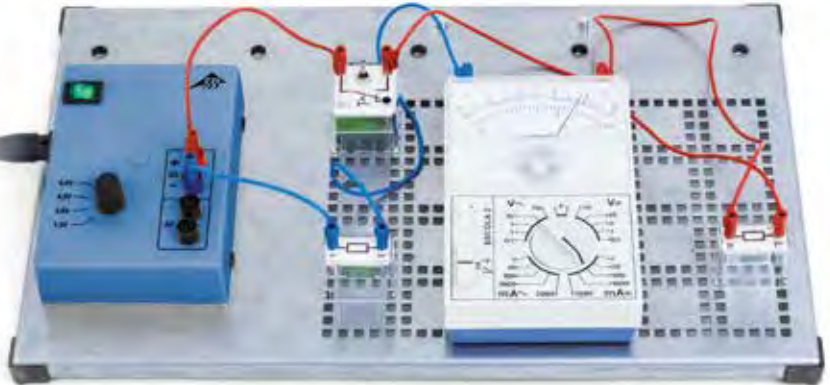

Electric current in circuits with no branches

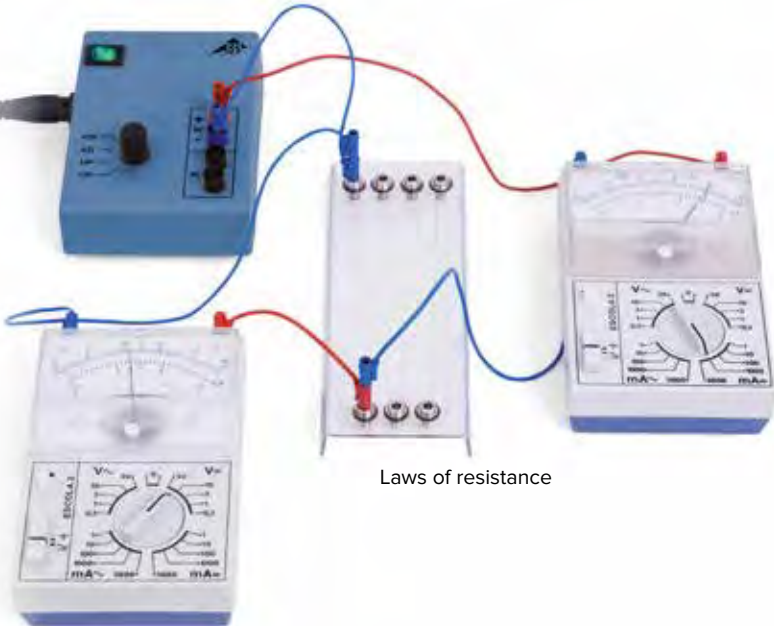

Laws of resistance

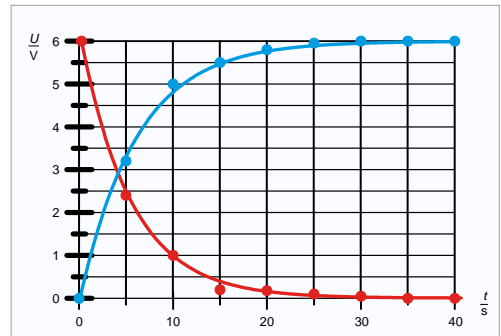

Capacitor: charging (blue) and discharging (red)

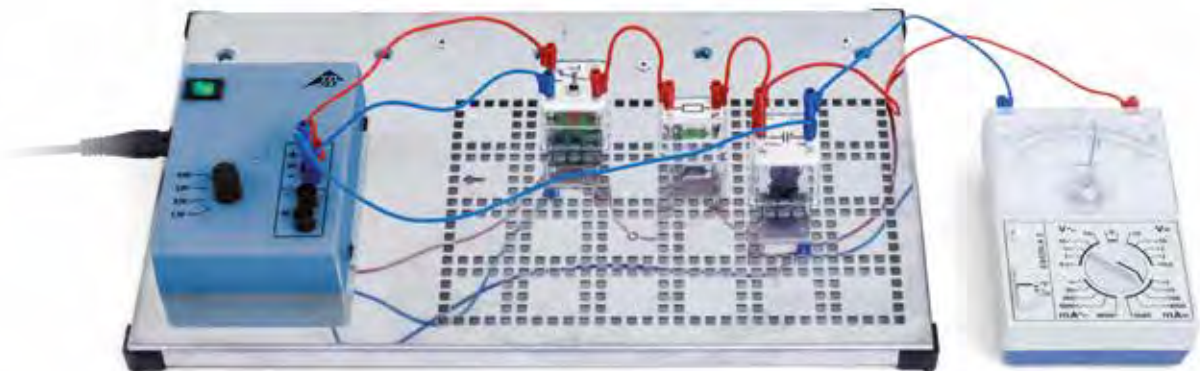

Charging and discharging of a capacitor (voltage)

SEK Optics

Set of equipment for carrying out 38 student experiments on ray optics. In a tough plastic box containing a foam insert with cut-outs for the equipment and featuring a transparent lid. Includes CD with experiment instructions. The experiments are designed to be compact but still easy to see when set up and carried out on the supplied optical bench or the SEK base plate (P-1000789). In both cases, the optical components are attached in non-slip fashion by magnets. Supplied overlays designate where the components are to be placed.

SEK Optics (230 V, 50/60 Hz)**P-1008531****SEK Optics (115 V, 50/60 Hz)****P-1008530****Contents:**

1 Optical bench	1 Semi-circular body
1 Optical lamp, 5 V, 2 W	1 Diverging lens, flat model
1 Plug-in power supply, 100 – 240 V, 50/60 Hz	1 Converging lens, flat model
4 Tea candles	1 Right-angled prism
1 Plastic container	1 Rectangular block
1 Slide holder, magnetic	1 Objects for casting shadows
1 F-shaped slide	1 Flexible mirror, magnetic
1 Slide with triple and quintuple slits	1 Projection screen/ Experimenttable
1 Slide with single slit	2 Lenses, $f = +50$ mm
1 Object for use as an image	1 Lens, $f = +100$ mm
1 Colour filter, red	1 Lens, $f = +300$ mm
1 Colour filter, blue	1 Lens, $f = -100$ mm
1 Acrylic block with holder	1 Set of overlays



P-1008531
P-1008530

CD-ROM
containing all
different sets of
instructions is
included!

Includes 38 Experiments on the Subject of Optics:

- Propagation of light, light beams and rays
- Transparency
- Light and shadow
- Umbra and penumbra
- Reflection from a plane mirror
- Concentration of light by a concave mirror
- Reflection and path of light for a concave mirror
- Reflection and path of light for a convex mirror
- Characteristics of the image from a plane mirror
- When light passes from air into glass / Determination of refractive index
- When light passes from glass into air / Determination of refractive index
- Determination of critical angle for total internal reflection (glass to air)
- Ray diagrams for a rectangular glass block, laws
- Ray diagrams for a glass prism
- Total internal reflection inside a prism
- Path of light through a converging lens
- Determination of focal length for a converging lens
- Ray diagrams with parallel ray and ray through centre of lens (converging lens)
- Path of light through a diverging lens
- Determination of focal length for a diverging lens
- Ray diagrams with parallel ray and ray through centre of lens (converging lens)
- Path of light through a system of lenses
- Image properties (converging lens)
- Image magnification and the lens equation
- Image aberrations with converging lenses
- Formation of images in the eye
- Short-sightedness
- Long-sightedness
- Astigmatism
- Cameras
- Slide projectors
- Microscopes
- Galileo telescope
- Kepler's telescope
- Terrestrial telescope
- Separation of light into a spectrum
- Recomposition of spectral colours
- Additive mixing of colours, complementary colours

Equipment Optics:

P-1008531 SEK Optics (230 V, 50/60 Hz)

or

P-1008530 SEK Optics (115 V, 50/60 Hz)



Reflection and path of light for a convex mirror

Please ask for quantity discounts on class sets for 8 pieces and more



Reflection in a plane mirror

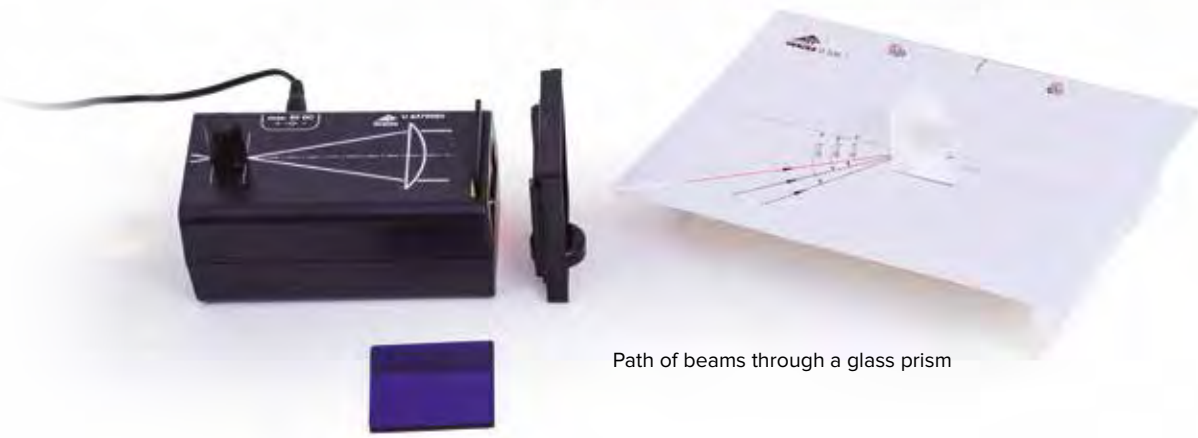

Path of beams through a glass prism



Model microscope

► new

SEK Mechanical Oscillations and Waves

Large equipment set for carrying out 23 fundamental experiments on the properties of mechanical oscillations and waves. Stored in a tough Graton tray with foam inlay featuring recesses moulded to the shape of the apparatus and covered by a transparent lid. Includes CD with experiment instructions.

SEK Mechanical Oscillations and Waves (230 V, 50/60 Hz)

P-1016652

SEK Mechanical Oscillations and Waves (115 V, 50/60 Hz)

P-1018476

Contents:

1 MEC control unit	2 Stand rods with external and internal threads
1 Plug-in power supply	2 Double clamps
2 Dynamic force sensors	1 Magnetic hooks
1 Eccentric axle motor	1 Bar magnet
1 Induction coil	1 Rubber cord
1 Stopwatch	1 Roll of twine
4 Coil springs	1 Thread eyelet
1 Set of 10 weights, 50 g	1 Squirrel cage ring
1 Base plate	1 Ruler
1 Cross-strut	2 BNC cable, 1 m
2 Stand rods with external threads	1 BNC/4-mm cable

Please ask for quantity discounts on class sets for 8 pieces and more



P-1016652
P-1018476

Includes Instruction for 23 Experiments on Mechanical Oscillations and Waves:

- Determining spring constants (2x)
- Oscillations of a spring pendulum *
- Oscillations of two "identical" spring pendulums * / **
- In-phase and 180° out-of-phase oscillations of two "identical" spring pendulums * / **
- Excitation of a motionless spring pendulum by a moving one * / **
- Superposition of the oscillations of two spring pendulums * / **
- Spring pendulums connected in line * / **
- Spring pendulums connected parallel to one another * / **
- Intrinsic oscillation of a spring pendulum *
- Types of oscillation for a coil spring pendulum *
- String pendulums (2x)
- Seconds pendulums
- Galileo's interrupted pendulum
- Damped oscillations of string pendulums (2x) *
- Standing waves along a rope (2x) *
- Reflection of waves along a rope *

- Speed of propagation of waves along a rope (2x) *
- Oscillation of strings *

Equipment Mechanical Oscillations and Waves:

P-1016652 SEK Mechanical Oscillations and Waves (230 V, 50/60 Hz)

or

P-1018476 SEK Mechanical Oscillations and Waves (115 V, 50/60 Hz)

Dual-channel Oscilloscope, e.g.

P-1017264 USB Oscilloscope 2x50 MHz
(for experiments marked *)

P-1013526 Analogue Multimeter ESCOLA 30
(for experiments marked **)

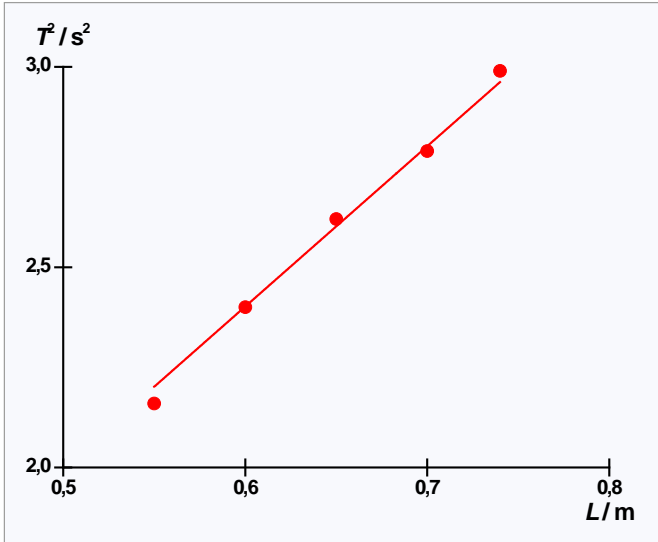

Squares of the period as a function of the length of the pendulum

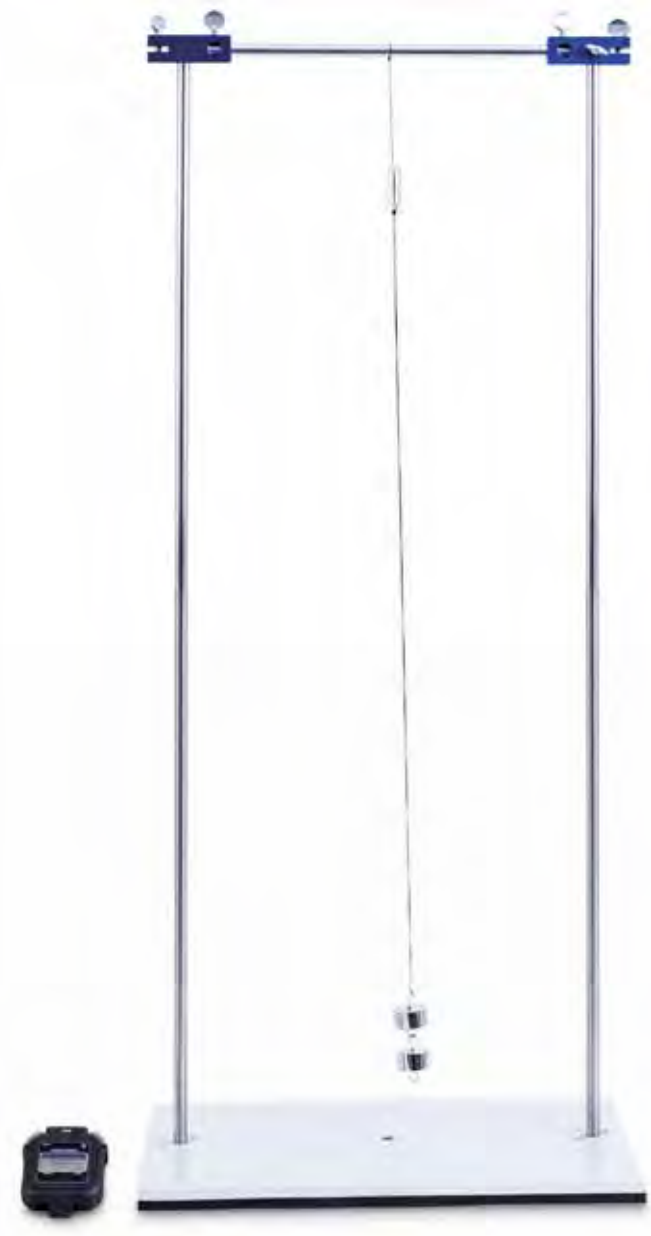

String pendulum

CD-ROM
containing all
different sets of
instructions is
included!

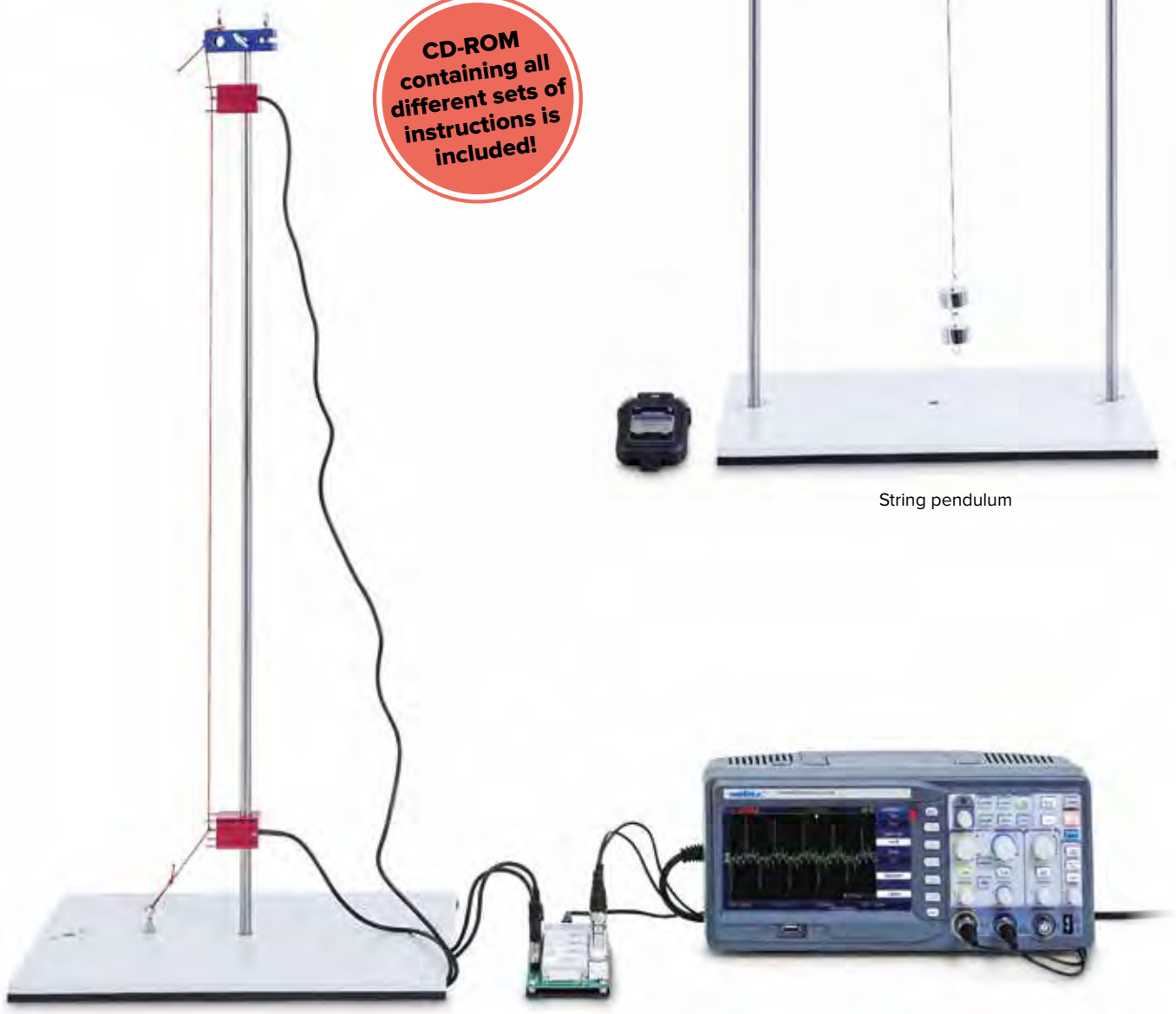

Reflection of waves along a rope

new**SEK – Ultrasonic Waves**

Large equipment set incorporating 30 student experiments for demonstrating the fundamental properties of waves using the example of 40 kHz ultrasonic waves. Stored in a tough Grattnell tray with foam inlay featuring recesses moulded to the shape of the apparatus and covered by a transparent lid. Includes CD with experiment instructions. Includes two ultrasonic transmitters, a rod-shaped microphonic sensor for recording and analysing oscillations using a standard oscilloscope and an ultrasonic pen for recording wave fronts along the desktop in the form of lines of the same phase (isophases). Many of the experiments can also be carried out without using an oscilloscope. In order to measure ultrasonic amplitudes, it is sufficient in many cases to use an analogue voltmeter for alternating current if it has a wide enough frequency range.

Contents:

- 1 Ultrasonic control unit
- 2 Ultrasonic transmitters, 40 kHz
- 1 Ultrasonic pen
- 1 Holder for ultrasonic pen
- 1 Holder base for ultrasonic pen
- 1 Microphone probe
- 2 Beam splitters
- 3 Clamps for beam splitters
- 1 Fresnel zone plate
- 1 Concave mirrors
- 2 Side pieces for double slit/reflectors
- 1 Centre post for double slit
- 1 Clap for double slit
- 1 Ultrasonic absorber
- 2 BNC cables, 1 m
- 1 Cable, BNC/4-mm
- 1 Plug-in power supply

SEK – Ultrasonic Waves (230 V, 50/60 Hz)**P-1016651****SEK – Ultrasonic Waves (115 V, 50/60 Hz)****P-1014529**

**CD-ROM
containing all
different sets of
instructions is
included!**



P-1016651
P-1014529

**Please ask for quantity discounts
on class sets for 8 pieces and more**

Includes Instruction for 30 Experiments on Ultrasonic Waves

- Display of sound oscillations on an oscilloscope *
- Relationship between oscillations and waves *
- Comparison of oscillations at two points along a wave *
- Analysis of phase relationships using an ultrasonic "pen" *
- Determination of wavelength and velocity of sound
- How velocity of sound depends on temperature
- Transmission characteristic of ultrasonic transmitters **
- Resonance curve for ultrasonic transducers *
- Transmission and reflection of ultrasonic waves **
- Absorption of ultrasonic waves **
- Superimposition of sinusoidal oscillations *
- Constructive and destructive reinforcement when sinusoidal oscillations are superimposed *
- Recording of wave fronts using ultrasonic pen
- Generation and detection of straight wave fronts
- Diffraction of ultrasonic waves by an edge
- Diffraction of ultrasonic waves by a single slit
- Interference between two beams **
- Law of reciprocity for interference between two beams **
- Diffraction by a double slit **
- Phase relationships for diffraction by a double slit I *
- Phase relationships for diffraction by a double slit II **
- Formation of images by a spherical concave mirror **
- Plotting of Fresnel zones **
- Formation of images by a Fresnel zone plate **
- Interference of ultrasonic waves by Lloyd's mirror **
- Design of a simple interferometer **
- Design of a Michelson interferometer **
- Elimination of interference by interrupting the path *
- Generation of standing ultrasonic waves **
- Beats in ultrasonic waves *
- Doppler effect in ultrasonic waves

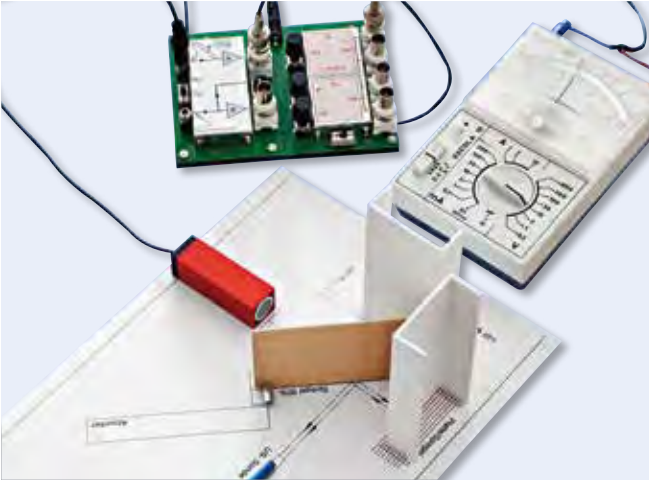

Michelson Interferometer

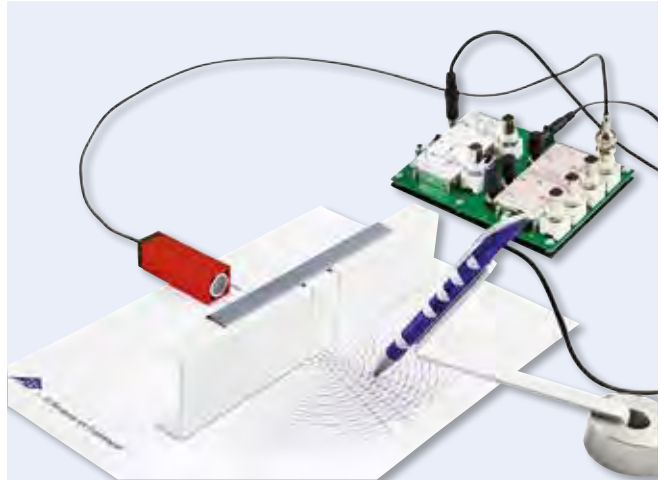

Diffraction by a double slit

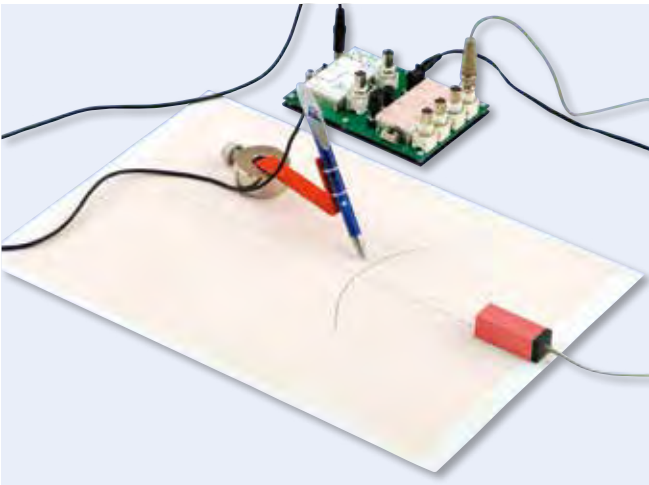

Recording of wave front

Equipment Ultrasonic Waves:

- P-1016651 SEK Ultrasonic Waves (230 V, 50/60 Hz)**
- or
- P-1014529 SEK Ultrasonic Waves (115 V, 50/60 Hz)**

Dual-channel Oscilloscope, e.g.
P-1017264 USB Oscilloscope 2x50 MHz
 (for experiments marked *)

P-1013526 Analogue Multimeter ESCOLA 30
 (for experiments marked **)

Additionally required when using an analogue voltmeter which is unsuitable for measuring alternating voltages of frequencies up to 40 kHz:

P-1018750 Ultrasonic Adapter Lead

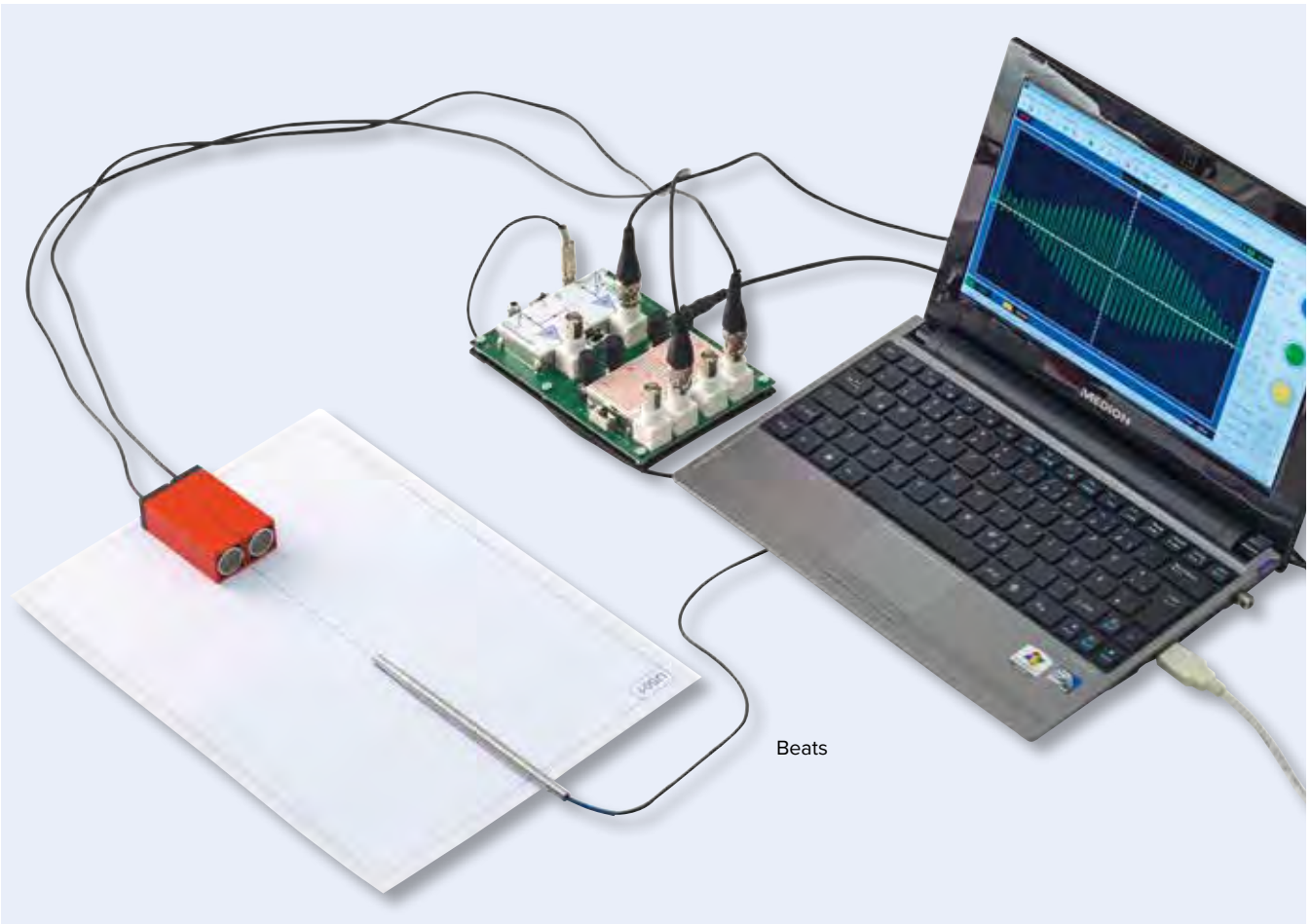

Beats

SEK Radioactivity

Set of apparatus for carrying out 10 basic student experiments on radioactivity. In a robust plastic box with foam inserts moulded to the shapes of the items and a transparent lid. Includes a CD with instructions for the experiments. The experiments are designed to occupy as little space as possible on the supplied base plate, while remaining clear and easy to perform. To determine the count rates, it is recommended that a GAMMASCOUT Geiger counter (P-1002722) be used (not included).

P-1006804**Contents:**

- | | |
|---|--------------------------------------|
| 1 Base plate 340x250 mm | 2 Aluminium plates, 0.5 mm |
| 3 Work templates | 1 Aluminium plate, 1 mm |
| 1 Holder for sources and deflecting magnet | 1 Lead plate, 2 mm, in plastic cover |
| 1 Deflecting magnet | |
| 1 Thorium irradiation module (weld filler wire) | |



Please ask for quantity discounts on class sets for 8 pieces and more

Includes 10 Experiments on the Subject of Radioactivity:

- Determining background radiation
- Determining pulse rates for various radioactive preparations
- Statistical distribution of counter pulses
- Determination of equivalent dose for various radioactive preparations
- Penetrative capacity and range of radiation
- Deflection of alpha and beta radiation by a magnetic field*
- Absorption of alpha rays*
- Absorption of beta rays*
- Absorption of gamma rays*
- Inverse square law

Equipment Radioactivity:

P-1006804 SEK Radioactivity

P-1002722 Geiger Counter GAMMASCOUT

*additionally required:

P-1006797 Radiation Cartridge ^{226}Ra 4 kBq



Deflection of alpha and beta radiation by a magnetic field

Geiger Counter

Versatile, easy to use and compact precision instrument for measuring α -, β - and γ -radiation. With filter selection switch at the front of the Geiger-Müller counter tube for filtering out types of radiation (γ/β , $\gamma/\alpha/\beta$ or γ only), large display and integrated USB interface. Including USB cable, Windows software, and operating instructions. The following functions and operating modes are available for measurement:

- Standard mode for displaying the current radiation level. Display of the equivalent dose as a numerical value and a bar chart and display of the time until a selected cumulative dose limit is reached (default 5 $\mu\text{Sv/h}$). Also equipped with variable acoustic and optical warning threshold signal and display of average radiation from previous day.
- Pulse counting either permanent or with variable gate time. Gate time adjustable in seconds, minute or hours. Additional optional acoustic count indication.
- Count rate measurement. The pulses registered are measured successively and converted into a count rate (number of pulses per second).
- Integrated display of date and time for correct recording of measured radiation.
- The number of pulses registered is stored in the internal memory. This facilitates recording e.g. of weekly values for up to 10 years.
- Computer docking station. The software enables the measured data to be evaluated and processed on an MS-Windows PC.

Radiation types: α from 4 MeV, β from 0.2 MeV, γ from 0.02 MeV

Measured variables: equivalent dose in Sv/h, mSv/h, $\mu\text{Sv/h}$
pulses/s, pulses/variable time interval

Display: LCD, 4 digit, numerical with display of measured variable, quasi analogue bar chart, operating mode indicators

Radiation detector: End window Geiger-Müller counter tube, stainless steel housing with neon-halogen filling

Measuring length: 38.1 mm

Measuring diameter: 9.1 mm

Mica window: 1.5 – 2 mg/cm^2

Gamma sensitivity: 114 pulses/min for ^{60}Co radiation = 1 $\mu\text{Sv/h}$ in background radiation energy band

Background rate: 10 pulses per minute approx.

Internal memory: 2 kilobytes

Battery life: 3 years approx.

Dimensions: 163x72x30 mm^3 approx.

Weight: 155 g approx.

P-1002722



P-1002722

SEK Radioactivity



Absorption of beta radiation from the thorium cartridge

Student Experiments

CD-ROM containing all different sets of instructions is included!



P-1006797

Note:

Due to the special delivery conditions applying to radiation cartridges, transport costs are higher than usual.

Radiation Cartridge, ^{226}Ra , 4 kBq

Regulation-exempt radiation source with brass container for shielding. Radium sulphate rolled in gold foil and sealed at one end of a stainless steel cartridge.

Activity: 4 kBq

Weight: 400 g approx.

P-1006797

new

SEK Solar Energy

Large equipment set for carrying out 23 fundamental experiments on solar energy. The basic parameters and properties of solar modules and the aspects which affect their energy efficiency can all be demonstrated by experiment. Contained in a rugged metal case including foam inlay with recesses in the shape of the apparatus. The system allows you to assemble experiments easily and in a compact set-up on or in the lid of the kit's carry case. Includes CD with experiment instructions.

SEK Solar Energy (230 V, 50/60 Hz)

P-1017732

SEK Solar Energy (115 V, 50/60 Hz)

P-1017731

Contents:

1 Halogen spotlight	1 Jumper
2 Solar modules	1 Set of experiment leads
2 Digital multimeters	1 Cross piece
1 Lux meter	1 Support brace
1 Digital thermometer	1 Set of items for covering modules
1 Terminal board with resistor cascade	1 Case
1 Power adjuster	

CD-ROM containing all different sets of instructions is included!



P-1017732
P-1017731

Includes instruction for 16 Experiments on Solar Energy:

- Illuminance of various light sources
- Parameters affecting the power generated by a solar module
- Shading of solar modules connected in series
- Effect of shading on the terminal voltage of a solar module
- Effect of illuminance on the open-circuit voltage and short-circuit current for a solar module
- Effect of angle of incidence on the open-circuit voltage and short-circuit current for a solar module
- Open-circuit voltage and short-circuit current for solar modules connected in series and in parallel
- Current-voltage characteristic for a solar module
- Current-voltage characteristic for solar modules in series
- Current-voltage characteristic for solar modules in parallel
- Optimum load resistance when the angle of incidence changes
- How the open-circuit voltage and short-circuit current for a solar module depend on temperature
- How power output from solar modules depends on temperature
- Voltage-current characteristic for illuminated and non-illuminated solar modules *
- Setting up a stand-alone power supply network **
- Energy conversion ***

Equipment Solar Energy:

P-1017732 SEK Solar Energy (230 V, 50/60 Hz)

or

P-1017731 SEK Solar Energy (115 V, 50/60 Hz)

P-1003312 DC Power Supply 0-20 V (230 V, 50/60 Hz)

or

P-1003311 DC Power Supply 0-20 V (115 V, 50/60 Hz)

(for experiments marked *)

P-1017734 Coulombmeter with Rechargeable Battery

P-1002811 Digital Stopwatch

(for experiments marked **)

P-1017735 Geared Motor with Pulley

P-1018597 Set of Weights 1 g to 500 g, slotted with Holder

P-1007112 Experiment Cord

P-1002811 Digital Stopwatch

(for experiments marked ***)

new

Coulombmeter with Rechargeable Battery

Coulombmeter for measuring the flow of current when storing energy in a rechargeable battery. Charge or consumption can be displayed by means of a voltmeter. Depending on the measuring range selected, 1 V on the voltmeter corresponds to either 0.1, 1 or 10 ampere seconds (As).

- Measuring ranges: 1/10/100 As (max. measurable charge ± 499 As)
- Power supply: 9 V rechargeable battery via DC co-axial power socket
- Load current: max. 500 mA
- Charging current for battery: max. 50 mA
- External power source: Solar panel or DC power supply (max. 12 V DC) with current limiting to 50 mA when there is no load on the coulombmeter
- Connectors: 4-mm safety sockets
- Dimensions: 105x75x45 mm³ approx.
- Weight: 200 g including rechargeable battery and housing

P-1017734



P-1017734

new

Geared Motor with Pulley

The geared motor with string pulley is used in conjunction with the Solar Energy Student Experiment Kit as a load for demonstrating conversion of energy. The motor is mounted on a base plate and has a pulley attached for a string. Power is supplied via 4-mm safety sockets. Weights of up to approximately 1 kg can be lifted.

- Power supply: max. 12 V DC
- Load current: max. 50 mA
- Torque: 0.41 Nm
- Speed: 76.1 rpm with no load
- Connectors: 4-mm safety sockets
- Dimensions: 105x75x45 mm³ approx.
- Weight: 220 g approx.

P-1017735



P-1017735

Please ask for quantity discounts on class sets for 8 pieces and more

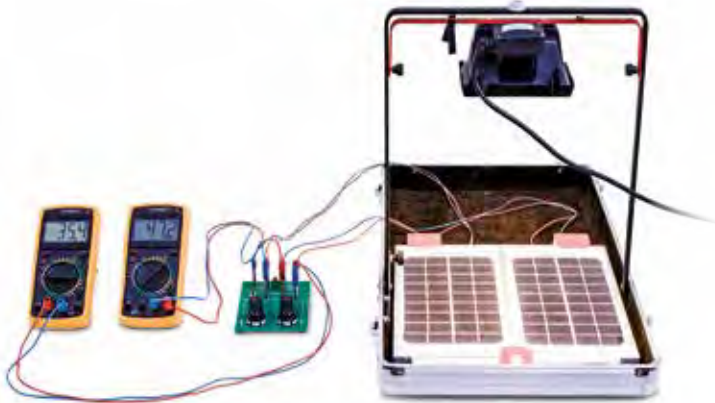

Current-voltage characteristic for solar modules in series

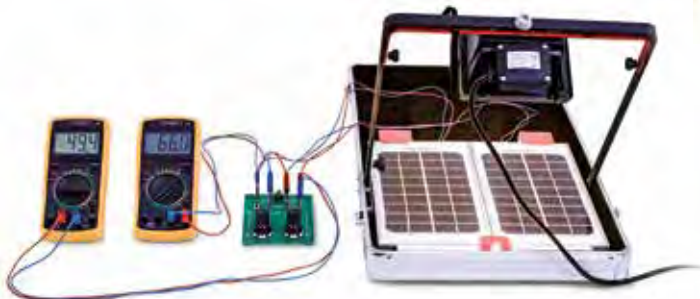

Optimum load resistance when the angle of incidence changes



How power output from solar modules depends on temperature

Kröncke Optical System for Student Exercises

The Kröncke optical system provides robust reliability that has been tried and tested for decades and offers all the precision needed for student exercises and practical courses in numerous experiments on ray and wave optics. The experiments are carried out in traditional fashion using the white light of an incandescent lamp, the filament of which can be projected through an adjustable slit to observe interference in particular.

All optical components are mounted in diaphragms with no stems and can easily be adjusted vertically and with precision into the optical light path when mounted on optical riders. Optical riders can freely move on the U-profile rail of an optical bench and can be attached with a minimum of force.

Basic Set for Kröncke Optical System

Contents:

- 1 Optical lamp
- 1 Transformer 12 V, 25 VA
- 1 Optical bench, 1000 mm
- 6 Optical slides
- 2 Clamps
- 2 Converging lenses, $f = 50$ mm
- 2 Converging lenses, $f = 100$ mm
- 2 Converging lenses, $f = 150$ mm
- 1 Converging lens, $f = 300$ mm
- 1 Converging lens, $f = 500$ mm
- 1 Diverging lens, $f = -100$ mm
- 1 Diverging lens, $f = -500$ mm
- 1 Diaphragm with 1 slit
- 1 Diaphragm with 3 slits
- 1 Photograph in slide frame
- 1 Transparent screen
- 1 White screen
- 1 Set of 4 colour filters
- 1 Ruler, 15 mm
- 1 Set of holes arranged to form the number "1"
- 1 Pinhole aperture, $d = 1$ mm
- 1 Pinhole aperture, $d = 6$ mm

Please ask for quantity discounts on class sets for 8 pieces and more



Basic Set for Kröncke Optical System (230 V, 50/60 Hz)

P-1009932

Basic Set for Kröncke Optical System (115 V, 50/60 Hz)

P-1009931



Diffraction by a multiple slit

2m

Includes 12 Experiments on the Subject of Ray Optics:

- Pinhole camera
- Imaging with converging lenses
- Image aberrations
- Images in the eye (eye model)
- Correction of vision
- Magnifying glasses
- Microscopes
- Astronomical telescopes
- Terrestrial telescopes
- Slide projectors

CD-ROM containing all different sets of instructions is included!

Equipment Ray Optics:

P-1009932 Basic Set for Kröncke Optical System (230 V, 50/60 Hz) or

P-1009931 Basic Set for Kröncke Optical System (115 V, 50/60 Hz)



Slide projector



Visibility of polarised light in turbid water

Includes 3 Experiments on the Subject of Polarisation:

- Polarisation of transverse waves
- Polariser and analyser
- Visibility of polarised light in turbid water
- Double refraction
- Rotation of planes of polarisation by a sugar solution

Equipment Polarisation:

- P-1009932 Basic Set for Kröncke Optical System (230 V, 50/60 Hz) or
- P-1009931 Basic Set for Kröncke Optical System (115 V, 50/60 Hz)
- P-1009701 Supplementary Set for Polarisation



P-1009701

Supplementary Set for Polarisation

Supplementary set to the Kröncke optics basic set (P-1009932 or P-1009931) for carrying out student experiments on the polarisation of light waves.

Contents:

- 1 Pair of polarising filters
- 1 Pinhole aperture, 10 mm
- 1 Rectangular cuvette

P-1009701



P-1009700

Supplementary Set for Interference

Supplementary set to the Kröncke optics basic set (P-1009932 or P-1009931) for carrying out student experiments on the interference of light waves.

Contents:

- 1 Optical bench, 500 mm
- 1 Adjustable slit
- 1 Diaphragm with 9 circular discs
- 1 Diaphragm with 9 circular holes
- 1 Diaphragm with 3 individual slits and 1 double slit
- 1 Diaphragm with 4 multiple slits and grating
- 1 Diaphragm with 3 ruled gratings
- 1 Micrometer screw
- 1 Fresnel mirror

P-1009700

Includes 10 Experiments on the Subject of Interferences:

- Fresnel mirror
- Diffraction by small openings and plates
- Diffraction by an air gap
- Diffraction by the wire
- Diffraction by multiple slits
- Diffraction by the grating
- Optical resolution
- Determining the wavelength of light

Equipment Interference:

- P-1009932 Basic Set for Kröncke Optical System (230 V, 50/60 Hz) or
- P-1009931 Basic Set for Kröncke Optical System (115 V, 50/60 Hz)
- P-1009700 Supplementary Set for Interference

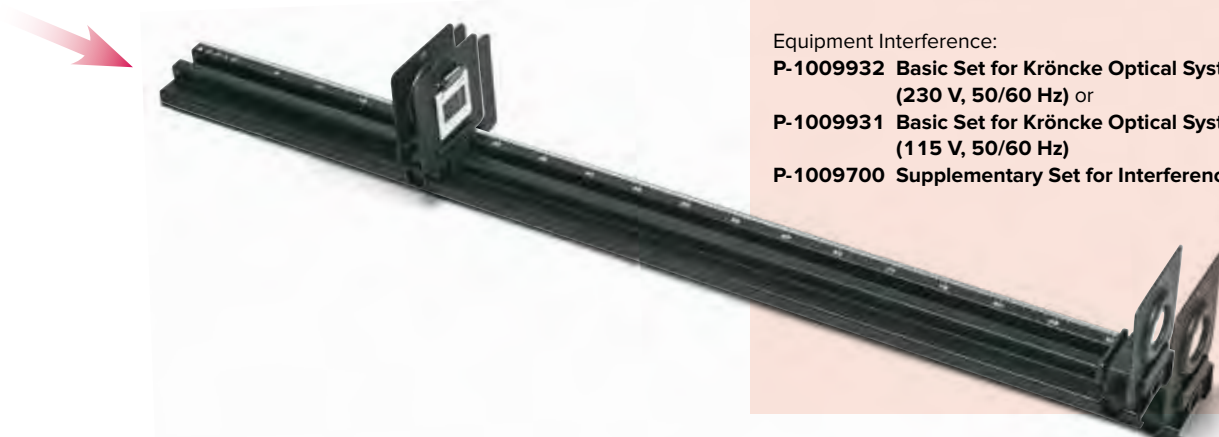

Experiment Topics:

- Displacement-time graphs
- Linear gradients
- Velocity

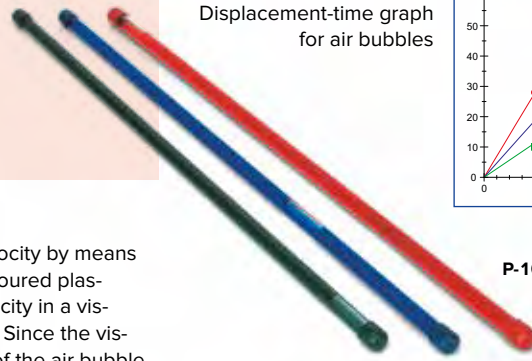

Displacement-time graph for air bubbles

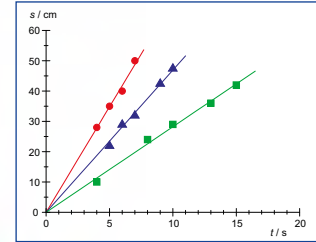

P-1003502

Constant Velocity Student Kit, 3 Tubes

Set of equipment for investigating the concept of velocity by means of student experiments. Consisting of three small coloured plastic tubes in which an air bubble rises at constant velocity in a viscous liquid, provided the tubes are aligned vertically. Since the viscosities differ, the velocities also differ. The position of the air bubble is plotted against time. The three different resulting straight lines lead to a definition of velocity.

Length: 500 mm approx.
Diameter: 13 mm approx.

P-1003502

Additionally required:

- P-1003369 Mechanical Stop Watch, 15 min
- P-1002603 Pocket Measuring Tape, 2 m

! Advantage

- It is possible to demonstrate both positive and negative velocities.

Constant Velocity Student Kit, 4 Tubes

Set of equipment for investigating the concept of velocity by means of student experiments. It consists of one transparent and three coloured plastic tubes. In the coloured tubes an air bubble rises with constant speed in a viscous fluid as soon as the tube is held vertical. Since the viscosities inside the tubes differ, the velocities with which the bubbles rise in each of them are also different. The transparent tube also contains a plastic ball and a metal ball which sink down the tube thus demonstrating negative velocities. The positions of the bubble or the balls are plotted on a graph. The gradients of the various resulting straight lines lead to a definition of velocity.

Length: 830 mm approx.
Diameter: 13 mm approx.

P-1018624

Additionally required:

- P-1003369 Mechanical Stop Watch, 15 min
- P-1002603 Pocket Measuring Tape, 2 m

Displacement-time graph for air bubbles and the balls

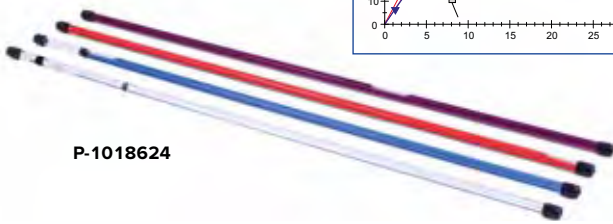
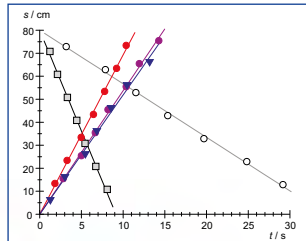

P-1018624

Experiment Topics:

- Determining mass of evacuated air and density of air
- Effect of air pressure on a slightly inflated hot-air balloon and on a suction cap
- Lowering of the boiling point of liquids at decreased air pressure

Vacuum Student Kit

Set of equipment for introducing the fundamentals of vacuum physics by means of student experiments.

Contents:

- 1 Experiment plate with washer
- 1 Vacuum bell jar
- 1 Beaker
- 1 Pressure hose with check valve
- 1 Pressure hose with T-connector and check valve
- 1 Simple hand pump in storage container
- 1 Suction cap
- 2 Balloons

P-1003494

Additionally recommended:

- P-1009772 Electronic Scales Scout Pro 200 g

Effect of air pressure on a slightly inflated balloon

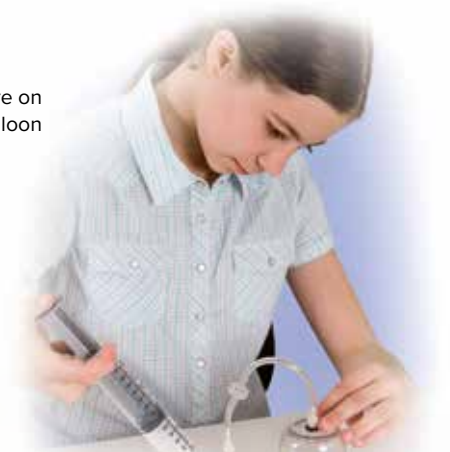

P-1003494

Experiment Topics:

Colours:

- Coloured light and coloured objects
- Mixture of colours

Shadows:

- Casting shadows
- Coloured shadows

Reflection:

- Reflection from a plane mirror
- Reflected images, image reversal
- Multiple reflections from a mirror
- Reflection from a concave mirror (focal point and spherical aberration)
- Reflection from a parabolic mirror
- Reflection from a convex mirror

Refraction:

- Determining refractive index with a semi-circular object
- Determining refractive index with a parallel block
- Angle of minimum deflection for a prism
- Total internal reflection in a semi-circular object
- Total internal reflection in a prism
- Focal point of a converging lens
- Focal point of a diverging lens
- Spherical aberration



P-1003209

Light Box

Set of equipment for optical experiments to be carried out on a table, consisting of a light box in a sturdy plastic housing and numerous optical components. Complete set in sturdy wooden storage case. The light box has four light outlets: the two side outlets have two hinged mirrors for experiments on colour mixing and shadows. All openings are equipped with mounts for optical components in 50x50 mm² slide frames. Parallel, convergent and divergent light can be generated by adjusting a converging lens attached in front of the lamp. There are two double-sided slit diaphragms available so that four different beam configurations can be created.

Lamp:	12 V, 36 W
Connections:	4-mm socket
Light box:	175x100x65 mm ³ approx.
Storage case:	250x240x100 mm ³ approx.

P-1003209

Additionally required:

P-1000593 Transformer 12 V, 60 VA (230 V, 50/60 Hz)

or

P-1006780 Transformer 12 V, 60 VA (115 V, 50/60 Hz)

Contents:

1 Light box	1 Semi-circular object (transparent acrylic)
8 Colour charts	1 60° prism (transparent acrylic)
1 Plane mirror (glass)	1 Asymmetrical 90° prism (transparent acrylic)
1 Concave mirror (metal)	1 Symmetrical 90° prism (transparent acrylic)
1 Convex mirror (metal)	2 Slit diaphragms
1 Bi-convex lens, large (transparent acrylic)	8 Colour filters (in slide frame)
1 Bi-convex lens, small (transparent acrylic)	1 Pair of connector leads with 4-mm plugs
1 Bi-concave lens (transparent acrylic)	1 Spare lamp
1 Parallel plate (transparent acrylic)	

Spare Lamp for Light Box (not shown)

Spare lamp for light box, 12 V, 36 W.

P-1003231

The experiment system for fuel cells allows students to gradually investigate the world of fuel cells and solar-hydrogen technology in many illustrative and quantitative experiments.

Experiment Topics:

- Current-voltage curve of a solar cell.
- Power curve and efficiency of a solar cell.
- Current-voltage curve of a PEM electrolyser
- Energy efficiency and Faraday efficiency of a PEM electrolyser
- Current-voltage curve of a PEM fuel cell
- Power curve of a PEM fuel cell

Contents:

- 1 Solar-hydrogen cell system consisting of solar module, PEM electrolyser, hydrogen and oxygen reservoirs, PEM fuel cell and fan
- 1 Resistor decade with maximum load capacity of 1 W
- 2 Multimeters
- 3 Connector leads, 50 cm, red
- 3 Connector leads, 50 cm, black
- 1 Stop watch
- 250 ml Distilled water
- 1 Storage case

P-1013904



P-1013904

Fuel Cell Experiment System

Solar-hydrogen cell system and accessories for carrying out student experiments. In a tough plastic box with foam inlay.



P-1013904

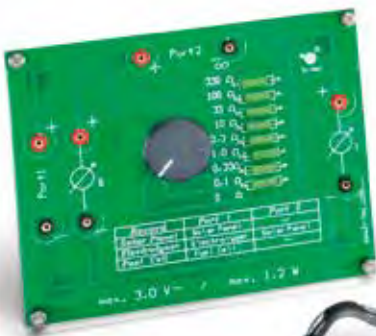

Enhance your lessons with a multitude of easily conducted experiments using the GASTEC gas detector.

Experiments:

Analysis of stuffy and of fresh air in a room.

Investigation of how carbon dioxide and oxygen content changes in the atmosphere due to the following processes:

- Burning of a candle.
- Breathing of people and animals.
- Photosynthesis of plants.
- Burning of organic substances.

Gas Analysis Made Child's Play:

- Open glass test tube using the tip to break off both ends and close the ends using protective rubber stoppers.
- Push the test tube into the hand pump and hold it at the required position.
- Suck air into the tube using the pump and wait 30 seconds.
- Take the test tube out of the hand pump and read off the gas content from the degree of coloration.



Basic Student Experiments

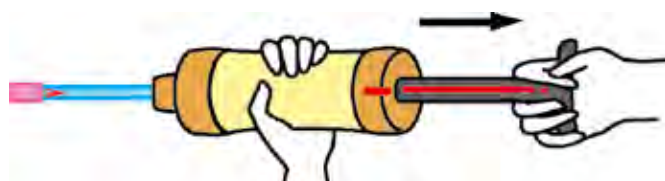

Set of 10 CO₂ Test Tubes, 0.03 – 1.00% by vol. (not shown)
Set of 10 test tubes for the GASTEC gas detector, used for detecting changes in carbon dioxide content in the atmosphere due to combustion processes, for comparison of fresh and stuffy air or observing photosynthesis in plants.

P-1012524

Set of 10 CO₂ Test Tubes, 0.5 – 8.0% by vol. (not shown)
Set of 10 test tubes for the GASTEC gas detector, used for detecting changes in carbon dioxide content in the atmosphere due to combustion of organic materials or the breathing of people and animals.

P-1012526

Set of 10 O₂ Test Tubes, 6 – 24% by vol. (not shown)
Set of 10 test tubes for the GASTEC gas detector, used for detecting oxygen content of air in the atmosphere.

P-1012527

Set of 10 Pairs of Protective Rubber Stoppers (not shown)
Set of spares including 10 pairs of protective rubber stoppers for test tubes used with the GASTEC gas detector.

P-1012528

GASTEC Gas Detector

Easy to use gas detector for analysing gas content in the atmosphere. For use in countless fundamental experiments. Includes hand pump and accessories for pumping air into specific test tubes, from which the gas content can be read off by means of the degree of colouration of the adsorption material.

Contents:

- 1 Hand pump for pumping in samples
- 1 Break-off tip for test tubes
- 1 Set of 10 pairs of protective rubber stoppers
- 1 Sealing grease
- 1 Carrying case
- 1 Teaching poster with suggested experiments, many illustrations and detailed instructions

P-1012504

Additionally required:

- P-1012524 Set of 10 CO₂ Test Tubes, 0.03 – 1.00% by vol.**
- or
- P-1012526 Set of 10 CO₂ Test Tubes, 0.5 – 8.0% by vol.**
- or
- P-1012527 Set of 10 O₂ Test Tubes, 6 – 24% by vol.**



P-1012504

Student Experiments

3B NETlab™:

- Comprehensive range of data processing functions, including tangents, integration, curve matching, all kinds of formula calculations and interpolation.
- Data acquisition with date and time of each measurement.
- Recording and processing several series of measurements.
- Presentation of data in the form of graphs or tables, analogue or digital multimeter functions.
- Easy configuration of sensor and experiments on the basis of predefined experiment files.
- Text windows for comments about the experiment.
- Support for analogue and digital sensors.
- Automatic identification of sensors.

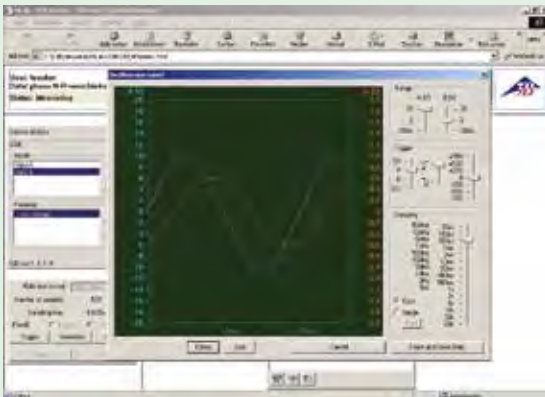

Oscilloscope: Voltage phase shift in RL series resonant circuit

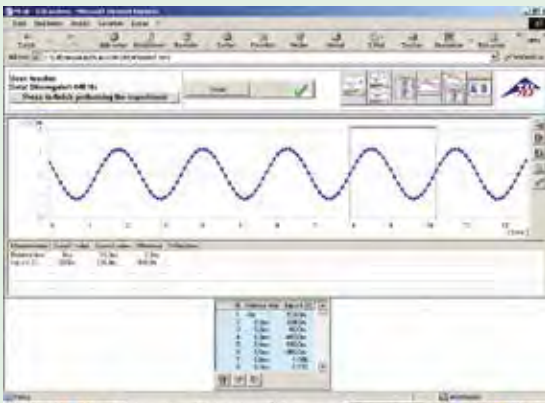

Sound amplitude of a tuning fork as a function of time

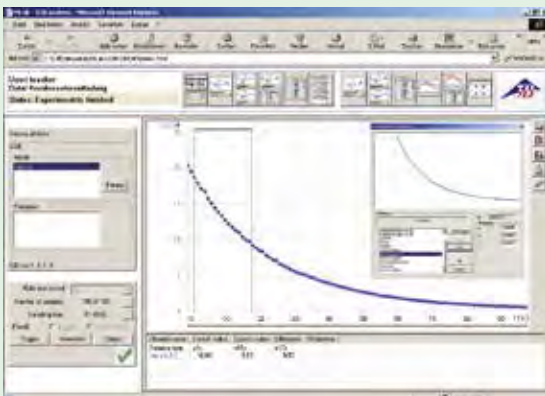

Discharge curve of a capacitor

**3B NETlab™**

3B NETlab™ is a data acquisition and data processing program for the 3B NETlog™ interface that can also be operated in a network. As it is based on ActiveX technology, all the available functions can be integrated into web pages that can be displayed and used with the Microsoft Internet Explorer browser. The main function of 3B NETlab™ is computer aided experimentation for science education. For that purpose, a large number of experiment instructions are available in the form of web pages. Users can navigate through these in the same way as they would browse the Internet and all the operations can be controlled with the help of facilities incorporated into the web pages at appropriate points. Experiment Instructions for carrying out experiments can also be written by teachers using standard HTML tools and the programming environment made available for the purpose. All kinds of Internet tools and technologies, such as multimedia sequences, animations, films, etc. can be incorporated into the experiment files. A software measuring lab is available for solo experimentation that utilizes all the functions of the functions of 3B NETlog™ interface device. A wide range of graphical tools is available for processing experimental data. Thanks to its networking capability, 3B NETlab™ is ideally suited for use in schools. It enables teachers to check on the status and results of students' experiments from their own desk. Conversely, an experiment that is being carried out by the teacher can be followed by students on their own monitor screens.

P-1000544.....

Licensing:

3B NETlab™ contains a specified location license for the normal use of the computer program throughout a school or educational establishment, including the preparation of school or student work at home.

System requirements:

Windows XP and Microsoft Internet Explorer up to version 8
 Windows 7 (32-bit and 64-bit) and Microsoft Internet Explorer up to 11 or higher
 Windows 8.1 (32-bit und 64-bit) and Microsoft Internet Explorer up to 11 or higher
 32-bit (x86) or 64-bit (x64) processor with a speed of at least 1 GHz
 At least 1 GB RAM
 At least 500 MB hard disc memory
 Monitor with a resolution of 1024x768 pixels or higher
 USB port

3B NET/log™

3B NET/log™ can be used as an interface for data acquisition linked to a computer, or as a hand held instrument with a data-logger for measurements of current and voltage or in combination with various sensors. It incorporates sensor connectors with automatic identification of sensors. It can be connected to a computer via USB. Can optionally be connected via Ethernet to the same sub-net of an Intranet. Includes USB cable and installation CD with data transfer program and plug in power supply.

- Channels: 2 Differential amplifiers (A and B)
- Measuring ranges: 0 – ±200 mV, 0 – ±2 V, 0 – ±20 V
- Connectors: Two twin 4 mm safety sockets
- Current input:
 - Channel: Parallel to A
 - Measuring ranges: 0 – ±200 mA, 0 – ±2 A
 - Connector: One twin 4 mm safety socket
- Analogue sensor inputs:
 - Channels: 2 (A and B)
 - Connectors: Two 8-pin miniDIN sockets
 - Sensor identification and calibration: Automatic
 - Triggering: Quasi-continuous
 - Sampling rate: 50 kilosamples/s
 - Resolution: 12 bit
- Voltage outputs:
 - Channels: 2 (A' and B'), with common ground connection
 - Voltage amplitude: 0 – ±5 V
 - Connectors: Two twin 4 mm safety sockets
- Analogue sensor outputs:
 - Channels: 2 (A' und B')
 - Connectors: Two 8-pin miniDIN sockets
 - Sampling rate: 10 kilosamples/s
 - Resolution: 12 bit

- Digital Inputs:
 - Channels: 4 (A, B, C, D)
 - A: TTL
 - B: TTL, high-speed sampling rate, 100 kilosamples/s
 - C, D: High-speed optical coupler (galvanically isolated)
 - Connector: One 8-pin miniDIN socket
- Digital outputs:
 - Channels: 6 (A', B', C', D', E', F')
 - Signal: TTL
 - Connector: One 8-pin miniDIN socket
- Additional data:
 - Computer connection: USB port
 - Internal data storage: 128 k
 - Monitor display: Large display (64x122) for data on all channels
- Power supply: 4.5 V DC/300 mA or 3 batteries LR6 AA alternatively 3 NiCd or 3 NiMH rechargeable batteries

3B NET/log™ (230 V, 50/60 Hz)

P-1000540

3B NET/log™ (115 V, 50/60 Hz)

P-1000539

3B NET/log™ with Ethernet Port (230 V, 50/60 Hz)

P-1000009

3B NET/log™ with Ethernet Port (115 V, 50/60 Hz)

P-1000541





P-1009955
P-1009954

P-1001034



P-1000563

Photo Gate

Infra-red photo gate for triggering the 3B NET/og™ unit (P-1000540 or P-1000539) or a digital counter (P-1001033 or P-1001032). For time measurements in experiments on free fall, motion on a track or pendulum oscillations and for counting pulses. It can be operated in internal mode using the built-in infra-red light source or in external mode with the aid of a laser pointer, which needs to be obtained separately. It then acts as a wide-range light barrier, allowing it to be used at sporting events, for example. The gate includes an operational indicator light, stand rod with screw thread, M6 bolt for attachment to a roller track (P-1018102) and connector lead with 8 pin miniDIN plugs.

Barrier spacing:	82 mm
Rise time:	60 ns
Spatial resolution:	< 1 mm
Time resolution:	0.1 ms
Dimensions (without rod):	120x80x22 mm ³

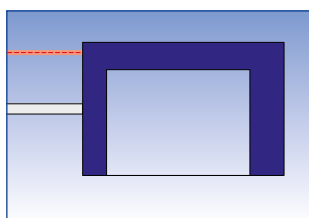

P-1000563

Additionally required for attaching multiple light barriers to 3B NET/og™ unit:

P-1000571 Digital Input Box

Also recommended for use connecting of photo gate to external digital counters:

P-1009955 Connector Box (230 V, 50/60 Hz)

P-1009954 Connector Box (115 V, 50/60 Hz)

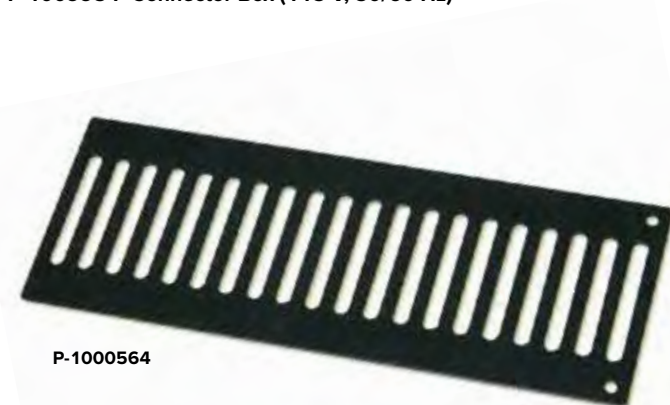

P-1000564

Connector Box

Connector box for use in connecting light barrier (P-1000563) or laser reflection sensor (P-1001034) to external digital counters. Includes plug-in power supply 12 V AC.

Input: 8-pin miniDIN socket
Output: Two 4-mm safety sockets

Connector Box (230 V, 50/60 Hz)

P-1009955

Connector Box (115 V, 50/60 Hz)

P-1009954

Laser Reflection Sensor

Sensor for triggering the 3B NET/og™ unit (P-1000540 or P-1000539) or a digital counter (P-1001033 or P-1001032) in time measurements on moving objects. Suitable for opto electronic scanning of light and dark markings on moving objects or in conjunction with a reflecting foil to form a wide spaced obstruction sensor. The intensity of the laser beam is adjusted automatically according to the distance of the object. Includes reflecting foil, stand rod with screw thread and connector lead with 8-pin miniDIN plugs.

Maximum range: 2.5 m
Laser power: <1 mW
Laser protection class: II

P-1001034

Additionally required for attaching multiple laser reflection sensors to 3B NET/og™ unit:

P-1000571 Digital Input Box

Also recommended for use connecting laser reflection sensor to external digital counters:

P-1009955 Connector Box (230 V, 50/60 Hz)

P-1009954 Connector Box (115 V, 50/60 Hz)

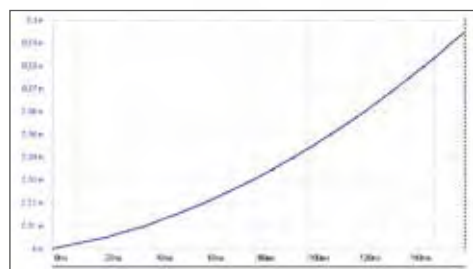

Distance travelled as a function of time

Picket Fence

Aluminium strip with 21 openings for determining gravitational acceleration g from time intervals recorded for a light beam passing through the individual openings of the strip as it falls freely past the beam. Anodised sheet aluminium with two holes for suspension of additional weights to demonstrate that the acceleration is independent of the mass.

Distance between rungs: 10 mm
Dimensions: 205x75 mm² approx.

P-1000564

Measurement of free fall using a picket fence

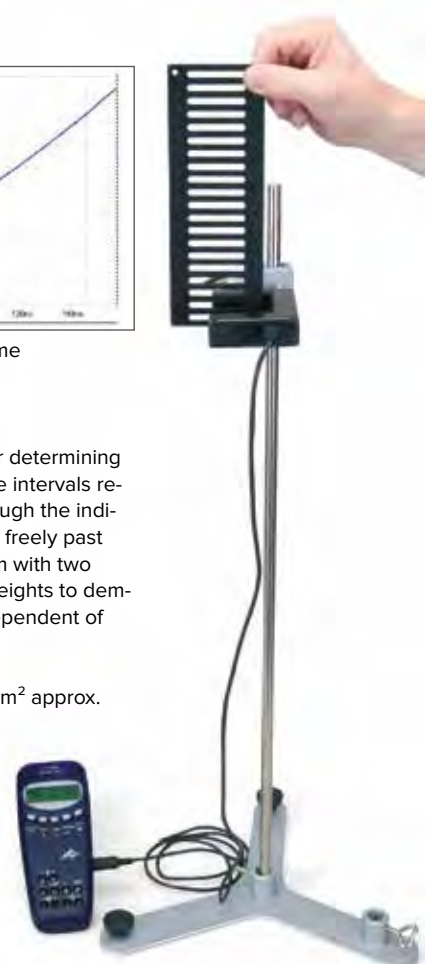



P-1000559

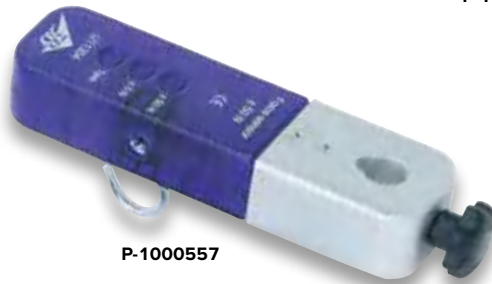

P-1000568

P-1000557



Ultrasonic Motion Sensor

Sensor for the measurement of unidimensional motion, e.g. on an air cushion track or in free fall. Can be used in conjunction with a 3B NET/og™ unit (P-1000540 or P-1000539) for manual measurements or for processing measurement data when connected to a computer. Includes connector lead with 8-pin miniDIN plugs and grill for protection against falling objects.

Measurement range: 0.15 m to about 11 m
 Resolution: 2 mm
 Accuracy: ±1%
 Sensor type: Electrostatic 50 kHz converter
 Sampling frequency: 10 Hz

P-1000559

Acceleration Sensor, ±25g

Sensor for the measurement of unidimensional collisions and all kinds of high acceleration motion. Can be used in conjunction with 3B NET/og™ unit (P-1000540 or P-1000539) for manual measurements or for processing measurement data when connected to a computer. Includes connector lead with 8 pin miniDIN plugs.

Measurement range: 0 – ±250 m/s²
 Resolution: 0.2 m/s²
 Accuracy: ±1%
 Sensor cable: 2 m
 Sensor type: Capacitive acceleration sensor

P-1000560



P-1000560

P-1000561

Acceleration Sensor, ±5g

Sensor for the measurement of unidimensional acceleration, e.g. of a rider on an air cushion track, of a coil spring pendulum or of a lift. Can be used in conjunction with 3B NET/og™ unit (P-1000540 or P-1000539) for manual measurements or for processing measurement data when connected to a computer. Includes connector lead with 8-pin miniDIN plugs.

Measurement range: 0 – ±50 m/s²
 Resolution: 0.03 m/s²
 Accuracy: ±1%
 Sensor cable: 2 m
 Sensor type: Capacitive acceleration sensor

P-1000561

Displacement Sensor

Sensor with rotating wheel for detecting displacement via a string. Includes stand rod with thread and connector lead with 8-pin miniDIN plugs.

Wheel: 24 mm diam.
 Maximum displacement: 66 mm approx.
 Displacement resolution: 1/8 mm approx.

P-1000568

Force Sensor, ±50 N

Force sensor for the measurement of unidimensional forces, with tare function. Can be used in conjunction with a 3B NET/og™ unit (P-1000540 or P-1000539) for manual measurements or for processing measurement data when connected to a computer. Includes connector lead with 8 pin miniDIN plugs.

Measurement ranges: 0 – ±5 N, 0 – ±50 N
 Accuracy: ±1%
 Sensor type: Metal strip strain gauges

P-1000557

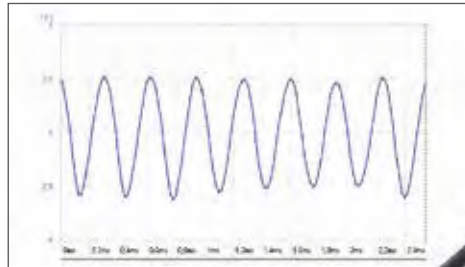

Sound amplitude of a tuning fork as a function of time



P-1000565

Microphone

Sensor for the measurement of the relative acoustic pressure or for plotting sound wave patterns, e.g. of voices or musical instruments. With built in electret microphone. Can be used in conjunction with a 3B NET/og™ unit (P-1000540 or P-1000539) for manual measurements or for processing measurement data when connected to a computer. Includes connector lead with 8 pin miniDIN plugs.

Frequency range: 50 Hz – 20 kHz
 Microphone cable: 2 m

P-1000565

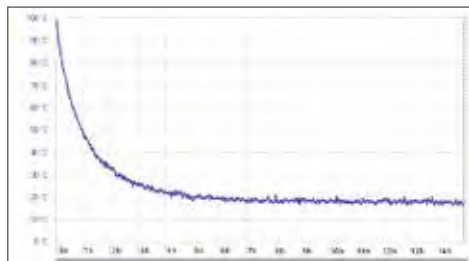

Fall in temperature as a function of time



Demonstration of Newton's law of cooling

UV-A/B Sensor

Sensor box with built-in photodiode for measurements in the UV A / UV B spectra. For use in conjunction with 3B NET/log™ unit (P-1000540 or P-1000539) for manual measurements or measurement acquisition via computer. Includes screw-in aperture, UV-A filter (SCHOTT UG-1) and connector lead with 8-pin miniDIN plugs.

Measuring ranges: 0 – 70 mW/m², 0 – 7 W/m², 0 – 700 W/m²

Max. spectral sensitivity: 21 mA/W approx. at 300 nm

Filter level

for visible light: 50

Sensor type: Titanium dioxide Schottky diode with built-in filter for visible light

P-1000567



P-1000558

Temperature Sensor, TC – K

Temperature sensor for the measurement of extremely low and extremely high temperatures, for example in liquid nitrogen or liquid oxygen, or inside a flame. With room temperature compensation. The immersible NiCr-Ni sensors (P-1002804 and P-1002805) can also be connected to the sensor box. Can be used in conjunction with a 3B NET/log™ unit (P-1000540 or P-1000539) for manual measurements or for processing measurement data when connected to a computer. Includes connector lead with 8-pin miniDIN plugs.

Measurement range: -270°C to 400°C

Accuracy: 0.2% plus 3°C (-270°C – 0°C)

0.1% plus 2°C (0°C – 400°C)

Resolution: 1°C

Sensor type: NiCr-Ni (type K)

Sensor length: 60 cm approx.

P-1000551



P-1000567



P-1000551

Magnetic Field Sensor ±100 mT

Sensor for the measurement of magnetic flux density in the tangential direction. Can be used in conjunction with 3B NET/log™ unit (P-1000540 or P-1000539) for manual measurements or for processing measurement data when connected to a computer. Includes connector lead with 8-pin miniDIN plugs.

Measurement

ranges: 0 – ±2 mT,

0 – ±20 mT,

0 – ±100 mT

Resolution: 0.01 mT, 0.1 mT,

1 mT

Accuracy: ±1.5%

Sensor type: Linearised Hall sensor

P-1000558

Magnetic Field Sensor ±2000 mT

Sensor for the measurement of magnetic flux density in the tangential direction. Can be used in conjunction with 3B NET/log™ unit (P-1000540 or P-1000539) for manual measurements or for processing measurement data when connected to a computer. Includes connector lead with 8-pin miniDIN plugs.

Measurement

ranges: 0 – ±200 mT,

0 – ±2000 mT

Resolution: 0.1 mT, 1 mT

Accuracy: ±1.5%

Sensor type: Linearised Hall sensor

P-1009941



P-1009941



P-1000550

P-1009922

Temperature Sensor, Pt100

Temperature sensor for the measurement of temperatures in organic liquids, solutions of salts, acids, and bases. The stem and tip of the temperature sensor are of stainless steel. Can be used in conjunction with 3B NET/log™ unit (P-1000540 or P-1000539) for manual measurements or for processing measurement data when connected to a computer. Includes connector lead with 8-pin miniDIN plugs.

Measurement

range: -50°C – 150°C

Resolution: 0.1°C

Accuracy: 0.1% of measured

value plus 0.25°C

Sensor cable: 1 m, with silicone insulation

Sensor type: Pt100 thermocouple

P-1000550

Temperature Sensor, Pt100 with Measurement Terminal

Temperature sensor for the measurement of temperatures on the copper tubing of a heat pump (P-1000820/P-1000819). Temperature sensor shaft made of rust-proof stainless steel. Tip with matching copper terminal. Can be used in conjunction with 3B NET/log™ unit (P-1000540 or P-1000539) for manual measurements or for processing measurement data when connected to a computer. Includes connector lead with 8-pin miniDIN plugs.

Measurement

range: -50°C – 150°C

Resolution: 0.1°C

Accuracy: 0.1% of measured

value plus 0.25°C

Sensor cable: 1 m, with silicone insulation

Sensor type: Pt100 thermocouple

P-1009922

P-1000545

High Current Sensor, 10 A

Sensor for the measurement of high electric currents in DC and AC circuits using a shunt resistor. Capable of withstanding loads up to 20 A for short periods. Can be used in conjunction with a 3B NET/log™ unit (P-1000540 or P-1000539) for manual measurements or for processing measurement data when connected to a computer. Includes connector lead with 8 pin miniDIN plugs.

Measurement range: 0 – ±10 A
 Max. current loading: ±20 A for 15 s
 Accuracy: <1%
 Sensor type: Shunt resistor,
 5 mΩ/2 W

P-1000545
Humidity Sensor

Sensor for the measurement of relative humidity (RH). Suitable for weather studies and for monitoring conditions in a greenhouse or terrarium. Can be used in conjunction with a 3B NET/log™ unit (P-1000540 or P-1000539) for manual measurements or for processing measurement data when connected to a computer. Includes connector lead with 8-pin miniDIN plugs.

Measurement range: 0 – 95%
 (non condensing)
 Sensor type: Capacitive sensor
 Accuracy: 3% of RH plus 1% in the range from 0% – 95%
 5% of RH plus 1% in the range from 0% – 5%
 Resolution: 0.1%
 Response time: 15 s

P-1000554
Absolute Pressure Sensor, 2500 hPa

Sensor for the measurement of absolute pressure, e.g. in experiments on the Boyle-Mariotte law. Can also be used for measuring the production of O₂ during photosynthesis and for experiments on transpiration in closed systems. Can be used in conjunction with a 3B NET/log™ unit (P-1000540 or P-1000539) for manual measurements or for processing measurement data when connected to a computer. Includes plastic syringe, silicone tube, and connector lead with 8-pin miniDIN plugs.

Measurement range: 0 – 2500 hPa
 Accuracy: ±1%
 Resolution: 1 hPa
 Sensor type: Semiconductor sensor
 Hose nipple: 4 mm diam.
 Plastic syringe: 20 ml
 Silicone tube: 1 m

P-1000546

P-1000546



P-1000554

Electrometer Box

Impedance converter with high input resistance for the measurement of very small charges and currents. Can be used in conjunction with a 3B NET/log™ unit (P-1000540 or P-1000539) for manual measurements or for processing measurement data when connected to a computer. Includes connector lead with 8-pin miniDIN plugs.

Input resistance: ≥ 10¹¹ Ω
 Measurement error: ≤ 1.5%
 Connectors: 4 mm sockets

P-1000569
Relative Pressure Sensor, ±100 hPa

Sensor for the measurement of relative pressure, e.g. the hydrostatic pressure in a column of water or the pressure difference in a Stirling engine D (P-1000817). Can be used in conjunction with a 3B NET/log™ unit (P-1000540 or P-1000539) for manual measurements or for processing measurement data when connected to a computer. Includes silicone tube and connector lead with 8-pin miniDIN plugs.

Measurement range: 0 – ±100 hPa
 Accuracy: ±1%
 Sensor type: Semiconductor
 Hose nipple: 4 mm diam.
 Silicone tube: 1 m

P-1000547

P-1000548

P-1000569



P-1000549

Barometer

Sensor for the measurement of atmospheric pressure. Can be used in conjunction with a 3B NET/log™ unit (P-1000540 or P-1000539) for manual measurements or for processing measurement data when connected to a computer. Includes silicone tube and connector lead with 8-pin miniDIN plugs.

Measurement range: 700 hPa – 1200 hPa
 Resolution: 0.1 hPa
 Accuracy: 1.5% of the maximum value of the measuring range
 Sensor type: Semiconductor sensor

P-1000549
Relative Pressure Sensor, ±1000 hPa

Sensor for the measurement of relative pressure, e.g. the pressure difference in the Stirling motor G (P-1002594). Can be used in conjunction with 3B NET/log™ unit (P-1000540 or P-1000539) for manual measurements or for processing measurement data when connected to a computer. Includes silicone tube and connector lead with 8-pin miniDIN plugs.

Measurement range: 0 – ±1000 hPa
 Accuracy: ±1%
 Sensor type: Semiconductor
 Hose nipple: 4 mm diam.
 Silicone tube: 1 m

P-1000548

P-1000547

P-1000579

**Important note:**

Our sensors for use with the 3B NET/log™ system are exclusively intended for educational purposes. No measurements obtained with them may be used for diagnosing the health of any individual.

ECG/EMG Box

Sensor box for reading electrocardiograms (ECGs) and electromyograms (EMGs) on skeletal musculature in three standard leads as defined by Einthoven. Feeds can be selected at the press of a button and are indicated by LEDs. For use in conjunction with a 3B NET/log™ unit (P-1000540 or P-1000539) for manual measurements or for computer-linked measurements. A connecting lead with 8-pin miniDIN plugs is included.

Input resistance: > 10 MΩ
Output voltage: max. ±1 V
Blocked frequency: 50 – 60 Hz

P-1000579

Set of 30 Electrodes for ECG/EMG

Set of 30 electrodes for ECG/EMG box for single use.

P-5006578



P-5006578

Light Sensor

Light sensor for the measurement of luminous intensity. Can be used in conjunction with a 3B NET/log™ unit (P-1000540 or P-1000539) for manual measurements or for processing measurement data when connected to a computer. Includes connector lead with 8 pin miniDIN plugs.

Measurement ranges: 0 – 600 lux, 0 – 6000 lux, 0 – 150,000 lux
Resolution: 0.8 lux, 8 lux, 200 lux

P-1000562

Skin Resistance Box

Sensor for measuring the resistance of a person's skin as influenced by external factors (stress, "lie detection"). Designed to conform to the latest safety requirements. Can be used in conjunction with a 3B NET/log™ unit (P-1000540 or P-1000539) for manual measurements or for processing measurement data when connected to a computer. Includes connector lead with 8 pin miniDIN plugs.

Measurement range: 1 MΩ – 10 MΩ
Input resistance: >100 kΩ
Safety category: Safety class II, classification BF

P-1000576



P-1000576

P-1000562

P-1000575

**Human Pulse Sensor Box**

Sensor for measuring frequency of the human pulse at an earlobe or fingertip using an infra-red signal transmitter clip. Automatic adjustment of signal level. Designed to conform to the latest safety requirements. Can be used in conjunction with a 3B NET/log™ unit (P-1000540 or P-1000539) for processing measurement data when connected to a computer. Includes connector lead with 8 pin miniDIN plugs.

Measurement range: Pulse rates from 40 – 160 beats/min
Safety category: Safety class II, classification BF

P-1000575

Set of 3 Conductivity Standards

Set of 3 conductivity standards with conductivities 147, 1413 and 12880 $\mu\text{S}/\text{cm}$, each with a volume of 0.5 l.

P-1000552

Buffer Solution

Set of buffer solutions in three flasks with pH values of 4.00, 7.00 and 9.00.

Volume: 250 ml each

P-1002753

Quinhydrone Buffer Solution (not shown)

Ready-to-use buffer solution with a pH of 7.00 for use with redox sensor.

Volume: 250 ml per container

P-1002754

pH-Sensor

Sensor for the measurement of pH values and redox potentials in aqueous solutions. Can be used in conjunction with a 3B NET/og™ unit (P-1000540 or P-1000539) for manual measurements or for processing measurement data when connected to a computer. Includes connector lead with 8 pin miniDIN plugs.

Measurement range: pH 0 – 14

Sensor type: Ag-AgCl combination electrode, gel filled, not refillable

Accuracy: pH 0.05 in range from 20°C – 25°C

Resolution: pH 0.01

Response time: ≤ 1 s to reach 95% of final value

P-1000556

Additionally recommended:

P-1002753 Buffer Solution

P-1002753

P-1000552



Sensors

Determination of the pH value of an aqueous solution

Titration of acetic acid solution with sodium hydroxide solution

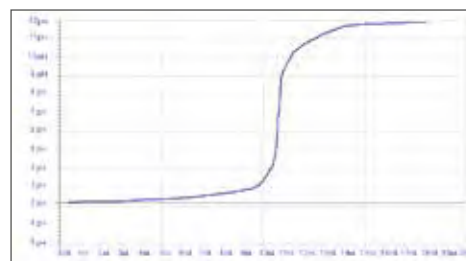

Conductivity Sensor

Sensor for measuring the specific electrical conductivity of liquid media, the total concentration of dissolved substances and the diffusion of ions through membranes, and for showing the difference in conductivity between ionic and molecular compounds and between strong and weak acids. The accessories supplied include a calibrating solution. Can be used in conjunction with a 3B NET/og™ unit (P-1000540 or P-1000539) for manual measurements or for processing measurement data when connected to a computer. Includes connector lead with 8-pin miniDIN plugs.

Measurement ranges: 0 – 200 μS , 0 – 2 mS, 0 – 20 mS

Resolution: 1 μS , 10 μS , 100 μS

Sensor type: measurement electrode using four wire technology, with graphite cells and integrated Pt100 temperature sensor

Accuracy: 5% without calibration, 0.5% with calibration

Sensor cable: 1.5 m

P-1000553



P-1000556



P-1000553

Computer Aided Experimentation



P-1000543
P-1000542



P-1000571



P-1000570

3B POWERlog

Programmable voltage and current source with power output for connection to the two analogue outputs of the 3B NETlog™ unit (P-1000540 or P-1000539). Includes plug in power supply and two connector leads with 8 pin miniDIN plugs.

Output power: 6 W
Current: 0 – ±1 A
Voltage: 0 – ±10 V
Bandwidth: 0 – 50 kHz

3B POWERlog (230 V, 50/60 Hz)

P-1000543

3B POWERlog (115 V, 50/60 Hz)

P-1000542

Additionally required:

P-1000544 3B NETlab™

P-1000540 3B NETlog™ (230 V, 50/60 Hz)

or

P-1000539 3B NETlog™ (115 V, 50/60 Hz)

or

P-1000009 3B NETlog™ with Ethernet Port (230 V, 50/60 Hz)

or

P-1000541 3B NETlog™ with Ethernet Port (115 V, 50/60 Hz)

Relay

Power relay with a set of change over contacts for initiating measurements using 3B NETlab™ software. The relay is controlled by the digital output of the 3B NETlog™ unit (P-1000540 or P-1000539) and it features both normally open and normally closed contacts. Safe potential separation between coil and contact set in accordance with VDE 0160. The contacts are made of a high performance silver alloy. Includes connector lead with 8-pin miniDIN plugs.

Max. switched voltage: 250 V AC / 220 V DC

Max. switched current: 6 A AC / 0.12 A DC

Max. switched power: 1500 VA

Min. switched power: 1 mW

Connectors: 4 mm safety sockets

P-1000566

Additionally required:

P-1000544 3B NETlab™

P-1000540 3B NETlog™ (230 V, 50/60 Hz)

or

P-1000539 3B NETlog™ (115 V, 50/60 Hz)

or

P-1000009 3B NETlog™ with Ethernet Port (230 V, 50/60 Hz)

or

P-1000541 3B NETlog™ with Ethernet Port (115 V, 50/60 Hz)



P-1000566



P-1000555

Digital Output Box

Output box for connecting the digital outputs A, B, C and D of the 3B NETlog™ unit (P-1000540 or P-1000539) to four pairs of 4 mm safety sockets. Includes connector lead with 8-pin miniDIN plugs.

Output signal: TTL level
Connectors: 4 mm safety sockets

P-1000570

Digital Input Box

Input box for connecting the digital inputs A, B, C and D of the 3B NETlog™ unit (P-1000540 or P-1000539) to four miniDIN8 sockets. Includes connector lead with 8 pin miniDIN plugs.

Input and output signal: TTL level
Connectors: 8-pin miniDIN sockets

P-1000571

Redox Sensor

Sensor for measuring redox potentials in aqueous solutions. For use in conjunction with 3B NETlog™ unit (P-1000540 or P-1000539) for manual measurements or measurement acquisition via computer. Includes connector lead with 8-pin miniDIN plugs.

Measuring range: -450 mV to +1100 mV

Sensor type: Ag/AgCl combined electrode filled with gel, non-refillable

Precision: ±4.5 mV in a temperature range from 20°C to 25°C

Resolution: 0.9 mV

Response time: ≤ 1 s for 95% of final value

P-1000555

Additionally recommended:

P-1002754 Quinhydrone Buffer Solution

SW Sensors Set

Set incorporating two dynamometers and an amplifier board for recording and analysing mechanical oscillations using a standard oscilloscope. The dynamometers can be fitted to 10-mm diameter stands or the SW tie bar in order to measure dynamic forces along their axes. The amplifier board converts signals from both dynamometers so that they can be recorded and also evaluates the phase differences between both oscillation signals, outputting them as a DC signal. If the MEC amplifier board is connected to the 2 x 50 MHz USB oscilloscope (P-1017264), it is possible to perform detailed analysis and evaluation of measured signals using the oscilloscope software on a PC.

Dynamometers:

- Maximum force: 5 N
- Frequency range: 0.3 – 200 Hz
- Connectors: 3.5-mm jack plugs
- Dimensions: 52x37x26 mm³

MEC amplifier board:

- Input sockets: 3.5-mm jack sockets
- Output sockets: BNC
- Dimensions: 65x100x40 mm³

Contents:

- 2 Dynamometers
- 1 MEC amplifier board
- 1 Power supply, 12 V AC, 700 mA
- 2 HF Patch cords

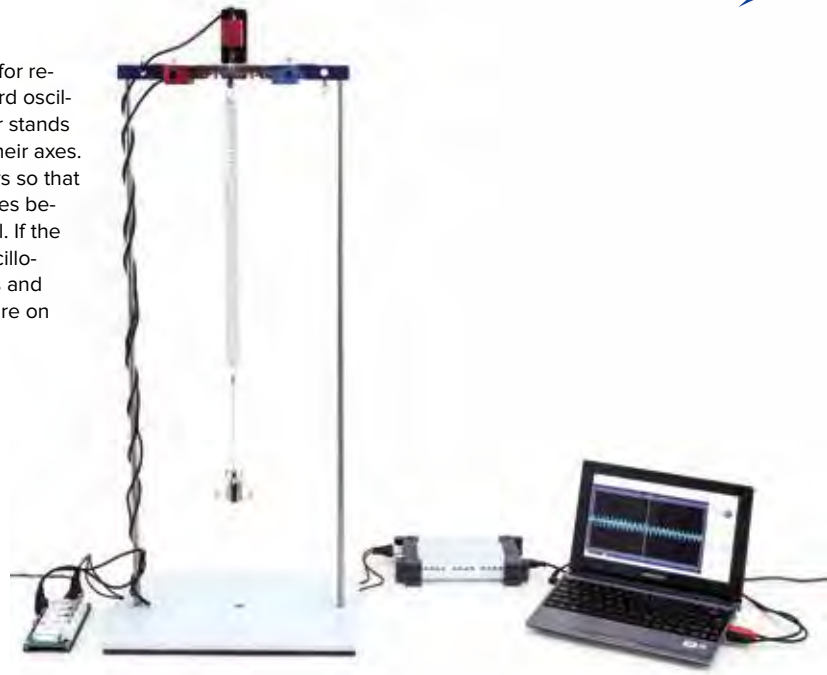

Wilberforce pendulum

SW Sensors Set (230 V, 50/60 Hz)

P-1012850

SW Sensors Set (115 V, 50/60 Hz)

P-1012851

Additionally recommended:

P-1017264 USB Oscilloscope 2x50 MHz

or

P-1008695 Analogue Oscilloscope 2x20 MHz



P-1012850
P-1012851

Software for Fourier Analysis

Software for Fourier analysis and synthesis with depiction of waveform and amplitude spectrum. Analysis of audio signals recorded using a microphone and sound card. Synthesis of Fourier components with an arbitrary choice of fundamental frequency for periodic signals. Signals can be listened to on audio. System requirements: Windows XP or higher, 512 MB RAM or higher, 128 MB graphics card or higher, 16 bit sound card or higher, microphone and speaker.

P-1012587

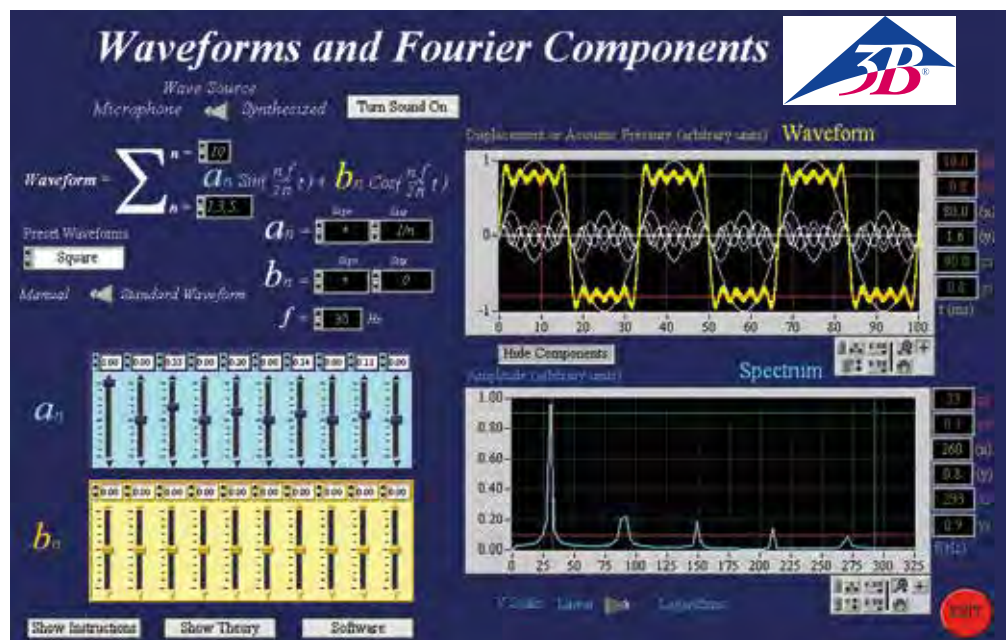

P-1012587

Experiment Topics:

- Inclined plane
- Lever laws
- Torques and forces
- Forces acting on a lever arm
- Force as a vector
- Pendulum motion
- Physical pendulum
- Fixed and movable pulleys
- Block and tackle
- Hooke's law
- Coupled resonance
- Centre of gravity
- Friction

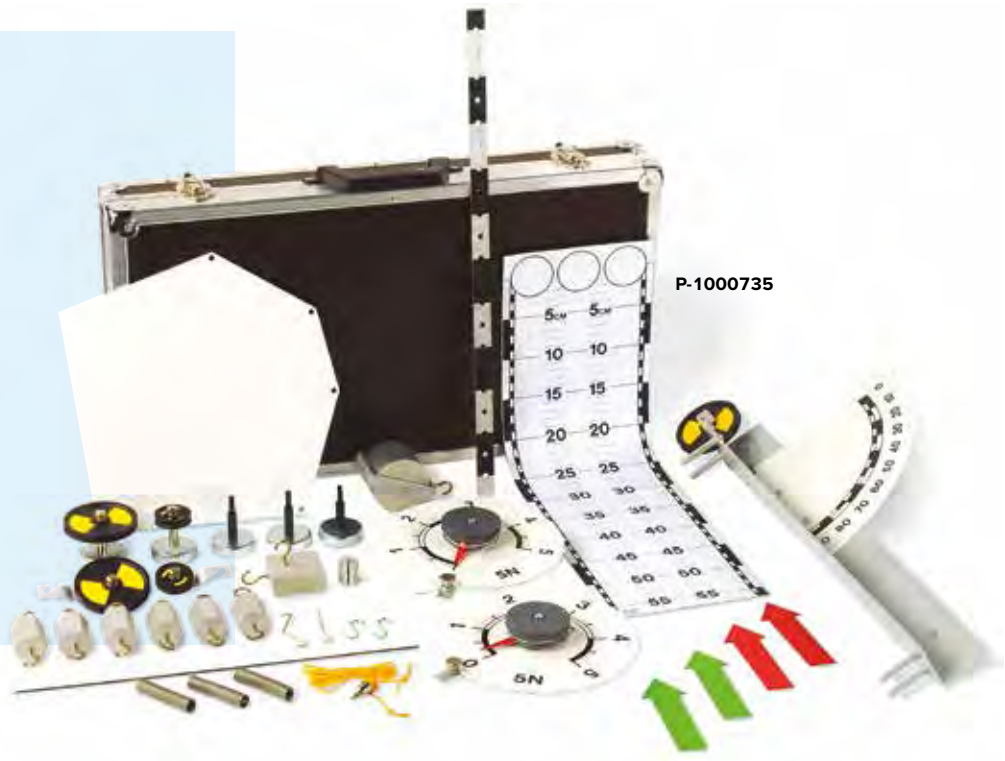

P-1000735

Advantages

- Large components ensure that experiments can be viewed from a distance
- Secure attachment is guaranteed by high-grade AlNiCo magnets
- Quick and easy configuration of experiments
- Measuring units, vector diagrams and explanations can be provided right next to the experimental configuration on the blackboard

Contents:

- 1 Inclined plane with pulley and angle scale
- 1 Rolling mass, 500 g
- 1 Lever with 20 holes, 545 mm long
- 1 Pointer for lever, 400 mm long
- 1 Slotted counterweight with knurled screw, approx. 20 g
- 1 Pulley, double, 70 mm diam., 40 mm diam.
- 1 Pulley, 70 mm diam.
- 1 Pulley, 40 mm diam.
- 2 Round scale dynamometers, 5 N
- 3 Magnetic tabs with 8 mm axis
- 3 Springs with hook, $k = 6.2 \text{ N/m}$
- 1 Dual scale on a magnetic foil, $600 \times 180 \text{ mm}^2$
- 4 Arrows and one equilateral triangle on a magnetic foil
- 6 Weights with 2 hooks, 100 g each
- 1 Friction block
- 1 Set of nylon cords
- 1 Centre-of-gravity plate
- 1 Plumb
- 3 Rubber grommets
- 3 Brass hook
- 1 Brass clip
- 1 Storage case
- 1 Manual

Mechanics Kit for Whiteboard

The mechanics kit for whiteboard demonstrations includes more than 25 large, coloured and easily distinguished components stored in a case with foam inlay. More than 30 experiments can be set up in rapid time.

P-1000735

Additionally recommended:

P-1002591 Whiteboard, $600 \times 900 \text{ mm}^2$

or

P-1002592 Whiteboard, $900 \times 1200 \text{ mm}^2$

P-1002592

P-1002591

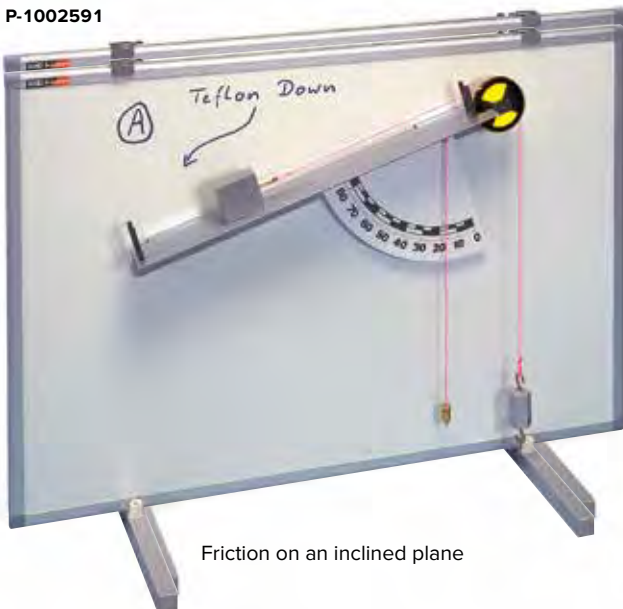

Friction on an inclined plane

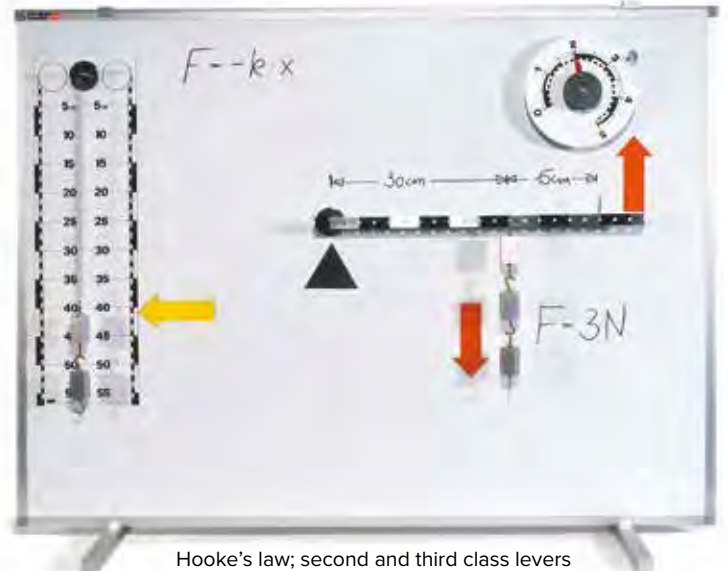

Hooke's law; second and third class levers

Mechanical Cumulative Stopwatch

Cumulative stopwatch with start, stop and reset buttons in shock-resistant plastic casing. Dual dial for minutes and seconds. With pendant cord.
 Measuring range: 15 min
 Scale accuracy: $\frac{1}{10}$ s
 Diameter: 55 mm

P-1002810



P-1002810

Mechanical Stopwatches

Stopwatch in stainless steel casing with dual dial for minutes and seconds. In pouch with pendant cord.

Art. No.	Measuring range	Reading accuracy	Diameter
P-1003368	30 min	0.2 sec	45 mm
P-1003369	15 min	0.1 sec	45 mm

Digital Stopwatch

Stopwatch with 7-digit LCD display in robust plastic casing with start/stop and split/reset buttons for starting and stopping, cumulative, lap-time and dual-time measurement. Includes pendant cord.
 Measuring range: 9 h, 59 min, 59 s, $\frac{99}{100}$ s
 Accuracy: $\frac{1}{100}$ s
 Battery: button cell 1.55 V, Type 389
 Dimensions: approx. 65x65x18 mm³

P-1002811



P-1002811



P-1003369

P-1003368

Timer

Stopwatch for counting up or down with acoustic alarm. Magnetic holder for attachment to metal surfaces and fold-away support legs.
 Display: 4-digit LCD, 18 mm
 Timer range: 99 min 59 s
 Ticking rate: 1 s
 Dimensions: ca. 60x60x20 mm³

P-1003009



P-1003009



P-1002809

Table-Top Stop-Clock

Large quartz-controlled stop-clock with start stop and reset buttons, cumulative time and lap-time settings (clock resets to zero and starts timing again immediately). 2 hands, dial with dual scale for minutes/seconds and hundredths of a minute.
 Measuring range: 60 min / 60 s
 Graduations: 1 s / $\frac{1}{100}$ min
 Dial: 110 mm diam.
 Dimensions: approx. 175x130x95 mm³

P-1002809

Digital Timer

We recommend the use of the digital timer (P-1001033 or P-1001032) along with one or two photo gates (P-1000563) for reliable measurement of the time a carriage on a track takes to cover a distance or when it obscures the light sensors. Also suitable for measuring oscillation periods of a swinging pendulum or similarly the times when it obscures the sensors. As an alternative to a light barrier, a laser reflection sensor (P-1001034) can also be used for the opto-electronic sampling of light and dark markings on moving objects or can be used as a long-distance light barrier when connected in conjunction with reflective foil.

Digital Timer (230 V, 50/60 Hz)

P-1001033

or Digital Timer (115 V, 50/60 Hz)

P-1001032

Photo Gate

P-1000563

or Laser Reflection Sensor

P-1001034

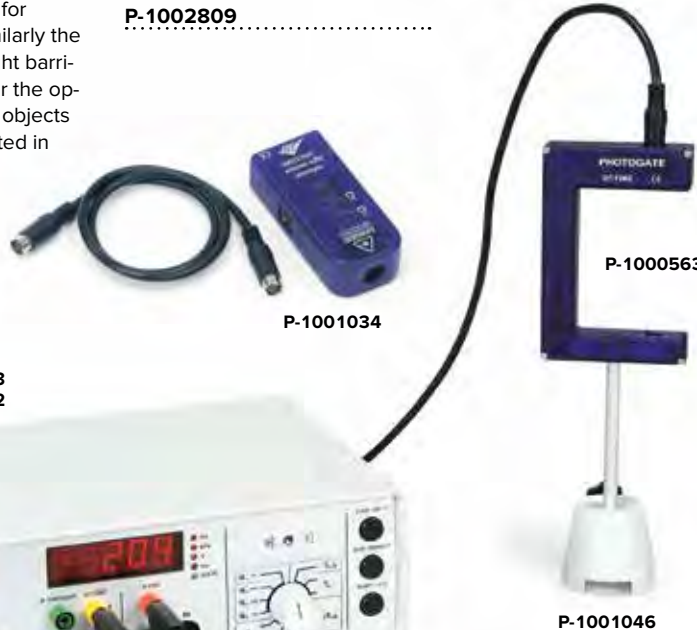

P-1001033
P-1001032

P-1001034

P-1000563

P-1001046

For measuring times when, e.g. a swinging pendulum obscures a sensor

Vertical Ruler, 1 m

Ruler with fastening pin (d = 12 mm) so that it can be set up vertically in a stand base. Scale as per P-1000742.

P-1000743

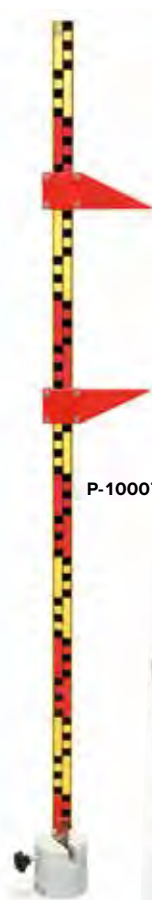

P-1006494

P-1000743

P-1001045

Pocket Measuring Tape, 2 m

Made of spring band steel, with locking button and rewinding spring.

Length: 2 m / 79 inch
Scales: cm, mm / 1/32 inch

P-1002603



P-1002603

P-1000742



Ruler, 1 m

Wooden ruler with mm scale on one side and two-coloured cm scale on the reverse. Cross section: 25x8 mm²

P-1000742

Callipers S

Inexpensive callipers with 125 mm scale suitable for measuring internal and external dimensions and depths.

P-1010217



P-1010217

Set of Riders for Rulers

The set of riders consists of two red plastic pointers to match rulers P-1000742 and P-1000743 that can be used as movable cursors.

Dimensions: 120x40x20 mm³

P-1006494

Digital Callipers, 150 mm

For measuring internal and external dimensions and depth. Tempered stainless steel, LCD display. Including locking screw, adjustment from cm to inch, zero-calibration in any position, with plastic pouch.

Measuring range: 150 mm / 6 inch

Graduation: 0.01 mm / 1/128 inch

Display: 5-digit LCD, 6 mm

P-1002602



P-1002602



UE1010200
PDF online



P-1002600

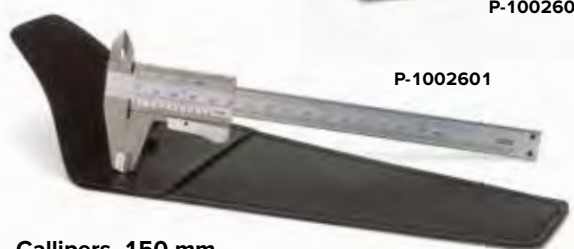

P-1002601

External Micrometer

Precision micrometer with thimble and locking system. Measuring surfaces coated with hardened metal, polished with fine lapping. Tempered measuring spindle with polished thread, chromed micrometer arc with insulation, scale drum and sleeve in matt-chrome finish. In plastic pouch.

Measuring range: 0 – 25 mm

Graduation: 0.01 mm

P-1002600

Callipers, 150 mm

Precision callipers for measuring internal and external dimensions and depth. Tempered stainless steel, precision polished measuring surfaces, gauge with matt-chrome finish. In imitation leather pouch.

Measuring range: 150 mm / 6 inch

Graduation: 1/20 mm / 1/128 inch

P-1002601

Precision Spherometer

For measuring plate thicknesses, depressions and radii of curvature of spherical surfaces, for example, lenses. The device consists of a tripod with three steel tips which form an equilateral triangle. A micrometer screw with a measuring tip is recessed in the middle. Attached to the micrometer screw is a disc with circular divisions from 0 to 500 and a vertical scale with millimeter divisions from -10 to 15 mm at the tripod.

Measuring ranges: 0 – 25 mm and -10 – 15 mm

Screw pitch: 0.5 mm

Measuring accuracy: 0.001 mm

Support spacing: 50 mm

P-1002947

Additionally recommended:

P-1003190 Plane Mirror

P-1002947

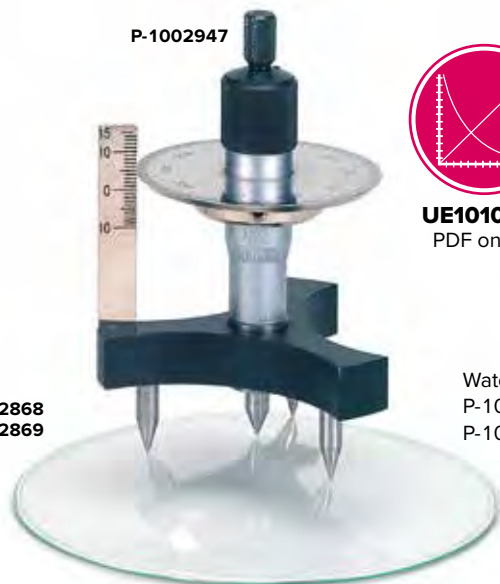

P-1002868
P-1002869



UE1010100
PDF online

Watch Glasses from P-1002868 and P-1002869



Callipers Model
Model of a set of callipers suitable for measuring internal and external dimensions and depths of up to 300 mm.
Dimensions: 420x195 mm²
P-1010214

P-1010214

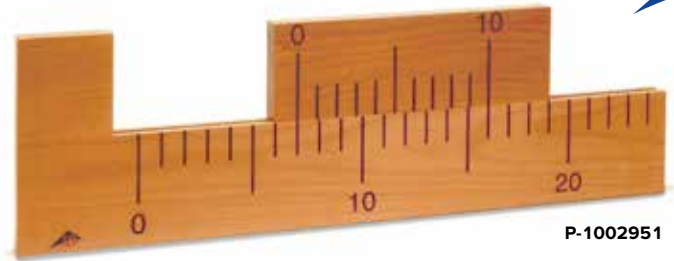

P-1002951

Vernier Model
For demonstrating Vernier readings on length measuring devices and protractors.
Length: 600 mm
Vernier length: 260 mm
Height: 190 mm

P-1002951

Wooden Rulers
These wooden rulers are a classroom staple.

Wooden Ruler, 1 m, Set of 10

P-1003233

Wooden Ruler, 0.5 m, Set of 10

P-1003234



P-1003233

P-1003234

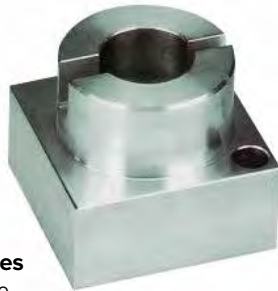

P-1006889

Object for Measurement Exercises
Irregularly shaped body, which is especially well suited for practising measurement using Vernier callipers.

P-1006889



P-1009713

Vessel with Overflow, metal
Vessel with overflow, 900 ml, made of metal.

P-1009713



P-1003518

Vessel with Overflow, Transparent
Vessel with overflow, 275 ml, made of Plexiglas.

P-1003518

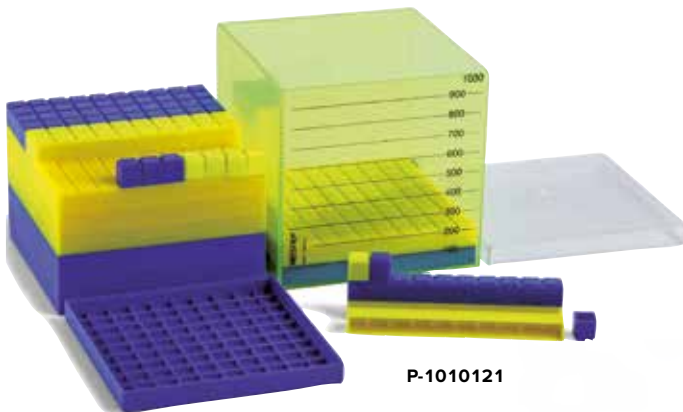

P-1010121

Broken Down Cubic Decimetre
Transparent and graduated cube of 100x100x100 mm³ with contents:
9 cuboids, 100 cm³ (4 yellows and 5 blues)
9 cuboids, 10 cm³ (4 yellows and 5 blues)
10 cubes, 1 cm³ (5 yellows and 5 blues)

P-1010121

Set of 1-Litre Bodies
Set of equipment consisting of 5 transparent hollow bodies with engraved volume scale.

- Cylinder, 1 l 100 mm (diam.) x 120 mm approx.
- Cylinder, 0.5 l 75 mm (diam.) x 115 mm approx.
- Cylinder, 1 l 160 mm (diam.) x 50 mm approx.
- Cube, 1 l 100x100x100 mm³ approx.
- Cuboid, 1 l 200x100x50 mm³ approx.

P-1012882



P-1012882



P-1003102 – P-1003110

Advantages

- Precision
- Easy to read
- Colour coding

Precision Dynamometer

Colour coded precision dynamometer in a transparent plastic casing with easy-to-read scale, protection against over extension of the spring and zero-point calibration capability.

Precision: < 1% of total measuring range
 Scale division: 1% of total measuring range
 Dimensions: 280 mm x 16 mm diam.

Art. No.	Colour	Measuring range
P-1003102	Silver	0.1 N
P-1003103	Beige	0.2 N
P-1003104	Yellow	1 N
P-1003105	Red	2 N
P-1003106	Blue	5 N
P-1003107	Green	10 N
P-1003108	Violet	20 N
P-1003110	Brown	100 N



P-1002698 – P-1002701

Dynamometer, Transparent

Dynamometer with easily read scale printed on a transparent plastic sleeve. Suitable for projection using a projector. With protection against over extension of the spring.

Precision: $\pm 3\%$ of total measuring range
 Length: 185 mm
 Scale length: 60 mm

Art. No.	Measuring Range	Scale Division
P-1002698	1 N	0.02 N
P-1002699	2 N	0.04 N
P-1002700	5 N	0.1 N
P-1002701	10 N	0.2 N

Dynamometer, Colour Coded

Colour coded dynamometer for measuring weights or masses as well as forces. Scaled in newtons or grams and kilograms with zero-point calibration.

Art. No.	Colour	Measuring Range	Scale Division
P-1003370	Blue	250 g / 2.5 N	5 g / 0.05 N
P-1003371	Green	500 g / 5 N	10 g / 0.1 N
P-1003372	Brown	1000 g / 10 N	20 g / 0.2 N
P-1003373	Red	2000 g / 20 N	50 g / 0.5 N
P-1003374	White	3000 g / 30 N	50 g / 0.5 N
P-1003375	Yellow	5000 g / 50 N	100 g / 1 N



P-1003370 – P-1003375

Dynamometer with Round Dial

Spring dynamometer for experiment demonstrations. Grooved pulley on ball bearings and cord with hook. Large, easily read round dial. Zero-point calibration via knurled screw. With magnet for attachment to a whiteboard.

Diameter: 200 mm

Art. No.	Measuring range	Scale Division
P-1009738	1 N	0.02 N
P-1009739	2 N	0.05 N
P-1009740	5 N	0.1 N
P-1009741	10 N	0.1 N



P-1009738



P-1009739



P-1009740



P-1009741

Set of Helical Springs for Hooke's Law

5 helical springs with a hook and an attached pointer for determining spring constants

P-1003376

Spring constant	2.5 N/m	5 N/m	10 N/m	15 N/m	25 N/m
Length	122 mm	145 mm	150 mm	147 mm	142 mm
Diameter	15 mm	15 mm	19 mm	20 mm	20 mm

Additionally recommended:

P-1000773 Set of Slotted Weights 10x 10 g, Red and Grey

P-1000743 Vertical Ruler

P-1006494 Set of Riders for Rulers

Stand equipment

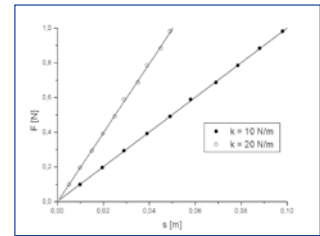
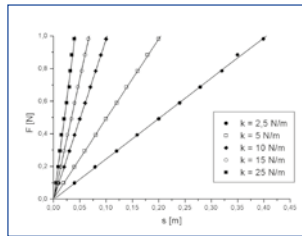

Dynamometers for Demonstrating Hooke's Law

Two colour coded dynamometers in transparent plastic sleeve with easy-to-read cm/mm scale for demonstrating Hooke's law and calculating the spring constant. Protection against over extension of the spring and zero-point calibration.

Spring constants: 10 N/m and 20 N/m

Length of scale: 115 mm

Dimensions: 280 mm x 16 mm Ø

P-1003109

Additionally recommended

P-1003227 Set of Slotted Weights 10 g

P-1000743 Vertical Ruler

Stand equipment



Helical Springs

Helical Springs

For experiments on expansion and oscillation, with two suspension eyelets. Tolerance 10%.

Art. No.	Spring constant	Length	Diameter
P-1000786	1.5 N/m	120 mm	20 mm
P-1003515	2.5 N/m	120 mm	16 mm
P-1002945	3.9 N/m	30 mm	34 mm
P-1000741	5 N/m	60 mm	20 mm
P-1002702	16 N/m	115 mm	6 mm
P-1002703	43 N/m	110 mm	9 mm
P-1002946	20 N/m	180 mm	8 mm
P-1002704	86 N/m	95 mm	10 mm

Mechanics

Set of 10 Weights

Brass weights with hooks on both sides so that they can be suspended from one another.

Set of 10 Weights, 10 g

P-1000770

Set of 10 Weights, 20 g

P-1000769

Set of 10 Weights, 50 g

P-1000771

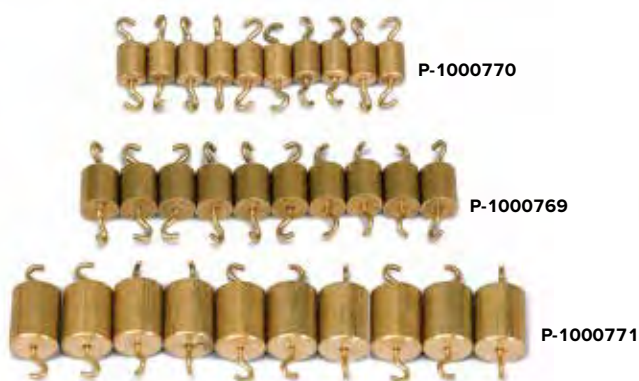

Sets of Slotted Weights on Weight Holder

Slotted brass weights and holder.

Art. No.	Designation	Weights (incl. holder)	Holder diam.
P-1003226	Set of slotted weights, 20 – 100 g	2x 5 g, 1x 10 g, 4x 20 g	22 mm
P-1003227	Set of slotted weights, 10x 10 g	10x 10 g	18 mm
P-1003229	Set of slotted weights, 5x 50 g	5x 50 g	32 mm
P-1003228	Set of slotted weights, 5x 100 g	5x 100 g	38 mm

Set of Slotted Weights on Holder, red and grey

Coloured slotted weights with holder for use in experiment demonstrations.

Art. No.	Designation	Weights (incl. holder)	Holder diam.
P-1000773	Set of slotted weights, 10x 10 g, red and grey	10x 10 g	25 mm
P-1000775	Set of slotted weights, 8x 50 g, red and grey	8x 50 g	25 mm
P-1000777	Set of slotted weights, 4x 100 g, red and grey	4x 100 g	25 mm



Set of Weights 10 g to 1000 g

9-piece set of brass weights in storage box, each with hooks on both sides. 1x 10 g, 2x 20 g, 1x 50 g, 1x 100 g, 2x 200 g, 1x 500 g, 1x 1000 g

P-1003214

Set of Weights 1 g to 50 g

8-piece set of brass weights, delivered in storage box. 1x 1 g, 2x 2 g, 1x 5 g, 2x 10 g, 1x 20 g, 1x 50 g

P-1003210

Set of Weights, 1 g to 1000 g

13-piece set of brass weights in storage block. 1x 1 g, 2x 2 g, 1x 5 g, 1x 10 g, 2x 20 g, 1x 50 g, 1x 100 g, 2x 200 g, 1x 500 g, 1x 1000 g

P-1003212



P-1003214



P-1018597

Set of Weights 1 g to 500 g, slotted with Holder

13-piece set of brass weights on convenient storage rack.

1x 1 g, 2x 2 g, 1x 5 g, 1x 10 g, 2x 20 g, 1x 50 g, 1x 100 g, 2x 200 g, 1x 500 g, holder 50 g

P-1018597

Set of Weights 100 g to 2000 g

7-piece set of weights with hooks. 1x 100 g, 2x 200 g, 1x 500 g, 2x 1000 g, 1x 2000 g

P-101052



P-1001052



P-1003210



P-1003212



P-1010234

Set of Weights 1 mg to 500 mg

Set of 12 aluminium weights in a plastic box. 1x 0.5 g, 1x 0.2 g, 2x 0.1 g, 1x 0.05 g, 2x 0.02 g, 1x 0.01 g, 1x 5 mg, 2x 2 mg, 1x 1 mg.

P-1010234



P-1000676

Set of Three Weight Holders with Slotted Weights

Slotted brass weights on holder comprising 3 sets with 2x 5 g, 2x 10 g, 2x 20 g, 3x 50 g.

P-1000676



P-1010168

Set of Weights with Hooks

11-piece set of weights with hooks on both sides so that they can be suspended from one another. Tolerance: 10%. 1x 1 g, 2x 2 g, 1x 5 g, 2x 10g, 1x 20 g, 1x 50 g, 2x 100 g, 1x 200 g.

P-1010168

Bench Scales, Harvard Junior

Inexpensive and colourful two-pan scales made of plastic. No less stable or accurate than many more expensive scales. With high-precision manufactured metal beam, interchangeable pans and zero adjustment. Includes a set of 8 weights. Built-in interlock to protect against vibration during transport or during long-term storage. Stackable.

Maximum load: 2 kg
 Precision: 0.5 g
 Pans: 150 mm diam., plastic, shallow and high-sided versions

Set of weights: Set of 8, 370 g

P-1012872



P-1012872



Set of Weights 1 g to 500 g

12-piece set of brass weights in storage block. 1x 1 g, 2x 2 g, 1x 5 g, 2x 10 g, 1x 20 g, 1x 50 g, 2x 100 g, 1x 200 g, 1x 500 g.

P-1010189

P-1010189



P-1018834

Beam Balance

Beam balance on hard plastic base plate. Aluminium beam on steel needle bearing with adjustment screws. Removable stainless steel balance pans. Usable also for hydrostatic experiments in connection with metal bridge (P-1018835) and Archimedes cup (P-1018836).

Maximum load: 500 g
 Resolution: 20 mg
 Pans: 120 mm diam.

P-1018834

Additionally recommended:

P-1010189 Set of Weights 1 g to 500 g

P-1010234 Set of Weights 1 mg to 500 mg

Experiment Topics:

- Determining initial equilibrium position of a torsion pendulum
- Recording of damped oscillations around the final equilibrium position of a torsion pendulum over time
- Determining final equilibrium position of a torsion pendulum by final deflection method
- Determination of gravitational constant **G** from the period of oscillation and the difference between the equilibrium positions
- Determination of gravitational constant **G** by acceleration method

Oscillation about the two equilibrium positions



P-1003337



UE1010300
PDF online

Cavendish Torsion Balance

A Cavendish torsion balance demonstrates the force of gravity between two masses and allows the gravitational constant to be determined. Thanks to the short oscillation period of just 2 – 4 minutes, the gravitational constant can be determined within the space of a single lesson with an accuracy of better than 10%. The core of the apparatus is a torsion pendulum made of a light bar with two small lead spheres, which is suspended horizontally from a thin wire. The apparatus is moved from its equilibrium position by the attraction of the two spheres to two larger lead spheres. When the two large spheres are rotated to a new position, the torsion balance will oscillate about a new equilibrium position. The rotary motion is measured using a capacitive differential sensor, which largely suppresses noise and vibration components in the signal. The output is then recorded using a computer. For subsequent evaluation, the data can be exported to a spreadsheet. Alternatively, the motion can be demonstrated with the aid of a light pointer.

Mass of large lead spheres:	1 kg
Mass of small lead spheres:	15 g
Gravitational attraction:	$< 10^{-9}$ N
Torsion wire:	Tungsten, 25 μ m
Period of oscillation:	2 – 4 min
Angular resolution:	25 microradians
Sampling rate:	0.5, 1, 2, 5, 10 samples/s
Dimensions:	190x180x200 mm ³
Weight:	5 kg

Includes:

- 1 Cavendish torsion balance
- 1 Measurement software
- 1 USB cable

P-1003337

Additionally recommended:

P-1003201 Diode Laser, Red 650 nm

Stand equipment

Tungsten Wire (not shown)

Roll of torsion wire for Cavendish torsion balance (P-1003337).
Diameter: 25 μ m

P-1009718

Experiment Topics:

- Day and night
- Seasons
- Phases of the moon
- Solar and lunar eclipses and their cycles

Orbit™ Tellurium

Attractive and easy-to-operate three-dimensional model of the sun, moon and earth, for comprehensive demonstration of their motions. Earth and moon in two different sizes in order to demonstrate day and night, motion of the sun across the sky, annual seasons, the changing amounts of daylight, phases of the moon, as well as solar and lunar eclipses and the cycles they exhibit. Shadows have clear edges since the sun is represented by a bright lamp with a Sunbeam™ reflector. As an alternative to turning the whole system together, the rotation of the earth on its axis and the position of the moon in its orbit can be adjusted individually by hand.
Dimensions: 650x250x300 mm

Includes:

Tellurium with earth and moon in two sizes; display cards showing dates, solar eclipses, lunar eclipses and phases of the moon; small figure; sundial; detailed instructions in English; mains transformer, 100 – 240 V/6V

P-1008661

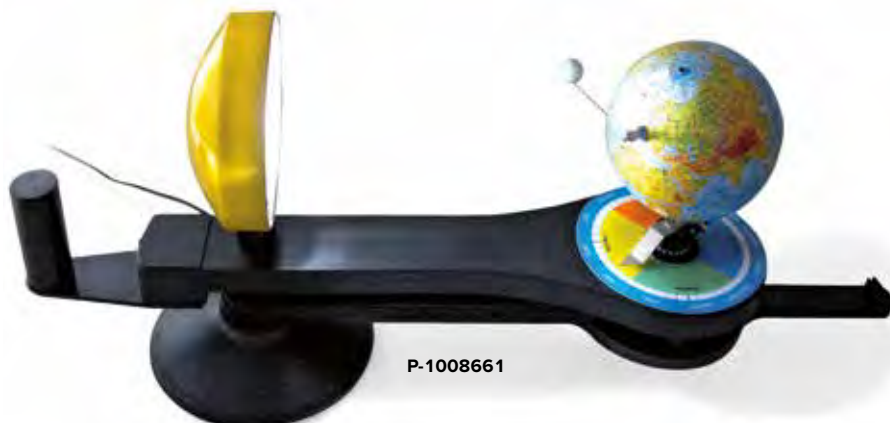

P-1008661

Advantages

- Greater reading accuracy thanks to having two angle scales
- Can be extended to feature four force components

Force Table

Equipment for quantitative investigation of the combination and resolution of forces, consisting of a circular workplate on a stable base with dual protractor scale. Weights from set of three weight holders with slotted weights P-1000676 (included), are suspended from 3 cords strung over pulleys with ball bearings.

Dimensions: approx. 300 mm x 390 mm \varnothing

Weight: approx. 3,1 kg

P-1000694

Additionally recommended:

P-1000699 Extra Pulley



P-1000694

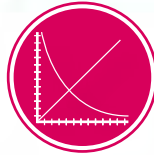

UE1020300
PDF online

Centre-of-Gravity Plate

Plastic plate with 6 boreholes for introducing the concept of centre of gravity and determining centroids.

P-1008513

Additionally required:

P-1002940 Plumb with Line



P-1000699

Extra Pulley

Additional pulley for use with the force table (P-1000694) with clamp, cord and holder with set of slotted weights 2x 5 g, 2x 10 g, 2x 20 g and 3x 50 g.

P-1000699



P-1002604

Universal Spirit Level, 250 mm

Spirit level made of shock resistant plastic for measuring angles to horizontal, vertical and inclined planes and for joinery. With two plexi-glass level gauges, resistant to breakage and leakage. Horizontal gauge built-in and accurately calibrated. Gauge for measuring inclination can be rotated and fixed in place. Scale markings for 45°, 60° and 120°, mm scale on measuring surface, protractor scale for inclination gauge.

Scales: 250 mm/1 mm, -90° – +90°/2°

Dimensions: 250x54x15 mm³

P-1002604

Stability Apparatus

For demonstrating the stability of an object as a function of the position of its centre of gravity above the supporting surface. The position of the centre of gravity can be adjusted by tilting the device. The position of the centre of gravity over the base of the stand is indicated by a built-in plumb bob.

Dimensions: 180x150x290 mm³

P-1002950

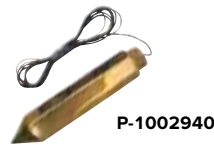

P-1002940

Plumb with Line

Brass body with a line.

Height: 100 mm

Diameter: 20 mm

Weight: 220 g

Line length: 1600 mm

P-1002940

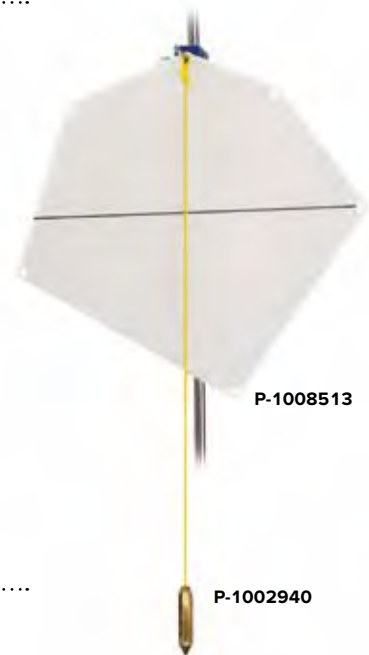

P-1008513

P-1002940



P-1002950

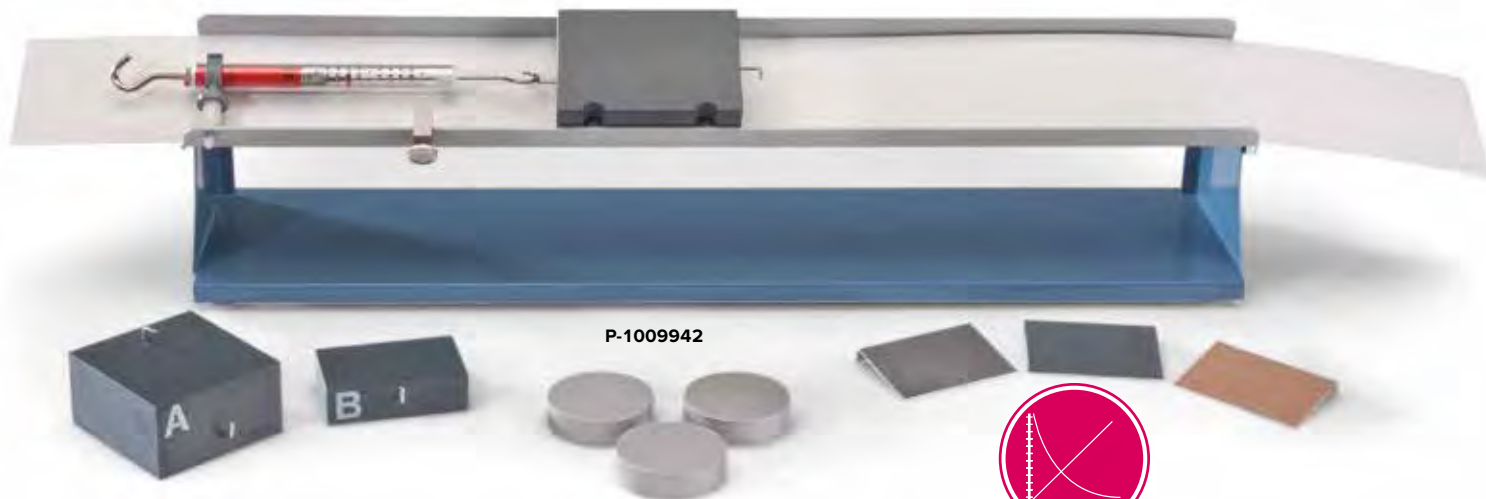

P-1009942

UE5010500
 PDF online

Advantages

- Complete apparatus: additional accessories not required
- Robust, durable

Friction Measuring Apparatus

Demonstration apparatus with movable friction surface for measuring static and dynamic friction between two surfaces as a function of area, force between the surfaces or the combination of materials. For easy measurement of dynamic friction, the movable surface is moved at constant speed under a static body connected to a dynamometer. The friction track can be inclined along its length in order to vary the force between the two surfaces.

Dimensions: 600x140x150 mm³

Weight: 3 kg

Contents:

Basic apparatus with movable friction surface, 2 N dynamometer, three different static bodies, three rails for holding static bodies, three 100 g weights.

P-1009942



P-1003104
 P-1003105
 P-1003107

Precision Dynamometer

Colour coded precision dynamometer in a transparent plastic casing with easy-to-read scale, protection against over extension of the spring and zero-point calibration capability.

Precision: < 1% of total measuring range

Scale division: 1% of total measuring range

Dimensions: 280x16 mm diam.

Block for Friction Experiments

Aluminium block with a teflon-coated surface and 2 hooks.

Dimensions: 55x50x25 mm³

P-4003876

P-4003876



Wooden Blocks for Friction Experiments

Two wooden blocks with plastic coated surfaces and hook for attaching a dynamometer.

Dimensions: approx. 120x60x60 mm³ and 120x60x30 mm³

P-1002944

Additionally recommended:

P-1003104 Precision Dynamometer, 1 N

P-1003105 Precision Dynamometer, 2 N

P-1003107 Precision Dynamometer, 10 N

P-1003212 Set of Weights, 1 g to 1000 g



P-1002944



P-1003224

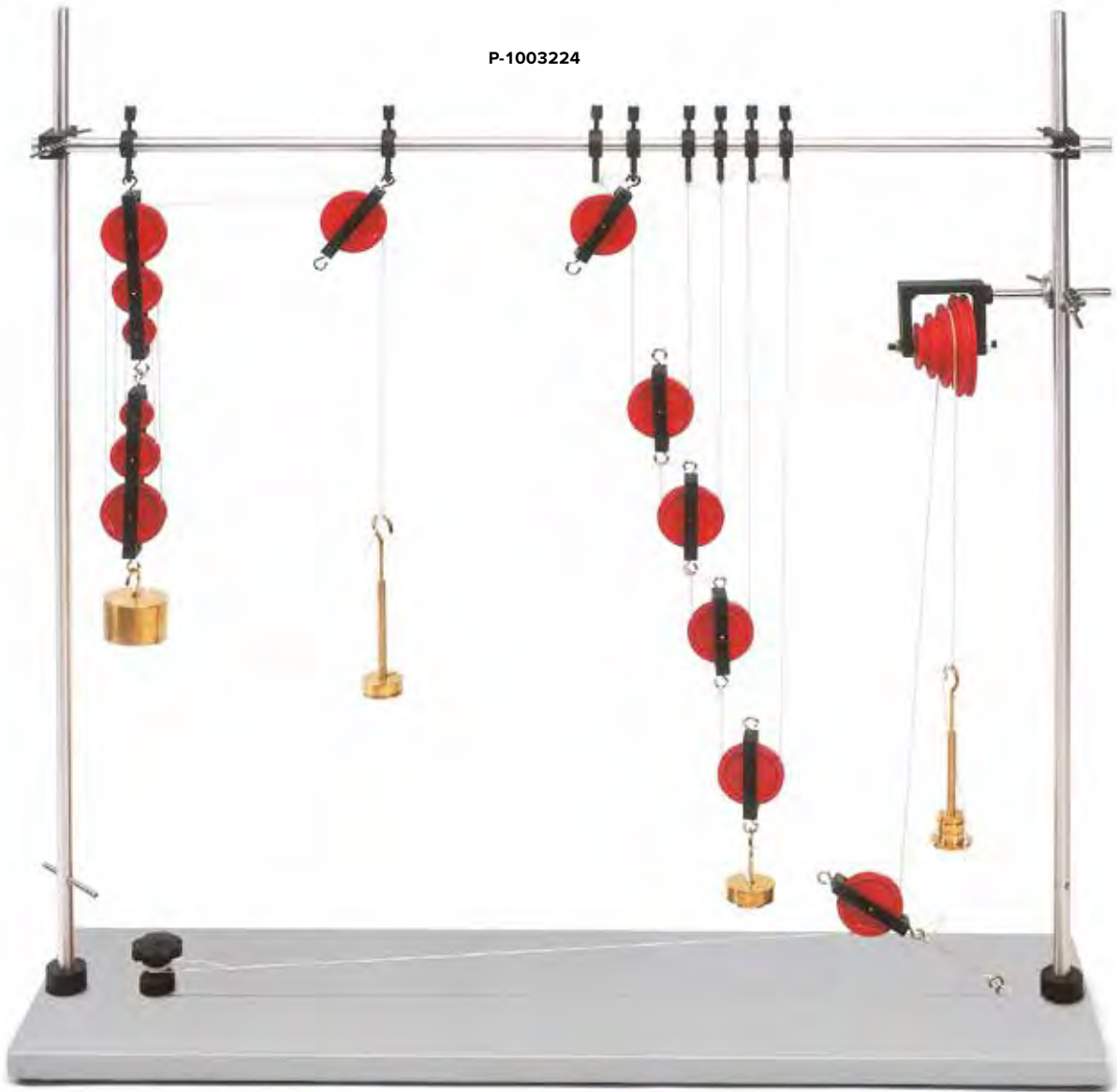

Experiment topics:

- Fixed pulley
- Movable pulley
- Block and tackle
- Wheel on axle

Experiment Set Pulleys and Block and Tackle

For demonstrating how forces can be altered in direction and distributed over an area by simple machines (fixed and movable pulleys, block and tackle) and introducing the concepts of mechanical work, power and energy. Complete set of equipment consisting of a stable base plate, retort stand rods, pulley blocks, block and tackle, a set of pulleys of various diameters on an axle, weight holders, slotted weights and a reel of cord. All the experiments can be set up quickly and easily since the closed plastic frame around the pulleys prevents the cord from slipping.

Base plate: 810x200 mm²
 Pulleys: 50 mm diam.

Stand rods: 810 mm x 12,5 mm diam.
 Slotted weights: 2x 10 g, 2x 20 g, 2x 50 g, 4x 100 g, 4x 200 g, 1x 500 g
 Holders: 1x 10 g, 1x 20 g, 5x 50 g

Contents:

1 Base plate	2 Tandem pulley blocks with 3 pulleys
3 Stand rods	1 Wheel on axle
2 Plastic clamps	15 Slotted weights
1 Universal sleeve	7 Weight holders
8 Hooks	1 Reel of cord
7 Pulley blocks with 1 pulley	1 Screw pin
2 Pulley blocks with 4 pulleys	

P-1003224

Additionally required:

- P-1002603 Measuring Tape, 2 m
- P-1002700 Dynamometer 5 N
- P-1003369 Mechanical Stopwatch, 15 min

Pulley with Table Clamp

Pulley for altering the direction of forces. Plastic pulley with ball bearings and cord groove plus securing clamp. Also has a bore so that it can be attached to a retort stand of up to 12.5 mm diameter.

Pulley: 50 mm diam.
Span of bracket: up to 35 mm span

P-1003221



P-1003221

Pulleys and Block and Tackle

For experiments with fixed and movable pulleys. Non-deformable, low-friction pulleys with cord grooves and hooks at the ends of both axes for suspending from fixed supports or other pulleys. The enclosed design of the plastic frame prevents the cord from slipping off the pulley.

P-1003216



P-1003217

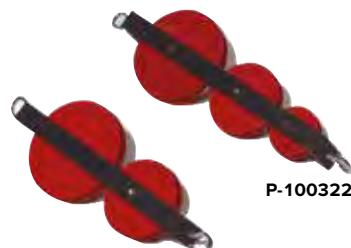

P-1003223

P-1003222

Art. No.	Designation	Pulleys	Diameter	Material
P-1003216	Pulley block	1	50 mm	plastic
P-1003217	Pulley block	2	50 mm	plastic
P-1003218	Pulley block	3	50 mm	plastic
P-1003222	Tandem pulley	2	37/50 mm	aluminium
P-1003223	Tandem pulley	3	25/37/50 mm	aluminium



P-1008539

Lever

Complete set of equipment for demonstrating laws of leverage and for experiments on equilibrium. Consists of a retort stand to which is attached a lever mounted on ball bearings with three rows of holes for adjusting the axis of rotation or for suspending weights, red and white block scale with pointer for accurate display of equilibrium state. Can also be used to model balance scales. Includes set of weights 10x 50 g.

Length of lever: 1 m
Mass of lever: 0.458 kg
Number of holes: 21
Separation of holes: 50 mm

P-1008539

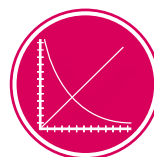

UE1020200
PDF online



Inclined Plane

Equipment for investigating forces acting on a body on an inclined plane, and determining the holding friction as a function of the angle of inclination. Metal base and inclined plane. The plane is hinged with scales for angle, length and height. Angle of inclination can be adjusted between 0 and 45°. Includes adjustable pulley, roller, weight pan and cord.

Length of inclined plane: 600 mm
Length of base: 450 mm
Scales: divided into cm or degrees

P-1003213

Additionally recommended:

P-1002701 Dynamometer, 10 N

P-1010189 Set of Weights 1 g to 500 g



P-1003213



UE1020400
PDF online

Experiment Topics:

- Regular movements and movements with uniform acceleration
- Newton's laws of motion
- Conservation of energy
- Elastic and inelastic collisions



P-1018102



UE1030250
PDF online

Trolley Track

Track with two trolleys and other accessories for investigating linear motion, plus three adjustable point supports for setting horizontal alignment. The trolleys move with minimum friction on wheels with high-quality ball-bearings. They are fitted with magnets at their front ends for experiments involving both elastic and inelastic collisions. Including a spoked wheel suitable for use as a pulley with the trolley track. It can be used in combination with a light barrier (P-1000563) for recording the motion of a trolley.

Mass of trolleys: 500 g
Length of distance scale: 1800 mm
Overall length: 1800 mm

Contents:

- 1 Track, 1.8 m
- 1 Two-point support
- 1 Single point support with end stop
- 1 Trolley
- 1 Trolley with interchangeable buffer pad
- 1 Additional weight, 500 g
- 2 Holder for light barrier
- 1 Holder for pulley
- 1 Pulley
- 1 Clamp for stand rods
- 1 Set of contact-breakers
- 1 Set of magnets

P-1018102

Additionally recommended:

- P-1007112 Cord, 100 m
- P-1003227 Set of Slotted Weights, 10 x 10 g
- P-1000563 Photo Gate
- P-1000540 3B NET/og™ (230 V, 50/60 Hz) or
- P-1000539 3B NET/og™ (115 V, 50/60 Hz)

- P-1007112 Cord, 100 m
- P-1003227 Set of Slotted Weights, 10 x 10 g
- P-1000559 Ultrasonic Motion Sensor



P-1000540 3B NET/og™ (230 V, 50/60 Hz) or
P-1000539 3B NET/og™ (115 V, 50/60 Hz)

P-1007112 Cord, 100 m
P-1003227 Set of Slotted Weights, 10 x 10 g
P-1000563 Photo Gate (2x)
P-1000540 3B NET/og™ (230 V, 50/60 Hz) or
P-1000539 3B NET/og™ (115 V, 50/60 Hz)

Cord, 100 m
100 m length of hemp string,
black, rolled onto bobbin.

P-1007112

P-1007112



Experiment Topics:

- Regular movements and movements with uniform acceleration
- Newton's equations of motion
- Laws on the conservation of momentum and energy
- Elastic and inelastic collisions
- Motion on an inclined air track



Advantages

- Track cannot bend (on stable support with U-shaped profile)
- Length of track 1.9 m
- Sliders move with almost zero friction

Air Track

Track with square profile and 2 gliders for investigating frictionless linear motion. Mounted on a robust U-shaped base resting on three feet that can be adjusted to ensure horizontal alignment. The air is blown in from the front and escapes through small air outlets arranged in 2 rows along the track. This allows for practically frictionless movement of the gliders on the triangular track with no tilting. With millimetre tape measure.

Material:	Anodised aluminium
Total length:	2.00 m
Working length:	1.90 m
Maximum deviation from straight line over complete length:	0.03 mm
Track profile:	Square, 63x63 mm ²
Thickness of walls:	3 mm
Separation of air outlets holes:	20 mm
Base profile:	U-shaped profile
Width of base:	100 mm
Height of base:	50 mm
Wall thickness of base:	5 mm

Contents:

- 1 Air track on U-shaped base profile resting on three feet
- 2 Gliders made of black anodised aluminium with 4-mm holes to accommodate velocity flags and other accessories, plus pins at the sides to hold additional weights, mass: 170 g, length: 125 mm
- 4 Additional 50 g weights
- 1 Velocity flag with plug for interrupting light barriers, mass: 10 g, width: 100 mm
- 2 Velocity flags with plug for interrupting light barriers, mass: 5 g, width: 25 mm
- 3 Forks with plugs and rubber bands for catapulting gliders and investigating elastic collisions, mass: 10 g
- 3 Plates with plugs for investigating elastic collisions, mass: 10 g
- 1 Needle with plug for investigating inelastic collisions, mass: 10 g
- 1 Small tube with plug and plastic filling for investigating inelastic collisions, mass: 10 g
- 1 Hook with plug for attaching a thread with accelerating weights on the end, mass: 10 g
- 1 Pulley for frictionless deflection of accelerated masses
- 1 Set of screws and tools for assembling air track
- 1 Manual

P-1019299

Additionally required:

- P-1000606 Air Flow Generator (230 V, 50/60 Hz)**
or
P-1000605 Air Flow Generator (115 V, 50/60 Hz)

Additionally recommended:

- P-1019300 Electromagnetic Launch Apparatus**
P-1019301 Switch Box
P-1019180 Set of Hook Weights and Thread



P-1000606
P-1000605

Air Flow Generator

Fan allowing continuous adjustment of air flow. Includes a hose.

- Hose length: approx. 1.5 m
- Power consumption: max. 1100 W
- Dimensions: 300x180x170 mm³
- Weight: 4.4 kg

Air Flow Generator (230 V, 50/60 Hz)

P-1000606

Air Flow Generator (115 V, 50/60 Hz)

P-1000605



P-1019301

Switch Box

Control unit which is used in conjunction with the electromagnetic launch apparatus to shut off the current and simultaneously send a signal to a connected counter/timer.

Power supply: 8 V DC

P-1019301

Electromagnetic Launch Apparatus

Used along with a catapult assembled from a fork and rubber band included in the air track set, the launch apparatus imparts uniform, reproducible launch momentum to a glider which is dependent on the tension in the rubber band. It consists of an iron core, a solenoid coil and an armature. The iron core is attached to the end of the air track where it provides a mount for the coil. The glider is connected to the coil via the armature and catapult. When the current is interrupted, the tensed rubber band imparts energy to the glider. A switch box (P-1019301) is used to activate the system.

- Iron core: 20x20x51 mm
- Coil: 400 turns
- Power supply: 8 V DC

P-1019300

Additionally recommended:

P-1019301 Switch Box

Set of Hook Weights and Thread

Set of propulsion weights and thread for acceleration of sliders on air-cushion track. Consisting of 3 S-shaped hooks, 1 g, 5 S-shaped hooks, 2 g, and 1 roll of sewing thread.

P-1019180



P-1019180



P-1019300

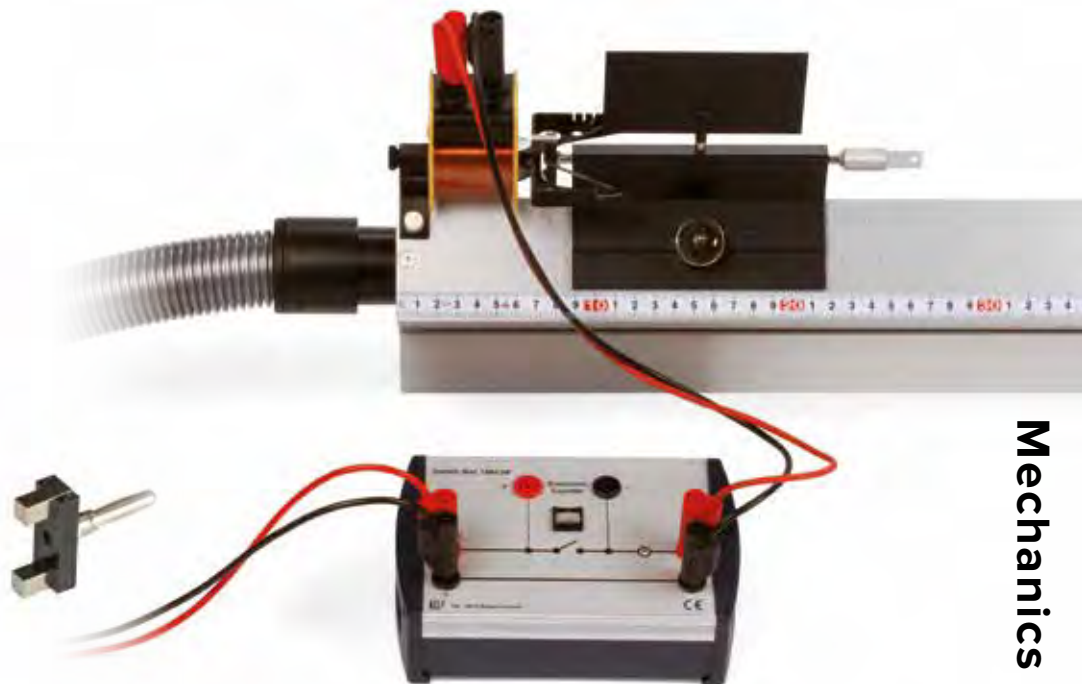

Experiment Topics:

- Newton's equations of motion
- Conservation of momentum and energy
- Elastic and inelastic collisions between equal and different masses
- Harmonic motion and coupled harmonic motion
- Trajectories
- Magnetic repulsion

! Advantage

- Numerous experiments can be carried out without the need for additional accessories

Air-Cushion Table

The air-cushion table possesses a flat glass surface serving as a base for recording paper and carbon paper. Compressed air is supplied to the pucks via light hoses. The air emerges from the bottom of the pucks, making them hover over the recording paper. The motion of the pucks is traced by means of spark recording. The air hoses contain thin metal chains via which a connection to the spark generator is established. The sparks jump over from a contact in the centre of the puck, leaving marks on the recording paper. As the pucks weigh 550 grams, their motion is not affected by the hoses or the attached spark wire.

Contents:

- 1 Experiment table with a glass surface, 580x580 mm²
- 1 Spark generator with a footswitch
- 1 Compressor with a hose
- 2 Steel pucks, 75 mm diam., 550 g
- 2 Puck collars with velcro fastener
- 2 Springs
- 1 Auxiliary puck weight, 150 g
- 1 Edge pulley, 45 mm diam.
- 1 Centre rod with sucker
- 1 Set of plotter paper
- 1 Set of special carbon paper
- 1 Operating manual

Air-Cushion Table (230 V 50/60 Hz)

P-1013210

Air-Cushion Table (115 V 50/60 Hz)

P-1012569

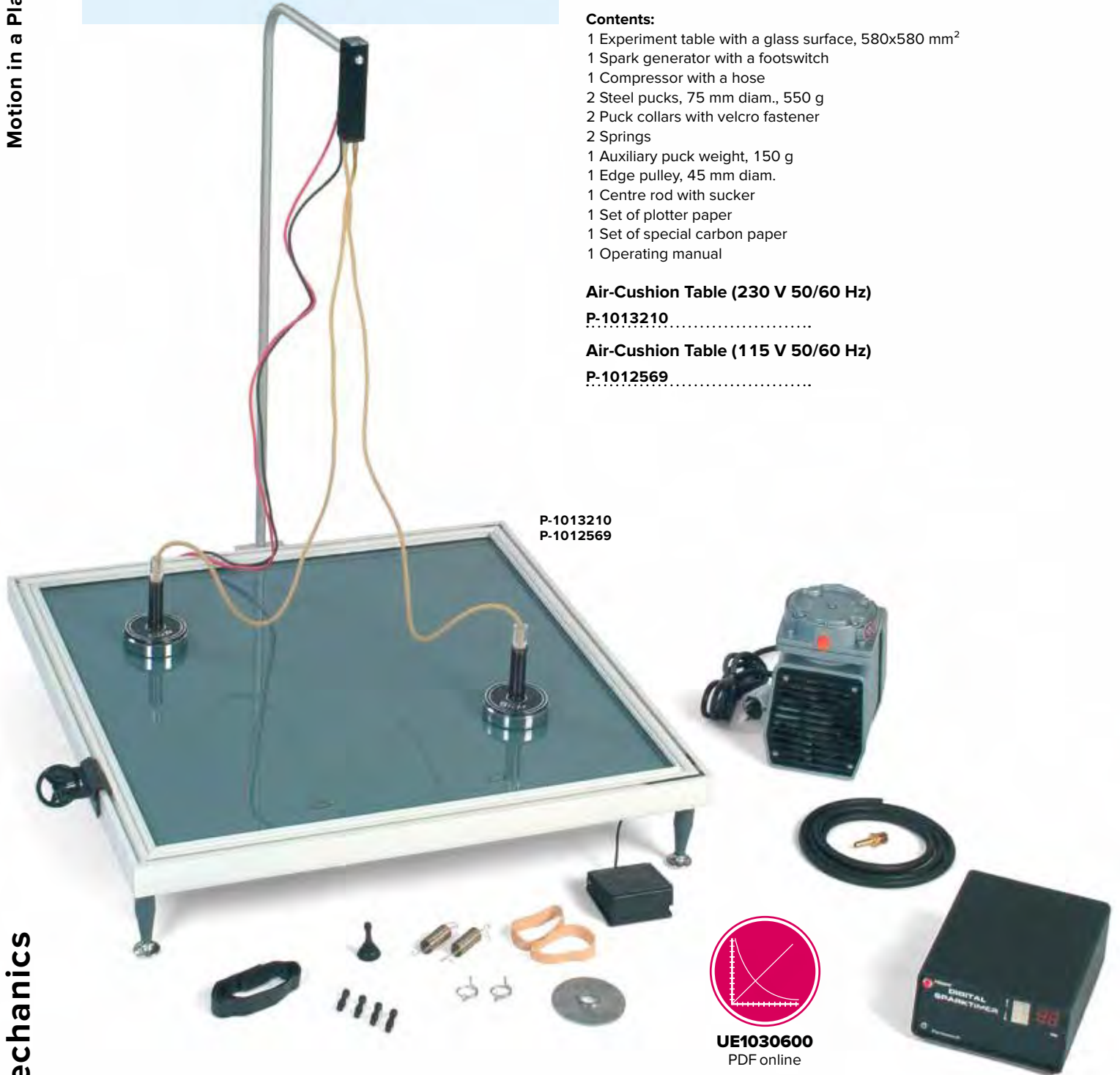

P-1013210
P-1012569

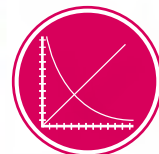

UE1030600
PDF online

Acrylic Puck

Acrylic puck for air-cushion table, for use as a second very light puck to demonstrate collisions between unequal masses. A steel puck is hardly deflected at all on collision with an acrylic puck.

Diameter: 75 mm
Weight: 90 g

P-1003362

Aluminium Puck

Aluminium puck for air-cushion table, for use as a second very light puck to demonstrate collisions between unequal masses.

Diameter: 75 mm
Weight: 210 g

P-1003363

Pair of Magnetic Pucks

A pair of pucks with extremely powerful magnets positioned such that the pucks repel each other. Intended for performing contactless collisions on the air-cushion table.

P-1003364

Puck Guide

Long acrylic rod with an internal spring which can be clamped between the inner edges of the air-cushion table. Intended to guide pucks for the purpose of recording harmonic oscillations.

Length: 590 mm

P-1003359

Set of Plotter Paper

100 sheets of printer paper for making pen plots in conjunction with an air-cushion table.

Dimensions: 510x580 mm²

P-1003361

Additionally required:

P-1003366 Set of Special Carbon Paper

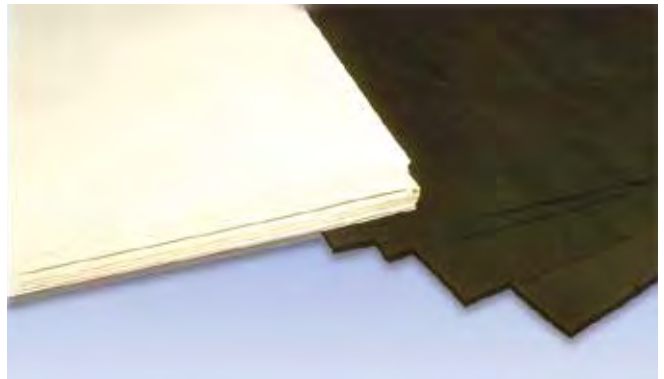

P-1003361

P-1003366

Set of Special Carbon Paper

10 sheets of carbon paper.

Dimensions: 550x550 mm²

P-1003366



Document your experiments with the air cushion clearly with the aid of the paper sets P-1003361 and P-1003366.

Example:
Elastic collision



Measuring acceleration due to gravity

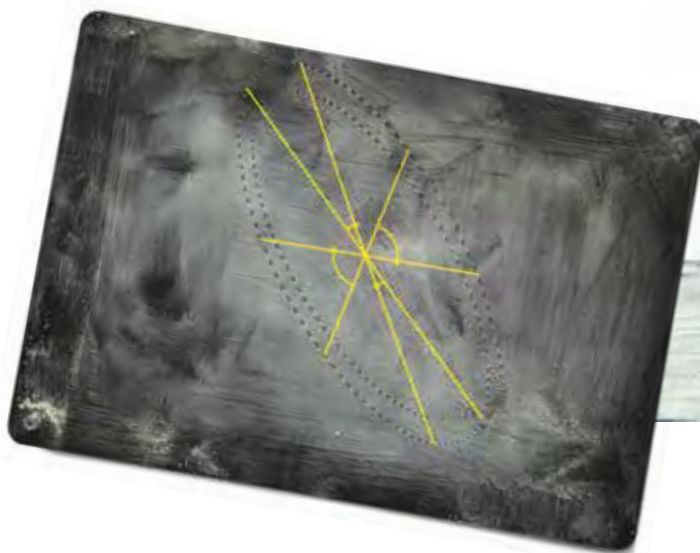

Plotting Movements in a Plane Using Powder Tracing

A plotting electrode slides over a plane counter electrode that is insulated and covered in powdered sulphur. An AC voltage across the two electrodes results in the sulphur powder being attracted or repelled depending on the

polarity of the plotting electrode. A trace thus appears in the powder with ridges that are formed at constant intervals of time. The distance between the ridges reflects the speed of the plotting electrode.

Pair of Elastic Balls with Plotting Electrode

Pair of balls with identical mass and sliding plotter electrode for experiments on elastic collisions that can be demonstrated by means of powder tracing. Made of red plastic with metal ball chain.

Diameter: 70 mm each
Weight: 300 g each

P-1000779

Additionally required:

P-1000739 Equipment Set for Powder Tracing



P-1000779

Pendulum with Plotting Electrode

Cylindrical pendulum bob with sliding plotter electrode for experiments to confirm Kepler's law governing areas covered by a body subject to a central force that can be demonstrated by means of powder tracing.

Steel, with metal ball chain.

Dimensions: 60 mm x 40 mm Ø
Weight: 500 g

P-1000780

Additionally required:

P-1000739 Equipment Set for Powder Tracing

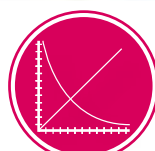

UE1030700
PDF online

P-1000780



Equipment Set for Powder Tracing

Set consisting of an insulated plate with 4-mm connector socket, a pulse generator and a transformer with two 4-mm plugs for its secondary winding, 35 g of powdered sulphur and a flat brush.

Transformer: Safety isolating transformer, short-circuit proof
Output voltage: 115 V – 230 V, safe to touch
Protective resistance: 1 MΩ
Plate dimensions: 390x270 mm²

P-1000739



P-1000739

Advantages

- Easy to set up
- Precise measurement of time with no systematic errors
- Height of fall can be set to the nearest millimetre
- No searching for lost balls

Free-Fall Apparatus

Apparatus for measuring the time it takes for a ball to fall a certain distance using a digital timer. Very easy to set up and use but nevertheless highly accurate. Includes 3 steel balls. A micro-magnet holds the ball in its start position. Three contact pins under the release mechanism ensure that the start position of the ball can be reproduced and act as the contacts of a switch that opens when the ball is released, thus triggering the beginning of the timing measurement. When the ball strikes the contact plate at the bottom, the timer is stopped. The ball is also held firmly on the plate so that it does not bounce. The height through which the ball drops can be adjusted to a fraction of a millimetre and read off a scale on the column.

Height scale: 20 – 960 mm

Scale divisions: 10 mm

Scale precision: 0.2 mm

Balls: Steel, 16 mm diam.

Dimensions: 200x130x1000 mm³ approx.

Weight: 1.6 kg approx.

P-1000738

Additionally required:

P-1012832 Millisecond Counter (230 V, 50/60 Hz)

or

P-1012833 Millisecond Counter (115 V, 50/60 Hz)

P-1002848 Set of 3 Safety Experiment Leads for Free-Fall Experiments

Set of 3 Steel Balls

Spare balls for the free-fall apparatus (P-1000738), launcher S (P-1000740) and marble in a bowl (P-1017332).

Diameter: 16 mm

P-4003748



Holder for Light Barrier

Holder to allow a light barrier (P-1000563) to be used with the free-fall apparatus (P-1000738).

P-1018448

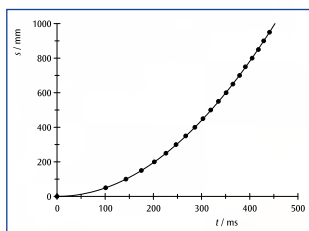

Time-displacement diagram for free fall

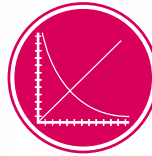
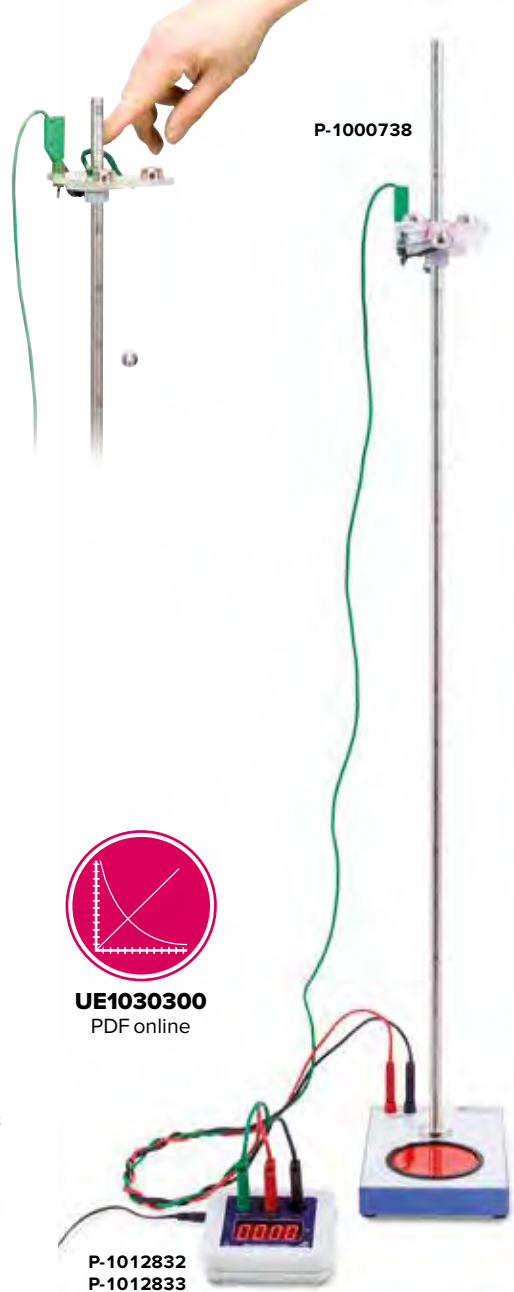

UE1030300
PDF online

Free-Fall Tube (Guinea and Feather Apparatus)

This glass pipe can be evacuated to compare the free falling characteristics of different objects in a vacuum. A cork, duck feathers and plastic parts are included as falling objects.

Length: approx. 800 mm

Diameter: 36 mm diam.

Hose nipple: 10 mm

Weight: approx. 1 kg

P-1000801

Additionally required:

P-1012855 Rotary-Vane Vacuum Pump, One-Stage

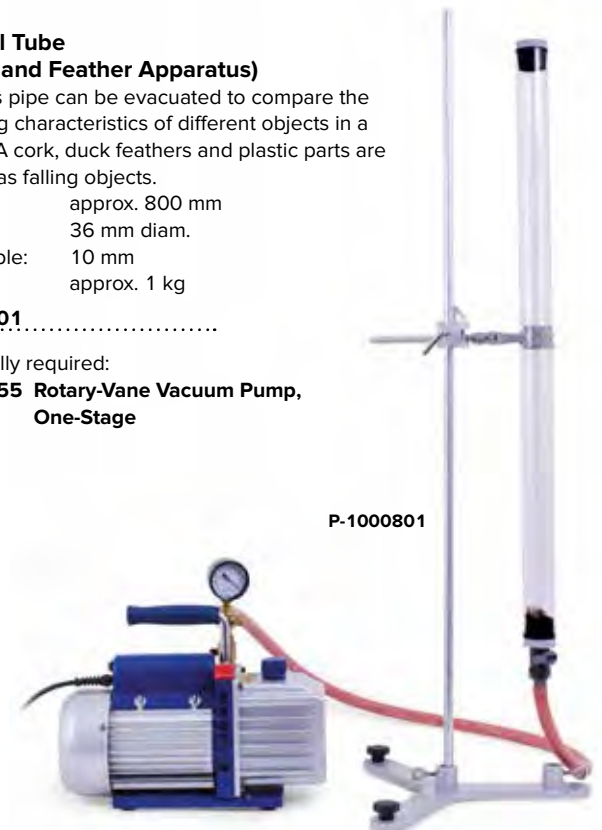

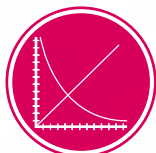

UE1030400
PDF online



P-1002654

P-1002655

Advantages

- Three reproducible launch speeds
- Continuous adjustment of launch angle
- Constant height of trajectory, independent of angle setting
- Balls launched with no rotational spin

Projectile Launcher

Experimental equipment for the quantitative investigation of projectile laws: vertical horizontal and angled launch, recording of flight trajectories depending on launch angle and projectile range. Three different reproducible launch speeds, continuously adjustable launch angles, constant height of trajectory at various angles since the launch point is coincident with pivot point of the cannon. Projectile is launched with almost no spin. The encapsulated design and the use of spherical plastic projectiles ensure that experiments are safe. The launcher is attached to a table via clamp (P-1002655) or can be used in conjunction with ballistic pendulum (P-1002656).

Horizontal projectile

range (Launch angle 45°): 1.1 m, 2.3 m and 4.5 m

Launch angle: 0° – 90°

Reproducibility at 45°: standard deviation less than 1%

Standard deviation of

launch ranges: < 1%

Diameter of projectiles: 25 mm

Mass of projectiles: 7 g

Dimensions: 205x65x60 mm³ approx.

Mass: 480 g approx.

Contents:

- 1 Launcher
- 3 Plastic projectile balls
- 1 Ramrod
- 1 Wing nut M8x20

P-1002654

Additionally required:

P-1002655 Clamp for Projectile Launcher

or

P-1002656 Ballistic Pendulum

Protective Goggles

Additionally recommended:

P-1002657 Photo Gate Holder for Projectile Launcher

P-1000563 Photo Gate

Experiment Topics:

- Vertical, angled and horizontal launch
- Recording of the trajectory with an angled launch
- Determination of range and height from the projection angle
- Determination of launch speed from the range and height
- Determination of launch speed using a ballistic pendulum
- Elastic and inelastic collisions

Clamp for Projectile Launcher

Table clamp for Projectile Launcher (P-1002654) made of anodized aluminium.

Span: 10 mm – 65 mm

Dimensions: approx. 150x70x80 mm³

Mass: approx. 710 g

P-1002655

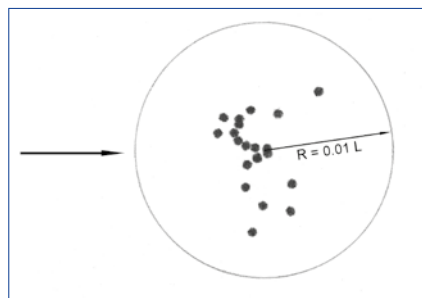

Typical results for measurement of 20 shots. L = range.

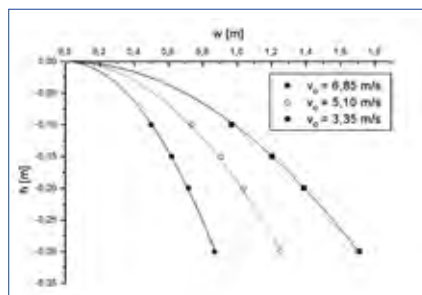

Horizontal launch: projectile height as a function of the projectile distance

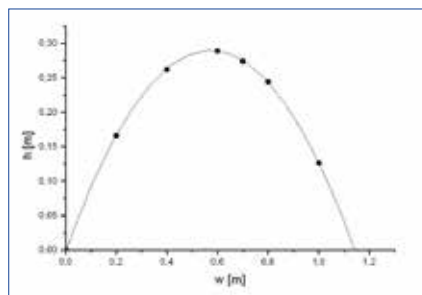

Oblique launch: projectile height as a function of the projectile distance (launch angle: 45°)

Ballistic Pendulum

Accessories for the (P-1002654) launcher for use in experiments on elastic and inelastic collision or to be used as a holder for experiments on trajectory. The speed of the balls as measured in launcher experiments or pendulum experiments agree to within approximately $\pm 3\%$. Additional weights can be used to investigate how pendulums behave with differing angles of deflection at the same speed. For experiments investigating trajectories, the launcher can be set to 5 different launch heights 5, 10, 15, 20 and 30 cm when it is attached to the rear of the ballistic pendulum.

- Height of pendulum: 370 mm
- Extra weights: 17.5 g each
- Base plate: 130x130 mm²
- Span of bench clamp: 10 – 65 mm
- Mass: 2.1 kg

Contents:

- 1 Ballistic pendulum with table clamp
- 2 Extra weights

P-1002656

Additionally required:

P-1002654 Projectile Launcher



P-1002656

P-1002654



P-1002657

Photo Gate Holder for Projectile Launcher

Holder for mounting the photo gate (P-1000563) at the exit of the projectile launcher (P-1002654).

P-1002657

Set of 3 Steel Balls

Spare balls for the free fall apparatus (P-1000738), launcher S (P-1000740) and marble in a bowl (P-1017332).

Diameter: 16 mm

P-4003748

Launcher S

Experimental apparatus for studying vertical and horizontal trajectories as well as trajectories starting at intermediate angles. Also demonstrates the independence of the horizontal and vertical components of motion (for projectiles). Provides for three different launch velocities. Angle of launch can be adjusted to any arbitrary angle and read off from a protractor scale with a plumb line. The projectile ball is held in place by a magnet until the moment of launch so that the height of the trajectory is independent of the launch angle. When a projectile is launched, a second ball can be released simultaneously from the other side of the launcher that then descends in free fall. The latter should strike the floor at the same time as the projectile if the launch angle is horizontal.

- Launch angle: 0° – 90°
- Maximum range: 4 m
- Projectile diameter: 16 mm
- Projectile weight: 17 g
- Diameter : 280x90x90 mm³ approx.
- Total weight: 950 g approx.

P-1000740

Additionally required:

P-1002934 Stainless steel rods, 470 mm (2x)

P-1002832 Table clamps (2x)

Protective goggles



P-1000740

P-4003748

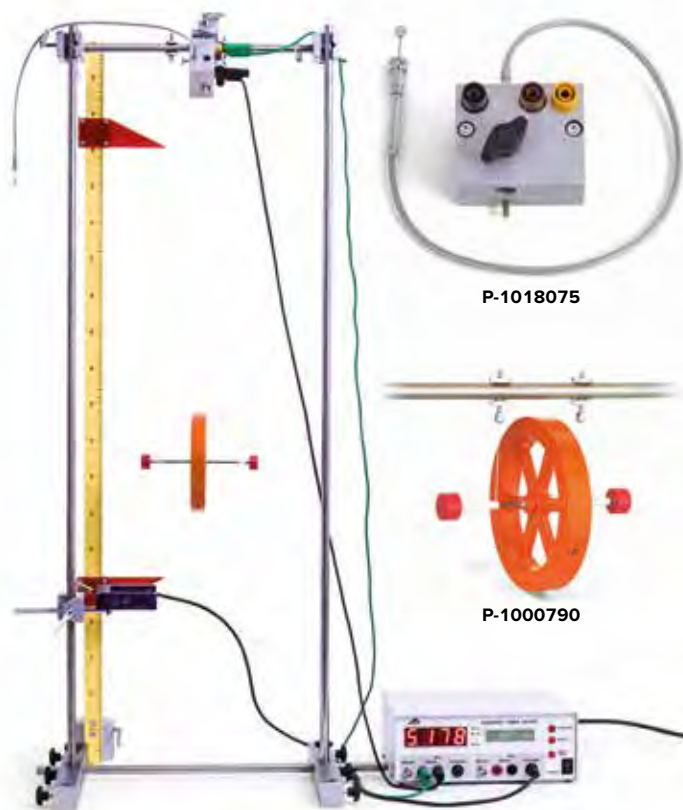

Measurement of fall time

Trigger Device for Maxwell's Wheel

Mechanic start device for triggering a well defined start instant for Maxwell's wheel. With 4-mm sockets for connecting to the start input of the digital counter. Triggering via Bowden cable.

Hole for stand rod: 10 mm diam.

Dimensions: 60x50x50 mm³ approx.

Mass: 260 g approx.

P-1018075

Maxwell's Wheel

Spoked wheel with large moment of inertia for demonstrating conservation of energy in the conversion of kinetic energy to potential energy and vice versa. Includes suspending rod and adjustable suspension mechanism. The rotating axle is held in a horizontal position by two strings attached to a suspending rod and is moved upward by winding in the strings. If the equipment is released from its wound in position, the spoked wheel acquires kinetic energy on the way down, which can be seen by the constant increase in its speed of rotation. Two stops on the ends of the axle prevent the wheel from spinning free. At the lowest point when the strings are fully unwound, they start rewinding around the axle and the wheel rises upward again, losing its kinetic energy as it gets higher. To measure the inertial force during acceleration, the whole apparatus complete with stand is placed on a set of scales.

Moment of inertia: 10 kg cm² approx.

Diameter of wheel: 130 mm approx.

Mass of wheel: 370 g approx.

Suspending rod: 370 mm x 12 mm diam.

P-1000790

Additionally recommended:

P-1002936 Stainless Steel Rod 1000 mm (2x)

P-1018874 Stand with H-Shaped Base

P-1002830 Universal Clamp (4x)

P-1012848 Stainless Steel Rod 280 mm

P-1018075 Trigger Device for Maxwell's Wheel

P-1000563 Photo Gate (2x)

P-1001033 Digital Counter/Timer (230 V, 50/60 Hz)

or

P-1001032 Digital Counter/Timer (115 V, 50/60 Hz)

Atwood's Machine

Experiment for studying motion under constant acceleration, demonstrating Newton's second law and determining the acceleration due to gravity g . Includes an aluminium stand for affixing to a wall. A string with weights at both ends is passed over a rotating pulley. The set-up undergoes relatively slow but constant acceleration if the weights are slightly different. This motion is initiated by a tug on one string and stops when the dropping weight strikes a movable platform. To show the rotation of the pulley, it is divided into 20 segments of equal angle. It can easily be removed to measure its moment of inertia.

Axis: Mounted on ball bearing

Diameter of pulley: 152 mm

Thickness of pulley: 10 mm

Weights: 150 g each

Slotted weights: 1x 5 g, 2x 2 g, 1x 1 g each

P-1003367

Additionally required:

P-1003369 Mechanical Stopwatch, 15 min



P-1000588

Free Fall and Horizontal Launch Equipment

Equipment for demonstrating the independence of the horizontal and vertical components of motion (for projectiles). A launching rail with returning spring is mounted on a wooden base. Two steel balls are used as test bodies. Upon triggering, one ball starts to fall downwards and simultaneously the other is launched horizontally. Both balls hit the ground at the same time. Two holes in the base plate are provided for storing the balls.

Ball diameter: 15 mm

Dimensions: 200x120x30 mm³ approx.

Mass: 230 g approx.

P-1000588



P-1003367

Marble in a Bowl

Concave transparent acrylic body with spherical curvature. A rolling ball oscillates inside the concavity about its rest position like a mathematical pendulum does. The radius of curvature is equivalent to the length of a normal pendulum. Includes three steel balls.

Diameter of balls: 16 mm
 Radius of curvature: 200 mm
 Diameter: 140 mm

P-1017332

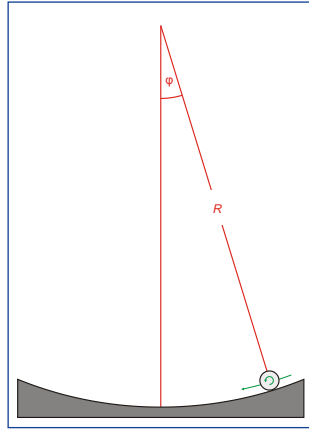

P-1017332

Set of 6 Steel Balls

Ball bearings made of hardened and polished steel. Can be used with a guide rail for experiments on elastic collisions or in combination with watch glasses to demonstrate various states of equilibrium. Rail not included.

Diameter: 30 mm each
 Weight: 110 g each

P-1002939

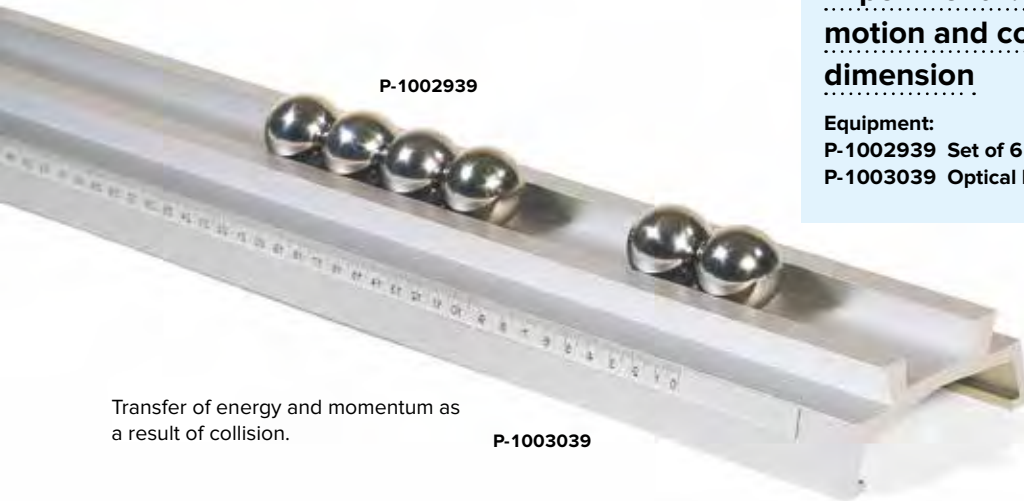

P-1002939

Transfer of energy and momentum as a result of collision.

P-1003039

Experiment 1: Investigation of motion and collisions in a single dimension

Equipment:

- P-1002939 Set of 6 Steel Balls
- P-1003039 Optical Bench U, 1200 mm

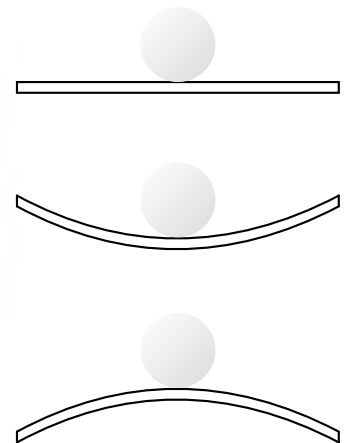

Experiment 2: Stable, unstable and neutral equilibrium

Equipment:

- P-1002939 Set of 6 Steel Balls
- P-1002868 Set of 10 Watch Glass Dishes, 80 mm
- P-1002869 Set of 10 Watch Glass Dishes, 125 mm
- P-1003190 Plane Mirror

P-1003190

Neutral equilibrium



P-1002868

Stable equilibrium



P-1002869

Unstable equilibrium



Experiment Topics:

- Rotational motion: uniform and under constant acceleration
- Newton's equations of motion for rotational motion
- Moment of inertia and torque
- Moment of inertia as determined by experiment
- Simple harmonic motion of rotating objects

Rotating System on Air Bed

Apparatus for investigating frictionless rotation. A small rotating disc with a protractor scale supports a cross bar to which weights can be attached. The disc is supported by a bed of air in which its axis is centred. A driving weight is suspended from a hook at the end of a string that is passed over a single pulley on one side and a multiple pulley on the other. The rotation is very slow and can be measured using a stopwatch by hand. Alternatively, a digital timer may be used. This can be started by a mechanism that is supplied with the kit and halted by a signal from a laser reflection sensor when the wheel passes through angle zero.

Protractor scale:	0 – 360°
Scale divisions:	1°
Length of cross bar:	ca. 440 mm
Radii of perforations:	30 – 210 mm
Separation of perforations:	20 mm
Radii of multiple pulley:	5.0 mm/10.0 mm/15.0 mm
Moment of inertia of disc with cross bar:	0.9 g m ² approx.
Maximum moment of inertia:	7.1 g m ² approx.

Minimum driving torque:	0.05 mN m approx.
Maximum driving torque:	0.60 mN m approx.

Contents:

- 1 Air bed
- 1 Rotating disc with cross bar
- 1 Multiple pulley
- 1 Release mechanism
- 2 S-shaped hooks 1.00g
- 1 S-shaped hook 2.00 g
- 1 Set of weights (2x 12.5 g, 2x 25 g, 2x 50 g)
- 1 Compressor for connection to mains
- 1 Silicon tubing with by-pass valve (not illustrated)
- 1 Pulley
- 1 Stand rod with 3 securing screws and 2 screws for levelling
- 1 Stand rod with 2 securing screws
- 1 Stand rod, 250 mm
- 1 Levelling disc
- 1 Roll of thread

Rotating System on Air Bed (230 V, 50/60 Hz)**P-1000782****Rotating System on Air Bed (115 V, 50/60 Hz)****P-1000781**

Additionally recommended:

P-1001034 Laser Reflection Sensor**P-1001033 Digital Counter/Timer (230 V, 50/60 Hz)**

or

P-1001032 Digital Counter/Timer (115 V, 50/60 Hz)**P-1000783 Supplementary Kit for Rotating System on Air Bed****Supplementary Kit for Rotating System on Air Bed**

Supplementary kit for the rotating system on air bed (P-1000782 / P-1000781) for investigating frictionless rotational motion and oscillations using a large rotating disc. On the underside of the large disc is an angle grid that can be used to provide triggers to a laser reflection sensor (P-1001034) if the rotation is to be recorded with the help of the 3B NET/log™ interface unit.

Typical oscillation periods: 20 s approx. to 2 mins approx.

Moment of inertia of large disc: 2.2 g m² approx.**Contents:**

- 1 Large disc with protractor scale, 350 mm
- 1 Scaffold stand
- 1 Cross sleeve
- 1 Set of coupling springs with magnet (1 N, 2 N, 5 N)

P-1000783

Additionally recommended:

P-1001034 Laser Reflection Sensor and**P-1001033 Digital Counter (230 V, 50/60 Hz)** or**P-1001032 Digital Counter (115 V, 50/60 Hz)** or**P-1000540 3B NET/log™ (230 V, 50/60 Hz)** or**P-1000539 3B NET/log™ (115 V, 50/60 Hz)**

Measuring the period of oscillation and determining the moment of inertia

Watt's Governor

Symmetrical pendulum system on an axle, for demonstrating centrifugal force. The pendulum arms are held in a state of rest by a coil spring. Depending on the rotational speed, they are lifted against the force of gravity as the axle turns. This can then be used to control the speed of a steam engine.

Rotation diameter: 350 mm
 Height: 250 mm
 Diameter of axle: 10 mm

P-1009695

Additionally required:

P-1002663 Experiment Motor with Gearbox

P-1002832 Table Clamp

P-1003312 DC Power Supply 0 – 20 V, 5 A (230 V, 50/60 Hz)

or

P-1003311 DC Power Supply 0 – 20 V, 5 A (115 V, 50/60 Hz)

Additionally recommended:

P-1003331 Digital Stroboscope (115 V, 50/60 Hz)

or

P-1003330 Digital Stroboscope (230 V, 50/60 Hz)



P-1009695

Experiment Motor with Gearbox

Experiment motor for universal use in experiments on rotational motion, e.g. for experiments using the Watt's governor (P-1009695). Can also be used as a generator in conjunction with the included hand crank. Robust clockwise and counter-clockwise rotating IDC motor with epicyclic gearbox and quick-action chuck in a tough anodized aluminum casing with removable and adjustable stainless steel stand rod. Can also be mounted on the clamp for the projectile launcher (P-1002655). Speed of rotation is adjusted by altering the supply voltage. Adjustable torque. Includes 3 belt pulleys of different diameters on a mounting axle.

Speed without load: approx. 480 rpm at 12 V
 Speed sensitivity: approx. 40 rpm per V
 Span of chuck: 0.8 to 10 mm
 Stand rod: 12 mm diam.
 Pulleys: 10 mm diam., 20 mm diam., 40 mm diam.
 Axle: 10 mm diam.
 Drive belt: 130 mm diam. x 4 mm
 Nominal voltage: 12 V DC, 5A
 Connection: via 4-mm safety sockets
 Dimensions: 210x95x60 mm³
 Mass: 1.2 kg

P-1002663

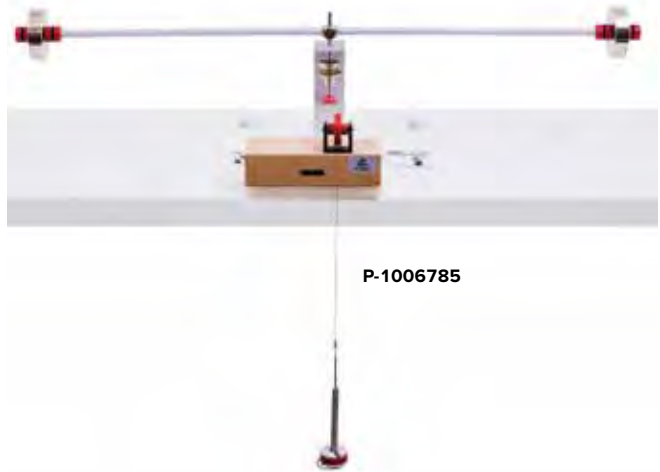

P-1006785

Rotation Apparatus

Rotating apparatus for determining angular acceleration as a function of the torque and for determining the moment of inertia depending on mass and distance from an axis. An axle on agate bearings supports a cross bar to which weights can be attached. The force from a driving weight is conveyed to the axle via a string wrapped around the axle and passed over a pulley and a second multiple pulley on the axle itself.

Length of crossbar: 600 mm
 Radii of multiple pulley: 4.5 mm / 9.0 mm
 Driving weights: 10 g / 20 g / 30 g / 40 g / 50g
 Inertial mass of disc(s): 100 g / 200 g / 300 g
 Dimensions of base plate: 200x140 mm²
 Total weight: 1.3 kg approx.

Contents:

- | | |
|-----------------------------------|------------------------|
| 1 Basic apparatus | 2 Slotted weights 10 g |
| 2 100-g discs | 1 Slotted weight 20 g |
| 2 200-g discs | 1 Pulley |
| 1 Holder for slotted weights 10 g | 1 Roll of string |

P-1006785

Additionally recommended:

P-1003331 Digital Stroboscope (115 V, 50/60 Hz)

or

P-1003330 Digital Stroboscope (230 V, 50/60 Hz)



P-1002663

Contents:

- | | |
|-------------------------------|------------|
| Experiment motor | Hand crank |
| Stand rod with knurled screws | Pulleys |
| | Drive belt |

Additionally required:

P-1003312 DC Power Supply 0 – 20 V, 5 A (230 V, 50/60 Hz)

or

P-1003311 DC Power Supply 0 – 20 V, 5 A (115 V, 50/60 Hz)

Experiment Topics:

- Moment of inertia of a disc
- Torque
- Angular momentum
- Precession
- Nutation



UE1040500
PDF online

P-1000695

Gyroscope

High quality precision made gyroscope for demonstration as well as for quantitative determination of gyroscopic laws by means of practical experiments. Experiment apparatus with a shaft that can be tilted and rotated while attached to a stand rod. On one side of the shaft there is a disc mounted on dual ball bearings, while on the opposite side there is a movable counterweight for establishing equilibrium. Fine adjustment is performed by thumb screw at the end of the shaft. To generate external torque an additional weight is provided that can also be moved along the shaft. The shaft's angle of inclination can be read from an easily readable scale. A spirit level allows the gyroscope to be adjusted to the horizontal. The disc can be set rotating by hand or by means of a cord. The dual ball bearing system ensures that rotation is nearly frictionless and that rotation continues for lengthy periods of time. The open construction of the gyroscope allows gyroscopic phenomena to be observed easily and clearly.

Scale:	- 40° to + 40°	Mass of
Scale divisions:	1°	additional weight:
Disc:	250 mm diam.	Total weight:
Mass of disc:	1500 g	
Mass of counterweight:	1400 g	

P-1000695



P-1000698

Gyroscope Accessories

Accessories kit for Gyroscope (P-1000695) consisting of a gyroscope disc and counterweight. For demonstrating the canceling out of gyroscopic phenomena in the case of two discs rotating at the same speed in opposite directions.

P-1000698

Bicycle Wheel Gyroscope

Spoked wheel with weighted rim for demonstrating conservation of angular momentum. Simple to use due to small wheel radius and ease of suspension.

Diameter: 500 mm

P-1003489

Additionally recommended:

P-1003490 Turn Table

P-1001055 Experiment Cord



P-1003489



P-1003490

Gyroscope S

Gyroscope with low-profile, dynamically balanced metal rotor in a Cardan gimbal mount. Ideal for studying gyroscopic stability phenomena, precession and nutation. Also supplied is a pendulum mounting that can be used for investigating the rolling or tipping moment. The set includes plastic Cardan discs, Cardan gimbal mount, pendulum mounting and starting cord.

Dimensions: 170x120 mm² approx.

P-1013228



P-1013228

Turn Table

Intended for use with the bicycle wheel gyroscope, this rotary platform allows operation on a laboratory stool or as a base surface. Anti-skid design.

Diameter: 300 mm

P-1003490



Advantages

- Low-friction needle bearing
- Electromagnetic angle sensor

Pendulum Rod with Angle Sensor

Pendulum with low-friction pointed bearings and electromagnetic angle sensor for measuring simple harmonic motion of a weighted pendulum with movable weight. Including plug-in power supply. The deflection of the pendulum is detected by a Hall sensor that converts the angle to an electrical signal proportional to the angle so that the oscillation can be recorded using an interface unit, a Y-t plotter or a storage oscilloscope.

Length of pendulum: 1 m
 Mass of pendulum: 1 kg
 Output voltage: ± 5 V
 Output resistance: 500 Ω
 Power supply: 12 – 16 V AC
 Diameter of tube: 10 mm
 Weight: 1,4 kg approx.

Pendulum Rod with Angle Sensor (230 V, 50/60 Hz)

P-1000763

Pendulum Rod with Angle Sensor (115 V, 50/60 Hz)

P-1000762

Additionally required:

- P-1002832 Table clamp
- P-1002936 Stainless steel rod, 1000 mm
- P-1002830 Universal clamp

Additionally recommended:

- P-1000540 3B NET/log™ (230 V, 50/60 Hz)
- or
- P-1000539 3B NET/log™ (115 V, 50/60 Hz)

Set of 4 Pendulum Bobs

4 balls with securing eyes: made of brass, aluminium, steel and plastic for constructing a mathematical pendulum.

Diameter: 25 mm
 Weights: 71.2 g, 25.2 g, 61 g, 10.5 g

P-1003230

Additionally required:

- P-1001055 Experiment Cord
- Stand Equipment



P-1003230

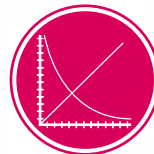

UE1050600
PDF online

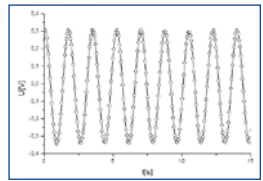

Deflection of the pendulum as a function of time



P-1000763
P-1000762

Rod Pendulum (not shown)

Rod pendulum with low-friction pointed bearings as per P-1000763 or P-1000762 but with no Hall sensor or magnet for detecting angle.

P-1000764

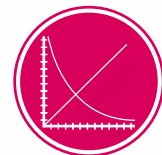

UE1050600
PDF online



Chaotic Pendulum E

A double pendulum made of anodised aluminium for mounting on a rigid wall. Both lengths of the pendulum are manufactured with the utmost precision and rotate, or oscillate, without friction around their axis. The way the movement develops is unpredictable and therefore chaotic. Depending on the initial conditions, the pendulum lengths begin rotate and lose energy due to friction. Once the energy is no longer sufficient, the rotation gives way to oscillation. The motion of each of the pendulums is affected by the other. This means that the rotation of the second length can be transferred to the first, which may provide it with enough energy to rotate again. The chaotic pendulum stops when all the energy has been lost due to friction.

Dimensions: 350x38x52 mm

P-1017531

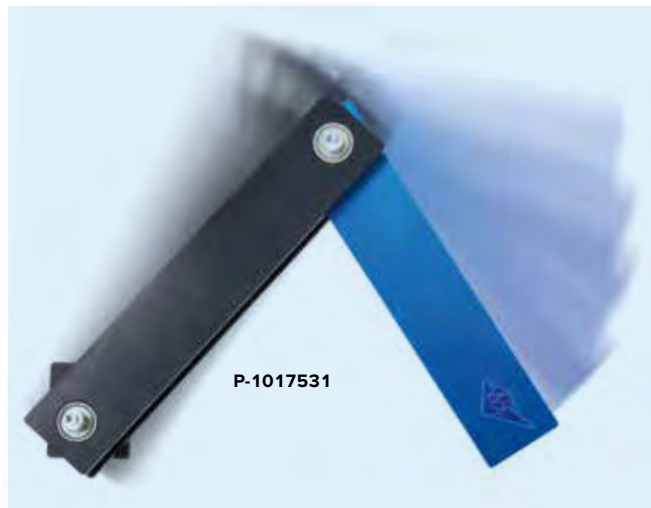

P-1017531

Variable g Pendulum

Pendulum with continuously adjustable plane of oscillation for observing pendulum oscillations where the acceleration due to gravity g can appear to be varied.

Max. length of pendulum: 280 mm

Mass of pendulum: 0.5 kg

Angle of plane

of oscillation: $0^\circ - 90^\circ$

Dimensions: 300x250x550 mm³

Mass: approx. 5 kg

P-1000755

Additionally required:

P-1002836 Stand Base, Tripod, 185 mm

P-1002934 Stainless Steel Rod, 470 mm

Additionally recommended:

P-1000756 Photogate Holder for Pendulum

P-1000563 Photo Gate

P-1001033 Digital Counter (230 V, 50/60 Hz)

or

P-1001032 Digital Counter (115 V, 50/60 Hz)



P-1000755

P-1000756

P-1002934

P-1002836

P-1000563



UE1050201
PDF online

P-1001033
P-1001032

Photogate Holder for Pendulum

Holder for mounting the light barrier (P-1000563) with a variable-g pendulum, for which the plane of oscillation can be set at any angle.

P-1000756

Experiment Topics:

- Harmonic oscillations
- Determining unknown masses
- Gravitational mass and inertial mass



Inertia Balance

Inertia balance for determining inertial mass. After the apparatus is calibrated by determining the vibration frequency for objects of known mass, it can be used to determine the unknown masses. The Inertia Balance consists of two metal trays connected by stiff steel spring strips. One tray has 3 holes to hold up to three masses and the other tray may be anchored to a table edge or laboratory bench with the included table clamp.

Length of steel strip: approx. 350 mm
 Masses: approx. 175 g each

Contents:

- 1 Inertia Balance
- 1 Table clamp
- 1 Cord, 1.85 m
- 3 Masses

P-1003235

Additionally required:

P-1003369 Mechanical Stopwatch, 15 min

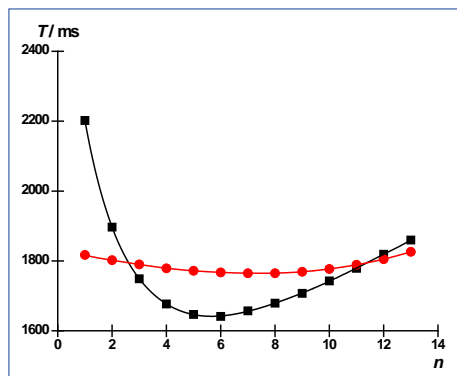

Periods of oscillation around both fulcra as a function of the position of the sliding weight

Experiment Topics:

- Measurement of periods of oscillation of Kater's reversible pendulum for two fulcra
- Adjustment of Kater's reversible pendulum for equal periods of oscillation
- Determination of acceleration due to gravity

new

Kater's Reversible Pendulum

Special form of physical pendulum for determining local acceleration due to gravity g . Pendulum rod with two fulcra plus one sliding and one fixed disc weight for adjusting the period of oscillation. When correctly adjusted, the pendulum will oscillate about both fulcra with the same period of oscillation. The pendulum is suspended from very low-friction needle bearings on a highly stable support. In order to adjust orientation, the support is equipped with two adjustment screws and a spirit level. Includes mounting plate for light barrier.

Height of apparatus

with pendulum: 1.25 m approx.

Length of pendulum rod: 1.2 m

Separation of bearing points: 800 mm

Period of adjusted pendulum: 1794 ms when $g = 9.81 \text{ m/s}^2$

Total weight: 6.3 kg approx.

P-1018466

Additionally required:

P-1000563 Light Barrier

P-1001033 Digital Counter (230 V, 50/60 Hz)

or

P-1001032 Digital Counter (115 V, 50/60 Hz)

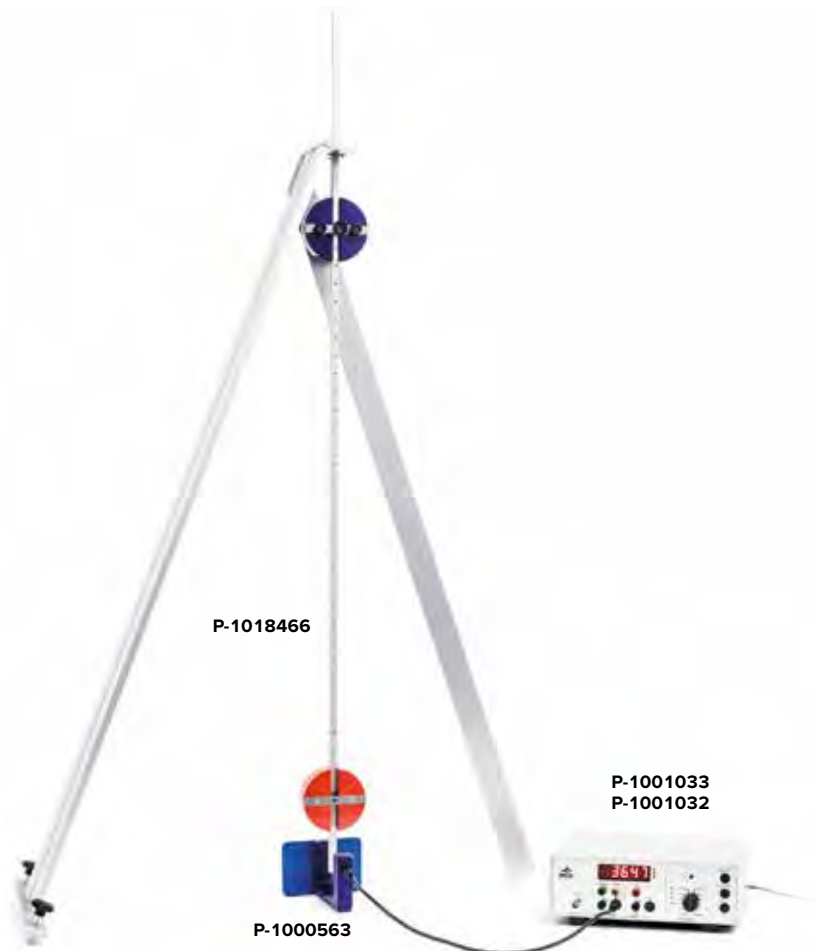

Mechanical Oscillations in a Space-Saving Tabletop Experiment

SW Sensors Set

Set incorporating two dynamometers and an amplifier board for recording and analysing mechanical oscillations using a standard oscilloscope. The dynamometers can be fitted to 10-mm diameter stands or the SW tie bar in order to measure dynamic forces along their axes. The amplifier board converts signals from both dynamometers so that they can be recorded and also evaluates the phase differences between both oscillation signals, outputting them as a DC signal. If the MEC amplifier board is connected to the 2x 50 MHz USB oscilloscope (P-1017264), it is possible to perform detailed analysis and evaluation of measured signals using the oscilloscope software on a PC.

Dynamometers:

- Maximum force: 5 N
- Frequency range: 0.3 – 200 Hz
- Connectors: 3.5-mm jack plugs
- Dimensions: 52x37x26 mm³

MEC amplifier board:

- Input sockets: 3.5-mm jack sockets
- Output sockets: BNC
- Dimensions: 65x100x40 mm³

Contents:

- 2 Dynamometers
- 1 MEC amplifier board
- 1 Power supply, 12 V AC, 700 mA
- 2 HF Patch cords

SW Sensors Set (230 V, 50/60 Hz)

P-1012850

SW Sensors Set (115 V, 50/60 Hz)

P-1012851

Additionally recommended:

- P-1017264 USB Oscilloscope 2x 50 MHz
- or
- P-1008695 Analogue Oscilloscope 2x20 MHz (230 V, 50/60 Hz)

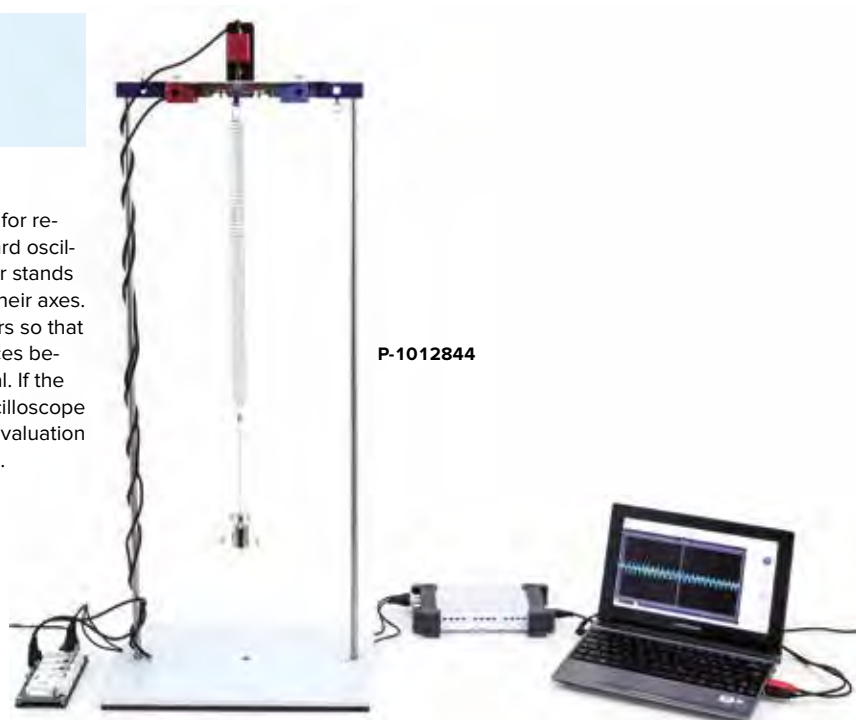

P-1012844

SW Wilberforce Pendulum Set

Set for building a Wilberforce pendulum or a torsion pendulum in a space-saving table-top experiment. Adjustable rotating body for fine adjustment of moment of inertia in order to investigate couples translation and rotation oscillations as per Wilberforce's experiment. Includes components for connecting to dynamometers from the SW Sensors set in order to record and comprehensively analyse oscillations using a standard oscilloscope.

Contents:

- 1 Spring, 5 N/m
- 1 Rotating body
- 1 Vertical plate
- 1 Body with hook
- 1 Spring set B for fitting to dynamometer

P-1012844

Additionally required:

P-1012849 SW Stand Equipment Set

Additionally recommended:

- P-1012850 SW Sensors Set (230 V, 50/60 Hz)
- or
- P-1012851 SW Sensors Set (115 V, 50/60 Hz)
- P-1017264 USB Oscilloscope 2x 50 MHz
- or
- P-1008695 Analogue Oscilloscope 2x 20 MHz (230 V, 50/60 Hz)



P-1012850
P-1012851

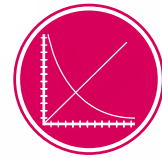

UE1050121
PDF online

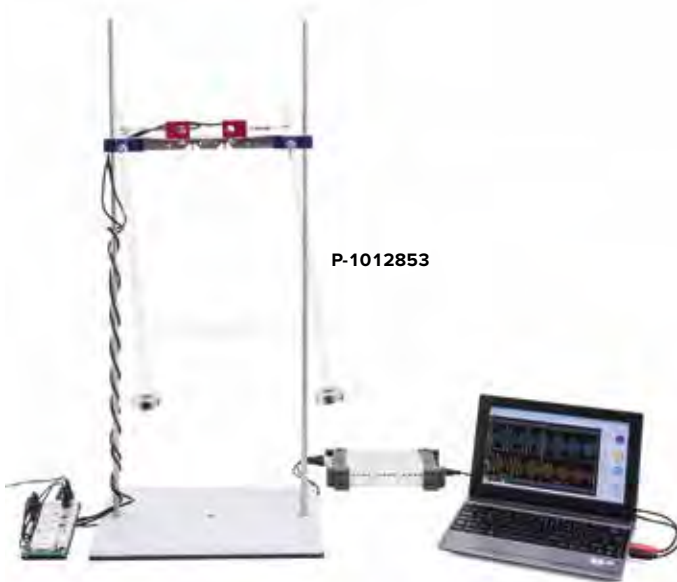

P-1012853

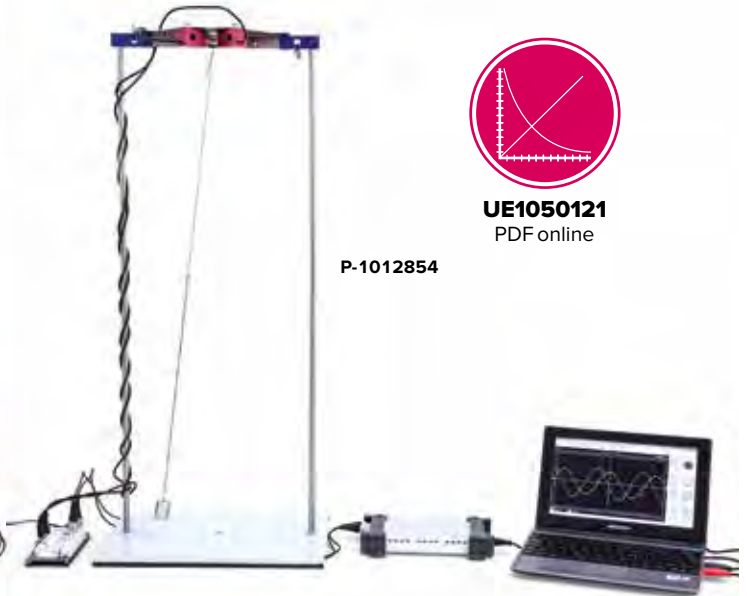

P-1012854

SW Physical Pendulum Set

Versatile set for building a physical pendulum with a moveable weight, a reversing pendulum or a pair of coupled pendulums in a space-saving table-top experiment. Includes components for connecting to dynamometers from the SW Sensors set in order to record and comprehensively analyse oscillations using a standard oscilloscope.

Contents:

- 2 Bearing bars
- 2 Pendulum rods
- 2 Weights, 200 g
- 1 Weight, 150 g
- 1 Acrylic ring
- 1 Spring, 2.5 N/m
- 2 Coupling spring sets C

P-1012853

Additionally required:

P-1012849 SW Stand Equipment Set

Additionally recommended:

P-1012850 SW Sensors Set (230 V, 50/60 Hz)

or

P-1012851 SW Sensors Set (115 V, 50/60 Hz)

P-1017264 USB Oscilloscope 2x 50 MHz

or

P-1008695 Analogue Oscilloscope 2x 20 MHz (230 V, 50/60 Hz)

SW String Pendulum Set

Kit for easy assembly of a string pendulum for comprehensive investigation of simple harmonic motion and chaotic oscillations in a space-saving table-top experiment. Features movable string pulley for setting string lengths and magnetic strips for generating chaotic oscillations. Other components are for connecting to dynamometers from the SW Sensors set in order to record and analyse oscillations with two degrees of freedom using a standard oscilloscope.

Contents:

- 1 String, 100 m
- 1 Weight, 100 g
- 1 Long magnetic strip
- 2 Short magnetic strips
- 1 Spring set A for fitting to dynamometer

P-1012854

Additionally required:

P-1012849 SW Stand Equipment Set

Additionally recommended:

P-1012850 SW Sensors Set (230 V, 50/60 Hz)

or

P-1012851 SW Sensors Set (115 V, 50/60 Hz)

P-1017264 USB Oscilloscope 2x 50 MHz or

P-1008695 Analogue Oscilloscope 2x 20 MHz (230 V, 50/60 Hz)

SW Stand Equipment Set

Stand equipment for easy, understandable and stable assemblies, e.g. for investigating mechanical oscillations and waves using the sensors from the SW sensors set (P-1012850 or P-1012851). Including SW base plate as non-tilting base to accommodate the stand rods, two double clamps and SW tie bar. The SW tie bar serves as multi-function holder for fitting between stand rods on the base plate in order to build set-ups featuring the dynamic force sensors from the SW sensors set.

Base plate: 345x240x16 mm³ approx.

Stand rods: 400 mm x 10 mm dia. approx.

Contents:

- 1 SW Base plate
- 2 Stand rods with internal and external thread
- 2 Stand rods with external thread
- 2 SW Double clamps
- 1 SW Tie bar

P-1012849

Additionally recommended:

P-1012848 Steel Rod 280 mm

P-1012847 Steel Rod 400 mm



P-1012849

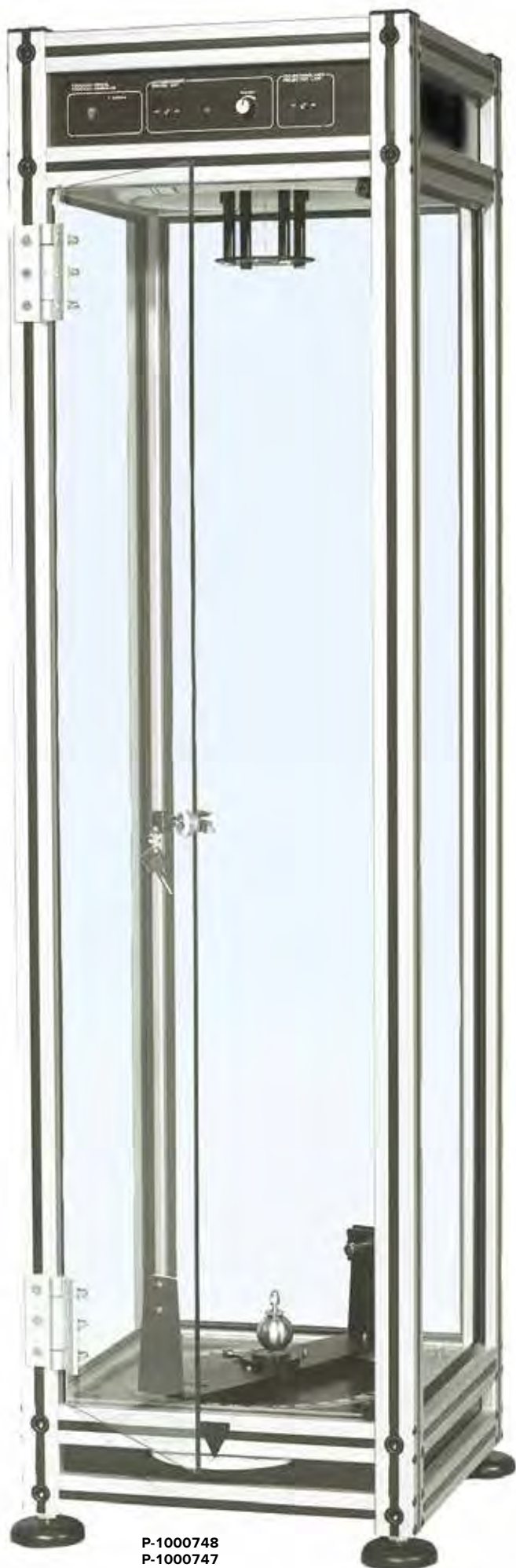

P-1000748
P-1000747

Experiment Topics:

- Pendulum oscillations
- Rotation of the Earth
- Coriolis force

Foucault Pendulum

Pendulum for qualitative and quantitative demonstration of the rotation of the earth by means of observing the plane of oscillation. To prevent the oscillation taking an elliptical path, the thread upon which the pendulum bob is suspended passes through a Charron ring. The plane of the oscillation is detected with high accuracy by projecting the shadow of the thread onto a protractor scale. The rotation of the plane can thus be identified in a very short period of time. For longer periods of observation, the gradual damping of the oscillation can be compensated for by means of an electromagnetic boost that can be adjusted to an arbitrary value. The apparatus is presented in decorative fashion inside a box with all sides made of and lit from the inside to make for a very eye-catching appearance.

Length of pendulum: 1200 mm

Mass of pendulum: 230 g

Diameter: 38 mm

Vertical alignment: By means of four height-adjustable feet

Angular resolution: 0.1°

Dimensions: 400x400x1400 mm³

Mass: approx. 40 kg

Foucault Pendulum (230 V, 50/60 Hz)

P-1000748

Foucault Pendulum (115 V, 50/60 Hz)

P-1000747



UE1050250

PDF online

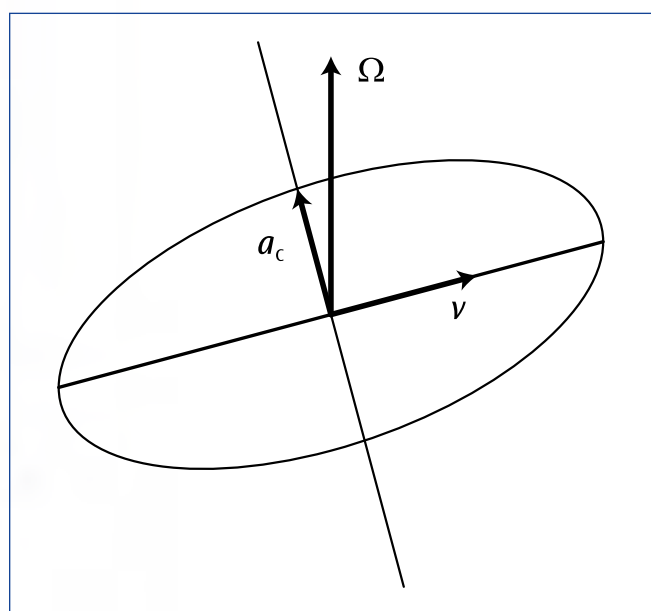

Diagram of Coriolis acceleration

Experiment Topics:

- Free rotary oscillations at various degrees of damping (oscillations with moderate damping, aperiodic oscillations and aperiodic borderline case)
- Forced oscillations and their resonance curves at various degrees of damping
- Phase displacement between the exciter and resonator during resonance
- Chaotic rotary oscillations

Plug-in Power Supply 24 V, 0.7 A

Plug-in power supply for the electric motor used with Pohl's pendulum (P-1002956). Including cables and two safety plugs on the secondary side.

Output voltage: 24 V, 0.7 A
Length of cables: 1 m

Plug-in Power Supply 24 V, 0.7 A (230 V, 50/60 Hz)

P-1000681

Plug-in Power Supply 24 V, 0.7 A (115V, 50/60 Hz)

P-1000680

Pohl's Torsion Pendulum

For investigating free, forced and chaotic oscillations at various degrees of damping. With slotted scale ring and pointers on resonator and exciter. An electric motor is included for exciting forced oscillations. It features coarse and fine speed adjustment and is coupled via an eccentric wheel. For damping, an electromagnetic eddy brake is used. The equipment can also be used in demonstrations involving projection of shadows.

Natural frequency: approx. 0.5 Hz
Excitation frequency: 0 to 1.3 Hz
Connectors: 4-mm safety sockets
Motor: max. 24 V AC/DC, 0.7 A
Eddy brake: 0 – 2 A DC, 20 V
Scale ring: 300 mm diam.
Dimensions: 400x140x270 mm³
Weight: 4 kg

P-1002956

Additionally required:

P-1003312 DC Power Supply 0 – 20 V, 0 – 5 A (230 V, 50/60 Hz)

P-1000681 Plug-in Power Supply 24 V, 0.7 A (230 V, 50/60 Hz)

or

P-1003311 DC Power Supply 0 – 20 V, 0 – 5 A (115 V, 50/60 Hz)

P-1000680 Plug-in Power Supply 24 V, 0.7 A (115 V, 50/60 Hz)

P-1003369 Stopwatch, 15 min

P-1003073 Analogue Multimeter AM50

Patch Cords

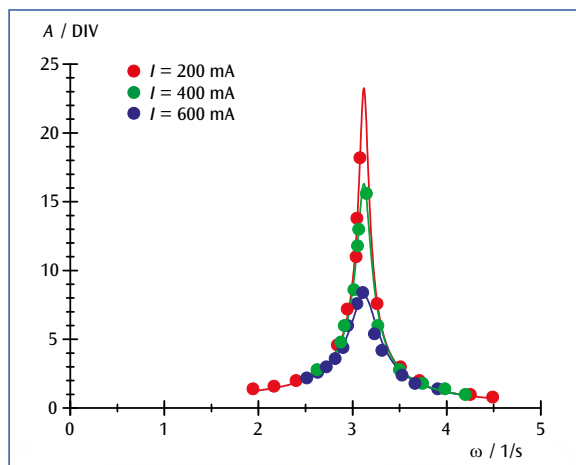

Resonance curve for different degrees of damping



UE1050500
UE1050550
PDF online

P-1002956

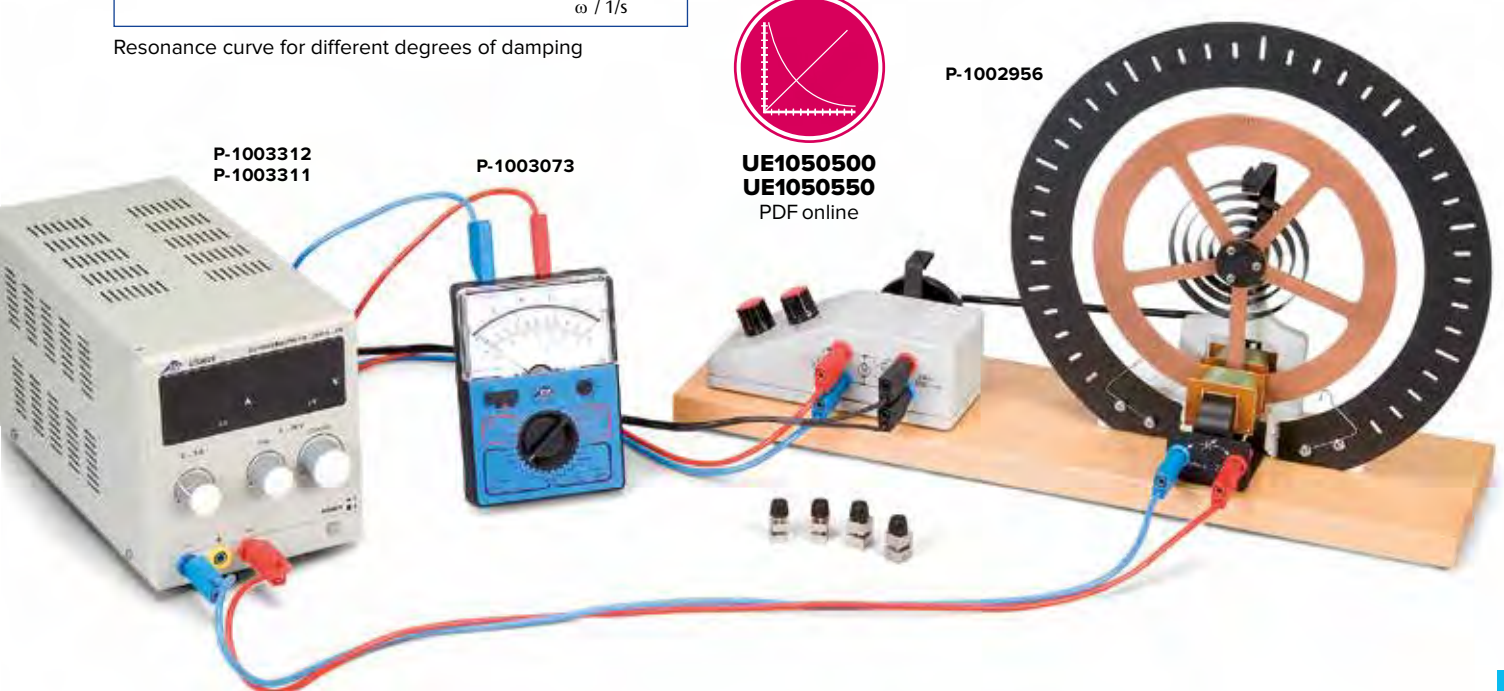

Experiment Topics:

- Rotary oscillations
- Determination of moments of inertia using the oscillation method
- Moments of inertia of various geometric bodies
- Steiner's theorem



P-1008662

Torsion Axle

Robust axle for investigating rotational oscillation of various test bodies and for determining their moments of inertia from the period of oscillation. With ball-bearing mounted shaft, high-quality coil spring and holding lug. Tests are undertaken on weights, which can be moved along a thin transverse rod. A circular disc, which can be used for determining moments of inertia for eccentric axes of rotation and confirming Steiner's theorem is included.

Deflecting torque

of the spring: 0.028 Nm/rad.

Height of the

torsional axle: approx. 200 mm

Transverse rod:

Length: 620 mm

Weight: 135 g

Weights: 260 g each

Disc:

Diameter: 320 mm

Weight: 495 g

Boreholes: 8

Borehole spacing: 20 mm

P-1008662

Additionally required:

P-1002836 Stand Base Tripod, 185 mm

Additionally recommended:

P-1002811 Digital Stopwatch

P-1003104 Precision Dynamometer 1 N

P-1008663 Set of Test Bodies for Torsion Axle

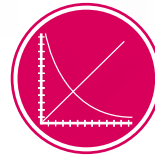

UE1040205
PDF online



P-1008663

Set of Test Bodies for Torsion Axle

Accessories for the torsion axle (P-1008662) used to demonstrate how moment of inertia depends on the distribution of weight around the axis of rotation. Consisting of two cylinders with nearly identical weights but different weight distributions, a mounting plate for the cylinders, a wooden disc and a wooden sphere.

P-1008663

Hollow cylinder (metal):

External diameter: 90 mm
Height: 90 mm
Weight: approx. 425 g

Solid cylinder (wood):

Diameter: 90 mm
Height: 90 mm
Weight: approx. 425 g

Mounting plate:

Diameter: 100 mm
Weight: approx. 122 g

Wooden disc:

Diameter: 220 mm
Height: 15 mm
Weight: approx. 425 g
Moment of inertia: 0.51 kgm²

Wooden sphere:

Diameter: 146 mm
Weight: approx. 1190 g
Moment of inertia: 0.51 kgm²

Device for Archimedes' Principle

For demonstrating Archimedes' principle of buoyancy in liquids. Consists of a hollow cylinder with a stirrup and hook, as well as a precisely fitted solid cylinder with an eyelet.

Diameter: 55 mm
Height: 53 mm

P-1003378



P-1003378



P-1018834

For demonstrating Archimedes' principle for buoyancy in liquids



P-1018836

P-1018835

Metal Bridge

Accessory for hydrostatic experiments with beam balance (P-1018834).

P-1018835



P-1000768

Set of 5 density bodies

Set comprising five rectangular prisms made of various materials and a transparent block with a hollow body, all with the same dimensions for demonstrating Archimedes' principle. The bodies have 2-mm bores by which they can be suspended.

Materials: Wood, aluminium, iron, brass, copper
Dimensions of each body: 10x20x45 mm³

P-1000768

Additionally required:

P-1003104 Precision Dynamometer 1N

Cartesian Diver

For demonstrating a body floating, sinking or rising in water. A hollow figure made of coloured glass, with a narrow opening. The figure floats upright in a cylinder filled with water and can be made to float, sink or rise by applying pressure to the rubber cap. The rubber cap fits cylinder diameters of approx. 30 mm to 40 mm, e.g. free-standing cylinder (P-1002871).

Contents:

- 1 Cartesian diver
- 1 Rubber cap

P-1002867

Additionally required:

P-1002871 Free-Standing Cylinder, without Graduation



P-1002867

Buoyancy

Archimedes' Beaker

Beaker with stirrup and hook including snug-fitting cylinder with eyelet for the verification of Archimedes' principle.

Diameter: 30 mm
Height: 78 mm

P-1018836

Additionally recommended:

P-1018834 Beam Balance

P-1018835 Metal Bridge

Buoyancy Apparatus

Apparatus for demonstrating buoyancy of fluids, consisting of a flat ground glass tube and a plastic disc with rubber covering to form a base plate to which a long string is attached. The base plate makes a watertight connection with the glass tube and when both are immersed in water, the plate does not sink because buoyancy keeps it pushed up against the tube.

Glass tube: 200 mm x 28 mm diam.
Metal disc: 2 mm x 42 mm diam.
Length of string: 35 cm

P-1000791

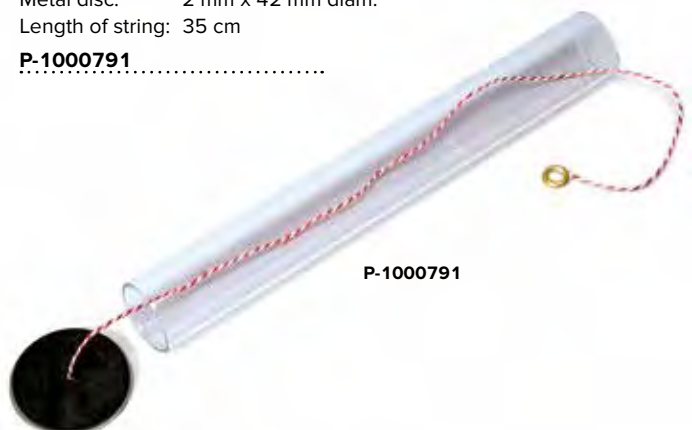

P-1000791

Mechanics

Set of 3 Cylinders, Equal in Volume

Set of three cylinders of equal volume and unequal mass each with a hook.

Materials: Aluminium, iron, brass

Dimensions of cylinders: 40 mm x 20 mm diam. approx.

P-1000752

Additionally recommended:

P-1003429 Electronic Scales 600 g (230 V, 50/60 Hz)

P-1002870 Graduated Cylinder, 100 ml

**Density Paradox Set**

Two identical plastic cylinders with a density close to that of water. If the first is immersed in hot water, it will initially sink but will then float up to the surface after a short time. If the second one is then put into ice-cold water, it will initially float but will then sink to the bottom. The reason for this is that the density of the plastic changes more than that of the water when it is heated or cooled.

P-1003498

Additionally recommended:

2 Beakers from P-1002872

Set of 3 Cylinders, Equal in Mass

Set of three cylinders of equal mass and unequal volume each with a hook.

Materials: Aluminium, iron, brass

Mass of cylinders: 100 g

P-1000754

Additionally recommended:

P-1003429 Electronic Scales 600 g (230 V, 50/60 Hz)

P-1002870 Graduated Cylinder, 100 ml

Immersion Blocks

Immersible body of known volume with hook. Can be used in conjunction with scales to determine the density of solid bodies and with a dynamometer for determining buoyancy.

Art. No.	Description
P-1002952	Al, 50 cm ³
P-1002953	Al, 100 cm ³
P-1002954	Fe, 50 cm ³
P-1002955	Fe, 100 cm ³

Additionally recommended:

P-1003429 Electronic Scales 600 g (230 V, 50/60 Hz)

or

P-1003107 Precision Dynamometer 10 N

Alcohol Meter

Gay-Lussac alcohol meter for determining the alcohol content in percentage by volume of ethanol/water mixtures at a reference temperature of 15°C. Without thermometer, in storage container.

Scale: 0 to 100% vol

Division: 1%

Length: 260 mm

P-1002875

Universal Areometer

Areometer for determining the density of liquids in g/ml at a reference temperature of 20°C. Without thermometer, in storage container.

Measuring range: 0.7 – 2 g/ml

Scale division: 0.02 g/ml

Length: 310 mm

P-1002876

Gay-Lussac Pycnometer

Glass body with ground capillary stopper for determining the density of liquids.

Volume: 50 ml

P-1002874

**Set of 3 Areometers**

Set of areometers for determining the density of liquids in g/ml at a reference temperature of 20°C / 68°F. Without thermometer, in storage container.

P-1003012

Measuring range	Scale division	Length
0.650 – 1.000 g/ml	0.005 g/ml	315 mm
1.000 – 1.500 g/ml	0.005 g/ml	235 mm
1.500 – 2.000 g/ml	0.005 g/ml	235 mm

Pressure Container for Determining Weight of Air

Airtight metal can with valve for demonstrating weight of compressed air. With bicycle valve for pumping in air. The weight of the air pumped in is determined by weighing and the volume can be determined by gauging the capacity.

Dimensions: 60x190 mm² approx.

Weight: 100 g approx.

P-1000796

Additionally required:

P-1003428 Electronic Scales 400 g (230 V, 50/60 Hz)

Bicycle Pump

Set of 7 Cubes for Determining Density

Set of seven cubes made of various materials for determining densities by weighing. Supplied in a storage case.

Materials: Wood, plastic, aluminium, iron, copper, brass, zinc

Side of cubes: 10 mm

P-1000766

Additionally required:

P-1003429 Electronic Scales 600 g (230 V, 50/60 Hz)



Set of 2 Materials with 4 Different Masses Each

Two sets of test bodies made of the same material but with four different masses for deriving the concept of density in school experiments. Supplied in storage containers.

Materials: Aluminium, PVC

P-1003499

Additionally recommended:

P-1003429 Electronic Scales 600 g (230 V, 50/60 Hz)

P-1002870 Graduated Cylinder, 100 ml

Sphere for Weighing Gases 1000 ml

Glass sphere with two taps and nozzles for attaching tubing for demonstrating the weight of air from the difference in weight between the sphere when filled with air and when evacuated.

Weight: 200 g approx.

P-1003519

Additionally recommended:

P-1003428 Electronic Scales 400 g (230 V, 50/60 Hz)

P-1012856 Vacuum Hand Pump

P-1003499

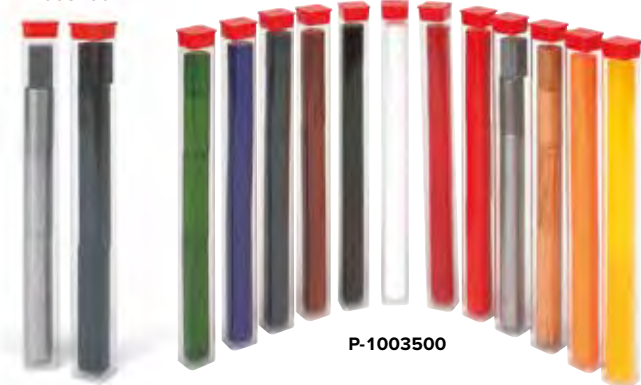

P-1003500

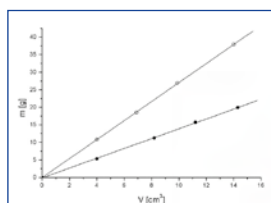

Determining the density of aluminium and PVC

P-1003501

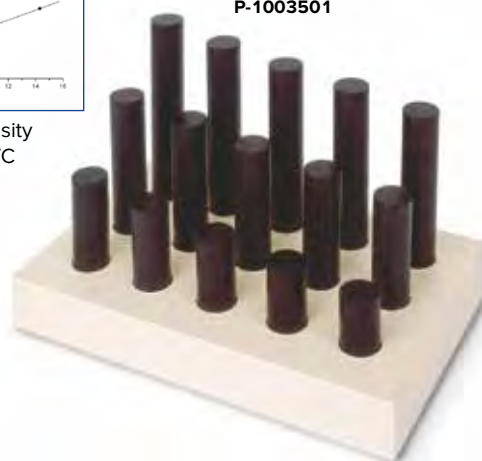

Set of 12 Materials with 4 Different Masses Each

Twelve sets of test bodies made of the same material but with four different masses for deriving the concept of density in school experiments. Supplied in storage containers.

Materials: Wood, polypropylene, polyamide, acrylic (2 colours), polyurethane, phenol, PVC (3 colours), Teflon and aluminium

Densities: 0.71 – 2.71 g/m³

Dimensions: 25 / 35 / 50 / 70 mm x 16 mm diam. approx.

P-1003500

Additionally recommended:

P-1003429 Electronic Scales 600 g (230 V, 50/60 Hz)

P-1002870 Graduated Cylinder, 100 ml

Set of 15 Bodies with 2 Different Densities

Set of 15 test bodies of various masses made of two identical looking materials for deriving the concept of density in experiments at school. Supplied on a storage tray.

Materials: Plastic of density 1.41 g/cm³ and 1.15 g/cm³

P-1003501

Additionally recommended:

P-1003429 Electronic Scales 600 g (230 V, 50/60 Hz)

P-1002870 Graduated Cylinder, 100 ml



Pascal's Vane Apparatus

For demonstrating the hydrostatic paradox and for quantitative measurements of ground pressure. This pressure is measured through the curvature of a membrane and indicated in magnified form with the help of a lever multiplier. Compensation for comparative measurements is possible. Includes four differently shaped vessels made of glass.

- Height of the vessels: 220 mm
- Tube diameter at the bottom: 22 mm
- Total height: 350 mm
- Base-plate area: 260x110 mm²
- Weight: 0.8 kg

P-1002957

Hydraulic/Pneumatic Lifting Platform

Complete equipment set for demonstration and practical training such as investigating transmission of hydraulic or pneumatic force, the relationship between force, surface area and pressure as well as verification of Boyle's law. A rugged stand holds a cylinder with piston (60 cm³ volume). The lifting platform is positioned on the piston. Various levels of pressure can be exerted on the piston using a system of tubing with 3 simple hand pumps of different volumes. A hose fitting for connection of a pressure sensor required to record measured values with a datalogger is also included.

- Dimensions: approx. 140 mm diam. x 190 mm
- Pump volumes: 3 cm³, 6 cm³, 20 cm³

P-1003495

Pressure Balance

Introducing the concept of pressure, for comparing pressures, for gas-compression experiments and for demonstrating overpressure and underpressure. Two precision glass syringes of different volumes with ground piston and weight pans on stand. Includes 15 disc weights on a storage rod for adding to plunger. Connection between the syringe hoses via a tubing clamp, safety catch for the smaller piston.

- Volume of syringes: 10 ml and 50 ml
- Ratio of piston cross-sections: 10:3
- Ratio of piston masses with weight pans: 10:3
- Mass of weights: approx. 400 mN each
- Baseplate dimensions: approx. 140x100 mm²

P-1002653

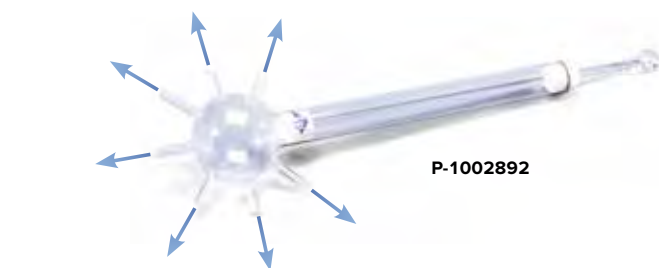

Pascal's Pressure Sphere

Glass vessel with movable plungers for demonstrating equal distribution of pressure in all directions, observed by means of water jets forced out under pressure.

- Total length: 350 mm
- Diameter: approx. 70 mm

P-1002892

U-Shaped Manometer D

Demonstration manometer for measuring pressure in centimetres of water. The manometer consists of a U-tube open at both ends attached to a fibre-board (MDF) featuring a scale.

- Length of each leg: 50 cm
- Measuring range: 0 – 50 cm of water or 0 to 5 kPa
- Tubing diameter: 10 mm
- Dimensions: 200x150x530 mm³ approx.
- Weight: 820 g approx.

P-1009714

Additionally recommended:
P-1000793 Indigo Solution

P-1009714



U-tube Manometer S

Manometer for measuring pressures in the range 0 to 10 hPa (cm water column). U-tube open on both sides with overflow basin on aluminium base plate with scale. Includes stand rod on the reverse for attaching to stand base.

- Length of arms: 200 mm
- Stand rod: 33 mm x 10 mm diam.
- Base plate: 210x70 mm² approx.
- Weight: 80 g approx.

P-1000792

Additionally required:
P-1000793 Indigo Solution

Additionally recommended:
P-1002622 Silicon Tube, 1 m

P-1000792



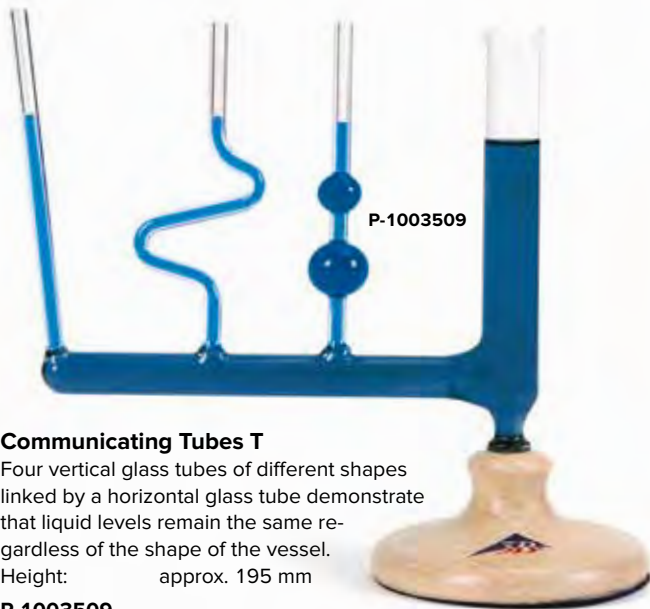

Communicating Tubes T

Four vertical glass tubes of different shapes linked by a horizontal glass tube demonstrate that liquid levels remain the same regardless of the shape of the vessel.
Height: approx. 195 mm

P-1003509

Surface Tension Ring

Aluminium ring with a blade for determining the surface tension of liquids. Includes a hook and three threads for suspension from a dynamometer.

Diameter: 60 mm
Weight: 5 g approx.

P-1000797

Additionally required:

- P-1002941 Laboratory Jack**
- P-1003102 Dynamometer 0.1 N**
- P-1002872 Beaker, 600 ml**
- Stand equipment**

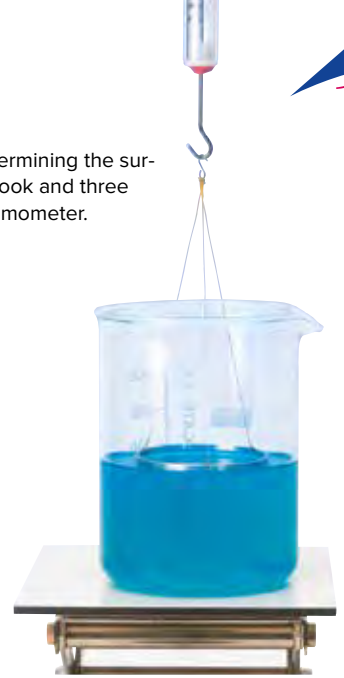

P-1000797



Glass Cylinder with 2 Tubes

Glass vessel for demonstrating communicating tubes. Consists of a glass cylinder with two openings and GL screw connections, as well as two differently shaped glass tubes.

Height: approx. 220 mm

P-1002891



P-1003510

Apparatus for Investigation of Capillary Effects

A horizontal glass tube can be connected to a water reservoir through capillary tubes of different diameters. The smaller the diameter of the capillary tube, the higher the water climbs above the level of the reservoir due to the greater hydrostatic pressure.

Internal diameters of the capillary tubes: 2.0 mm, 1.5 mm, 1.0 mm and 0.5 mm
Height: 165 mm approx.

P-1003510

Outlet Vessel, Metal

Robust metal cylinder with three outlets at various heights for the purpose of investigating hydrostatic pressure due to depth of water by observing the jets of water emerging from the outlets under pressure.

Height: 430 mm approx.
Diameter: 125 mm approx.

P-1009715



P-1009715

Indigo Solution (not shown)

30 ml indigo solution in a flask, for colouring water in demonstration experiments.

P-1000793



P-1000794

Wedge Shaped Vessel

Wedge shaped vessel made of transparent acrylic for demonstrating the surface tension of liquids and capillary forces.

Length: 100 mm

P-1000794

Viscosity measurements using the following substances

- Light oils, machine oils, petroleum, petroleum ether, diesel (mineral oils and fuels)
- Plastic solutions, resin solutions, adhesive solutions, latex dispersions (polymer chemicals)
- Printers' ink, varnish, water-based paints, inks (inks and paints)
- Emulsions, suspensions, solutions, extracts (cosmetics/pharmaceuticals)
- Emulsions, dispersions (paper industry)
- Liquid detergents, washing-up liquid, surfactant solutions (detergents)
- Honey, fruit juice, beer, milk (food industry)
- Gases and mixtures of gases

Falling Sphere Viscometer

Höppler-type falling sphere viscometer for simple but accurate measurement of dynamic viscosity of transparent Newtonian fluids. The sphere rolls and slides inside an inclined cylindrical tube filled with the fluid to be tested. The viscosity is measured in $\text{mPa} \cdot \text{s}$ and is derived directly from the time the sphere takes to fall a specified distance through the fluid in the measuring tube. The tube can then be turned upside-down so that time the sphere takes to fall back can also be measured. The tube is situated inside a water bath, which can be filled with water at a specific temperature in order to measure how viscosity depends on temperature.

Includes:

Falling sphere viscometer with 6 spheres and 1 ball gauge
 Thermometer 0 – 100° C
 Cleaning set
 Test certificate with accurate values for sphere constant K and density ρ for converting duration of fall to actual viscosity.

Technical data

Measuring range:	0.5 $\text{mPa} \cdot \text{s}$ to $7 \cdot 10^4 \text{ mPa} \cdot \text{s}$ (as per DIN 53015) > $7 \cdot 10^4 \text{ mPa} \cdot \text{s}$ (for sphere fall times > 300 s)
Measurement precision	0.5 to 2% (depending on spheres used)
Spheres:	#1, #2: Borosilicate glass #3, #4: Ni-iron #5, #6: Steel
Diameter of spheres:	11.00 to 15.81 mm
Diameter of measuring tube:	15.95 mm
Fall times for spheres	30 to 450 s
Length of measured distance:	100 mm in both directions
Operating angle:	10° to vertical
Additional working angles	70°, 60°, 50° to horizontal
Volume when full:	40 ml
Permissible temperature range:	-60°C to +150°C
Dimensions:	180x220x330 mm
Weight:	3.1 kg

P-1012827

Additionally required:

P-1002811 Digital Stopwatch

Additionally recommended:

P-1002622 Silicone Tubing (2x)

P-1008654 Immersion/Circulation Thermostat (230 V, 50/60 Hz)

or

P-1008653 Immersion/Circulation Thermostat (115 V, 50/60 Hz)

Glycerine

250 ml of glycerine in aqueous solution for experiments on viscosity. In glass bottle
 Concentration: 85%

P-1007027



P-1007027

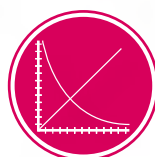

UE1080350
PDF online



P-1008654
P-1008653



P-1012827

new

Experiment Topics:

- Elastic deformation of flat bars
- Determining modulus of elasticity

Advantages

- Load characteristics of the strain gauge may be ignored
- Measurements can be set up with the material samples supported on both sides or clamped at one end

Apparatus for Measuring Young's Modulus

Measuring apparatus for investigating the elastic deformation of rods of flat geometry and for determining the modulus of elasticity. Features a strain gauge unit for determining the deformation of electrically conducting material samples. The strain gauge unit is electrically connected to the material sample in such a way that placing of the probes on the sample is determined with a high degree of sensitivity and displayed with the help of two LEDs. The bending of the material sample with the weight suspended is measured to an accuracy of 0.01 mm and the modulus of elasticity can then be calculated from the reading.

Battery for strain gauge unit: 9 V, 6F22
 Dimensions: 550x280x500 mm³
 Weight: 5.5 kg approx.

Contents:

- 6 Flat steel rods (w: 15 mm, l: 200 / 300 / 400 mm, thickness: 2 / 3 mm)
- 1 Strain gauge unit
- 1 Horizontal beam with stand
- 2 Knife-edge bearings
- 1 Clamping chuck
- 1 Set of weights and retaining clamps

P-1018527

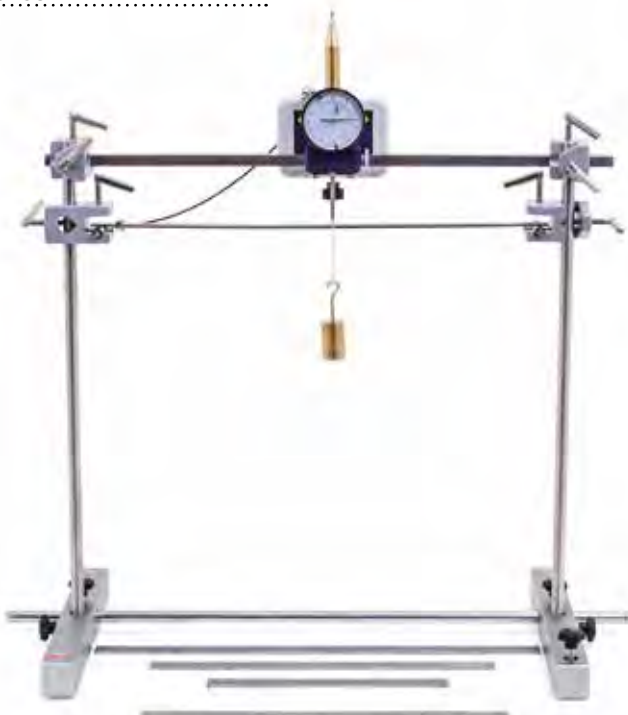

P-1018527

Young's Modulus Supplementary Set (not shown)

Set of flat bars with the effective lengths of 200, 300 and 400 mm and the widths of 10 and 20 mm for measurement of elastic deformation and modulus of elasticity using the modulus of elasticity equipment set (P-1018527).

Contents:

- 12 Flat bars made of steel (thickness: 2 / 3 mm)
- 6 Flat bars made of aluminium (thickness: 3 mm)

P-1018528

new

Experiment Topics:

- Torsion on cylindrical bars
- Determining the shear modulus

Advantages

- Simple set-up and operation
- Static and dynamic measurements possible without time-consuming reconfiguration

Torsion Apparatus

Measurement apparatus for investigating torsion as applied to bars with cylindrical geometry and to determine both directivity values and shear modulus. With a scaled disc for torsion angle measurement and a pendulum disc for transmission of torsional forces to the clamped material samples in the case of static measurements as well as for the determining moment of inertia in the case of dynamic measurements. The period of oscillation is measured electronically in the dynamic case using a light barrier. The approximate variables and the shearing modulus are derived from the measurements.

Dimensions: 570x300x300 mm
 Weight: 2.3 kg approx.

Contents:

- 1 Cylindrical bar made of steel (d: 2 mm, l: 500 mm)
- 1 Basic unit of torsion apparatus
- 1 Base plate for light barrier (P-1000563)

P-1018550

Additionally required:

- P-1003370 **Dynamometer, Colour-Coded, 2.5 N**
 - P-1003371 **Dynamometer, Colour-Coded, 5 N**
 - P-1000563 **Light Barrier**
 - P-1001033 **Digital Counter (230 V, 50/60 Hz)**
- or
- P-1001032 **Digital Counter (115 V, 50/60 Hz)**

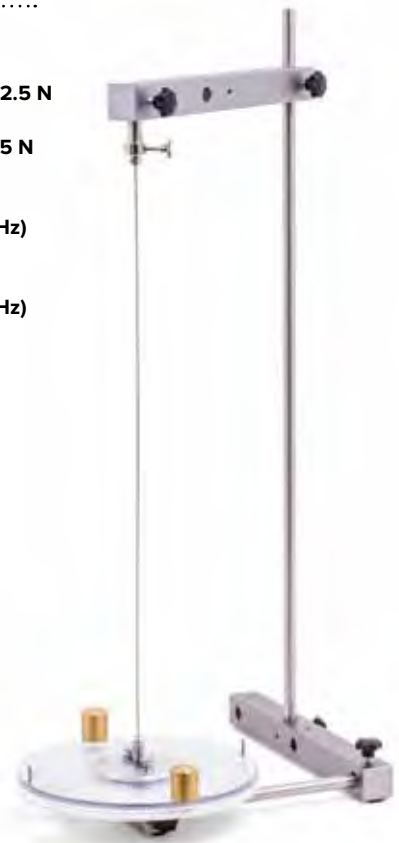

P-1018550

Supplementary Set for Torsion Apparatus (not shown)

Set of round bars for measuring torsion, directivity and shearing modulus with the torsion apparatus (P-1018550).

Contents:

- 1 Cylindrical bar made of steel (d: 2 mm, l: 300 mm)
- 6 Cylindrical bars made of brass / copper / aluminium / (d: 2 mm, l: 300 / 500 mm)
- 2 Cylindrical bars made of aluminium (d: 3 / 4 mm, l: 500 mm)

P-1018787



P-1010126

Vacuum Chamber with Hand Pump

Inexpensive, transparent plastic vacuum chamber for basic experiments with low pressure. Hand pump integrated into base plate, bleed valve and manometer for measuring pressure down to 330 hPa.

Dimensions: Ø 200 mm, H = 250 mm approx.

P-1010126

Additionally required:
P-1010125 Set of 100 Balloons

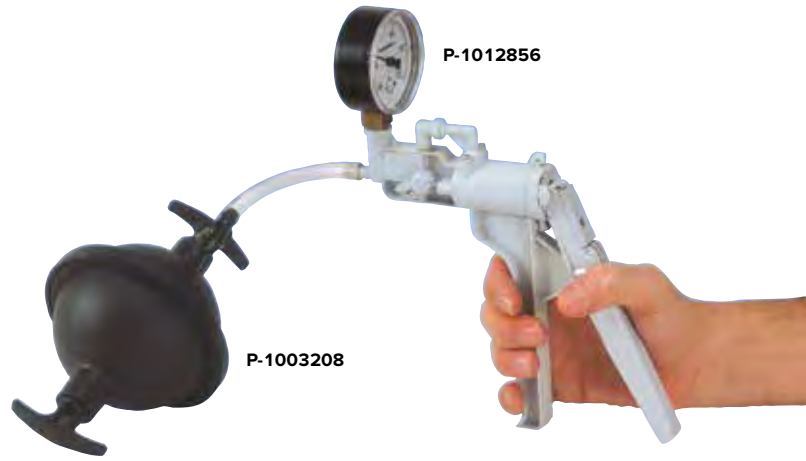

P-1003208

P-1012856

Magdeburg Hemispheres

To demonstrate Von Guericke's historical experiment on the effect of atmospheric air pressure. Two plastic hemispheres equipped with handles can be joined vacuum-tight using the insertable rubber sealing ring. One hemisphere is equipped with a stopcock and hose connection. Including air hose.

Vacuum connection: 8 mm
Diameter: 120 mm
Hose length: 110 mm

P-1003208

Additionally required:
P-1012856 Vacuum Hand Pump



P-1003496

Magdeburg Plates

Equipment set for demonstrations and practical teaching of Guericke's historical experiment investigating the effect of atmospheric pressure. Includes nozzle for tubing, a simple hand pump and tubing with built-in directional valves. Two transparent acrylic plates with handles that can be held together with a coarse vacuum between them. Three sealing rings of various sizes are supplied for sealing the plates. This allows the dependency of the force on the contact area to be investigated.

Acrylic plates: approx. 13x105 mm diam.
Sealing rings: approx. 65 mm, 80 mm, 100 mm diam.

P-1003496



P-1010125

Set of 100 balloons

Set of 100 balloons for use in vacuum chamber with hand pump.

P-1010125

Vacuum Bell Jar

Vacuum bell jar made of glass with grip knob and polished flange to be set on top of the vacuum experiment plate (P-1003166).

Inner diameter: 190 mm
Total height: 220 mm

P-1003167



Vacuum Experiment Plate

Experiment plate for the assembly of a vacuum chamber in conjunction with the vacuum bell jar (P-1003167) for experiments in the coarse and fine vacuum range. Metal plate with sealing ring on a tripod, hose connection of the pump-side and ventilation cock. Includes two-pole current feed via 4-mm safety sockets and cable of approximately 1 m length with 4 mm safety plugs, plus a central bore with M12 thread for attaching experimental equipment.

Diameter: 250 mm
Height: 90 mm
Electrical limit specs.: max. 48 V, max. 12 A
Vacuum connection: 2 hose nozzles 12 mm and 8 mm diam.

P-1003166

Additionally required:
P-1003167 Vacuum Bell Jar
P-1003317 Rotary-Vane Vacuum Pump, Two-Stage
P-1002619 Vacuum Hose 8 mm

Vacuum Recipient

Inexpensive vacuum recipient made of transparent acrylic for experiments in coarse and fine vacuums. Comprises a base and vacuum cylinder with venting valve, manometer, inlet tap, entrance for contacts and rubber ring.

Volume: 9 l approx.
Leakage rate: < 0.5 mbars/h
Base plate: 320x320x10 mm approx.
Vacuum cylinder: 200 mm x 240 mm (diam.) approx.
Thickness of walls: 5 mm
Weight: 2.9 kg approx.

P-1009943

Additionally required:
P-1012831 Vacuum Tubing, 4 mm
P-1003317 Rotary-Vane Vacuum Pump, Two-Stage

P-1009943



Electric Doorbell

Bell for demonstrating electro-magnetic operation of apparatus and verifying that sound waves do not propagate in a fine vacuum (< 1 hPa). Open acrylic housing with 4-mm safety sockets.

Power supply: 6 V AC
Dimensions: 100x95x50 mm³

P-1003170

Additionally required:
Vacuum Chamber
Vacuum Pump
P-1003316 Transformer with Rectifier 3/ 6/ 9/ 12 V, 3 A (230 V, 50/60 Hz)
or
P-1003315 Transformer with Rectifier 3/ 6/ 9/ 12 V, 3 A (115 V, 50/60 Hz)

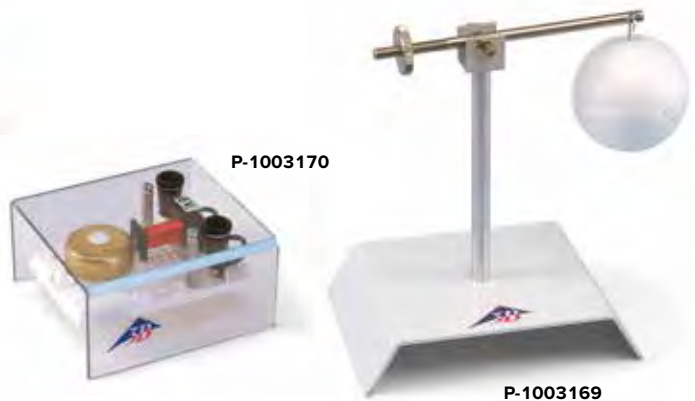

Baroscope

Beam balance on base with suspended polystyrene ball and adjustable counterweight for demonstrating buoyancy on a body due to atmospheric pressure. At a state of equilibrium a Baroscope is placed in a vacuum bell jar under atmospheric pressure. The air in the bell jar is then evacuated, the Styrofoam sphere falls on account of the reduction in lift.

Styrofoam sphere: 50 mm diam.
Base: 120x90 mm²
Height: 125 mm

P-1003169

Additionally required:
Vacuum Chamber
Vacuum Pump



Vacuum Hoses

Vacuum hoses made of natural rubber according to DIN 12865. Colour red.

	P-1012831	P-1012830	P-1002619	P-1002620
Length	1 m	1 m	1 m	1 m
Internal diameter	4 mm	6 mm	8 mm	10 mm
Wall strength	4 mm	4 mm	5 mm	5 mm
Temperature range	-30° up to + 85°	-30° up to + 85°	-30° up to + 85°	-30° up to + 85°

Water-Jet Pump

Pump for experiments in a coarse vacuum; equipped with an integrated non-return valve to prevent water rise; can be disassembled.

Material: Plastic
 Suction capacity: approx. 4 l/min (dependent on water pressure)
 Final total pressure: approx. 15 hPa (dependent on water temperature)

Pump-out time for a 5 l container: 6 to 10 minutes
 Threaded joint: R 1/2" with inserts for R 3/8" and R 3/4"

P-1003008



P-1000798

Piston Vacuum Pump

Robust two-stroke piston pump for vacuum experiments, for final vacuum pressures down to 400 hPa. Air is pumped out on both the upward and the downward stroke of the piston. Includes carrying rod with handles and heavy base plus vacuum hose diam. 5 mm.

Final pressure: 400 hPa
 Tubing nozzle: 5 mm diam.
 Dimensions: approx. 160x235x560 mm³

Weight: approx. 1.7 kg

P-1000798

Vacuum Hand Pump

Simple mechanical air pump for filling and evacuating small containers; equipped with an ergonomic handle, a manometer with a pointer that rotates through a full 360°, a ventilation valve, two hoses (long and short) and six connecting adaptors.

Manometer: -980 hPa – 4000 hPa
 Tubing nozzle: 8.5 mm diam.
 Hose: 850 mm x 6.5 mm internal diam.
 65 mm x 4.5 mm internal diam.
 Dimensions: approx. 180x60x260 mm³
 Weight: approx. 0.3 kg

P-1012856



P-1012856

Rotary-Vane Vacuum Pump, One-Stage

High performance, compact, one-stage, oil-sealed rotary vane pump for vacuum experiments. With thermal overload protection, handle, air valve, manometer and hose nipple. Includes pump oil.

Suction capacity: 100 l/min
 Final pressure: 0.05 hPa
 Motor power: 245 W
 Manometer: 0 – 1000 hPa
 Hose nipple: 10 mm diam.
 Supply voltage: 115 V or 230 V, 50/60 Hz
 Dimensions: approx. 335x138x250 mm³
 Weight: approx. 8 kg

P-1012855

Rotary-Vane Vacuum Pump, Two-Stage

High performance, compact, two-stage, oil-sealed rotary vane pump for vacuum experiments. With thermal overload protection, handle, air valve, manometer and hose nipple. Includes pump oil.

Suction capacity: 100 l/min
 Final pressure: 0.003 hPa
 Motor power: 245 W
 Manometer: 0 – 1000 hPa
 Hose nipple: 10 mm diam.
 Supply voltage: 115 V or 230 V, 50/60 Hz
 Dimensions: approx. 335x138x250 mm³
 Weight: approx. 11 kg

P-1003317



P-1012855



P-1003317

Metering Valve, DN 16 KF

Adjustable using micrometer screw.

Connection: DN 16 KF

P-1018822



2-Way Ball Valve DN 16 KF

Connection: DN 16 KF
Length: 100 mm

P-1002923

Crosspiece DN 16 KF

Connection: DN 16 KF
Dimensions: 80x44 mm²

P-1002924

T-Piece DN 16 KF

Connection: DN 16 KF
Dimensions: 50x44 mm²

P-1002925

Rotary-Vane Vacuum Pump, P 4 Z

Compact, two-stage rotary pump with high suction capacity. Automatic lubrication of the rotary valve and ball bearings using optimized oil pressure increases the final pressure levels achievable, stabilizes the pump temperature and prolongs the pump's working life. Includes direct drive with elastic coupling. Device exhibits good resistance to chemicals and a high degree of water vapour compatibility. A suitable mechanism prevents the oil from rising back to contaminate the recipient. Lightweight device that operates with low noise. High-quality parts make the device capable of continuous operation. The pump is complete and ready for connection with a full complement of oil, centring ring, locking ring, motor protection circuit breaker, mains switch and connection cable with mains plug.

Connecting flange: DN 16 KF
Suction performance (Pneurop): 77/92 l/min at 50/60 Hz
Final pressure (without partial gas ballast): 2×10^{-4} hPa
Final pressure (with total gas ballast): 1×10^{-2} hPa
Water vapour tolerance: 40 hPa
Motor output: 200 W
Oil capacity: 530 ml
Supply voltage: 100 / 115 / 230 V, 50/60 Hz
Dimensions: 415x150x235 mm³ approx.
Weight: 17.5 kg approx.

P-1002919



P-1002919

Adaptor Flange DN 16 KF / Shaft 12 mm

Adaptor flange for connecting a vacuum hose to ISO-KF systems.
Connection: DN 16 KF
Tubing nozzle: 12 mm
Length: 40 mm

P-1002928

Adaptor Flange DN 16 KF / NS 19/26

Adaptor flange for connecting components with internally ground nozzles, e.g. gas discharge tube (P-1002905, to ISO-KF systems).

Connection: DN 16 KF
Core: 19/26 NS
Length: 40 mm

P-1002929

Ventilation Valve DN 16 KF

Connection: DN 16 KF
Dimensions: 36 mm x 26 mm diam.

P-1002926

Dummy Flange DN 16 KF

Connection: DN 16 KF

P-1002927

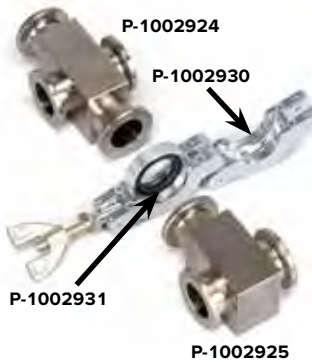

Tension Ring DN 10/16 KF

Tension ring for mechanically secure connection of ISO-KF components.
Connection: DN 16 KF

P-1002930

KF External Centring Ring DN 10/16 KF

Rubber sealing ring for ISO-KF connections.

P-1002931

Pirani Vacuum Gauge

An easily programmable desktop device for measurement and control in fine and coarse vacuums using a Pirani vacuum gauge. Includes a clearly arranged membrane keypad, measuring line (2.5 m) and mains cable.

Vacuum connection: DN 16 KF
Measuring range: 1100 – 0.001 hPa
Measurement uncertainty: < 20% of the display value
Display: Digital LED display in mbar, Pa, psi, torr
Digit height: 10 mm
Readout: 5 per s
Threshold switch: 2x 230 V, 2 A, independently adjustable
Switching accuracy/hysteresis: ± 1 digit
Permissible overload: 2 bar absolute
Power consumption: max. 15 W
Supply voltage: 100 / 115 / 230 V, 50/60 Hz
Dimensions: 90x120x90 mm³ approx.
Weight: 0.9 kg approx.

P-1012514



P-1012514

Jet Nozzle (Flow Laminator)

Nozzle for emitting a near laminar air stream, e.g. for experiments with the set of drag and lift objects or experiments on recoil. Mounted on a stem. The very light air nozzle contains no moving parts and generates no spin. It spreads out the air stream from a connected fan. Air that comes out of the tubular nozzles near the plastic ring mixes with the secondary air to form an overall air stream of a large diameter. Includes a hose.

Air inlet: 33 mm
 Air outlet: 120 mm
 Dimensions: 255x150 mm²
 Stand holder: 10 mm
 Weight: approx. 350 g

P-1000758

Additionally required:

P-1000606 Air Flow Generator (230 V, 50/60 Hz)

or

P-1000605 Air Flow Generator (115 V, 50/60 Hz)

Stand Equipment



Component Balance

Scales for measuring components with holding mechanism for measuring air resistance and buoyancy of bodies from set P-1000760. On rod.

Measuring range: 0 – 0.3 N
 Diameter of the scale: 170 mm
 Dimensions: approx. 350x220 mm²
 Rod diameter: 10 mm
 Weight: approx. 0.9 kg

P-1000761



P-1000758

P-1000761



P-1000760

Air Flow Generator

Fan allowing continuous adjustment of air flow. Includes a hose.

Hose length: approx. 1.5 m
 Power consumption: max. 1100 W
 Dimensions: 300x180x170 mm³
 Weight: 4.4 kg

Air Flow Generator (230 V, 50/60 Hz)

P-1000606

Air Flow Generator (115 V, 50/60 Hz)

P-1000605

Set of bodies for air resistance and buoyancy experiments

Set of 7 wooden models on stems for measuring buoyancy and fluid resistance of various bodies in laminar air flows. Including storage block.

Contents:

- 1 streamlined body, smooth, l = 120 mm
- 1 streamlined body, rough, l = 120 mm
- 1 ball, d = 50 mm
- 1 circular disc, d = 47 mm
- 1 circular disc, d = 68 mm
- 1 hemisphere, d = 50 mm
- 1 plate, 150 mmx40 mm
- 1 wing profile, l = 150 mm

P-1000760

Additionally required:

P-1000758 Jet Nozzle (Flow Laminator)

P-1000761 Component balance



P-1000606
 P-1000605

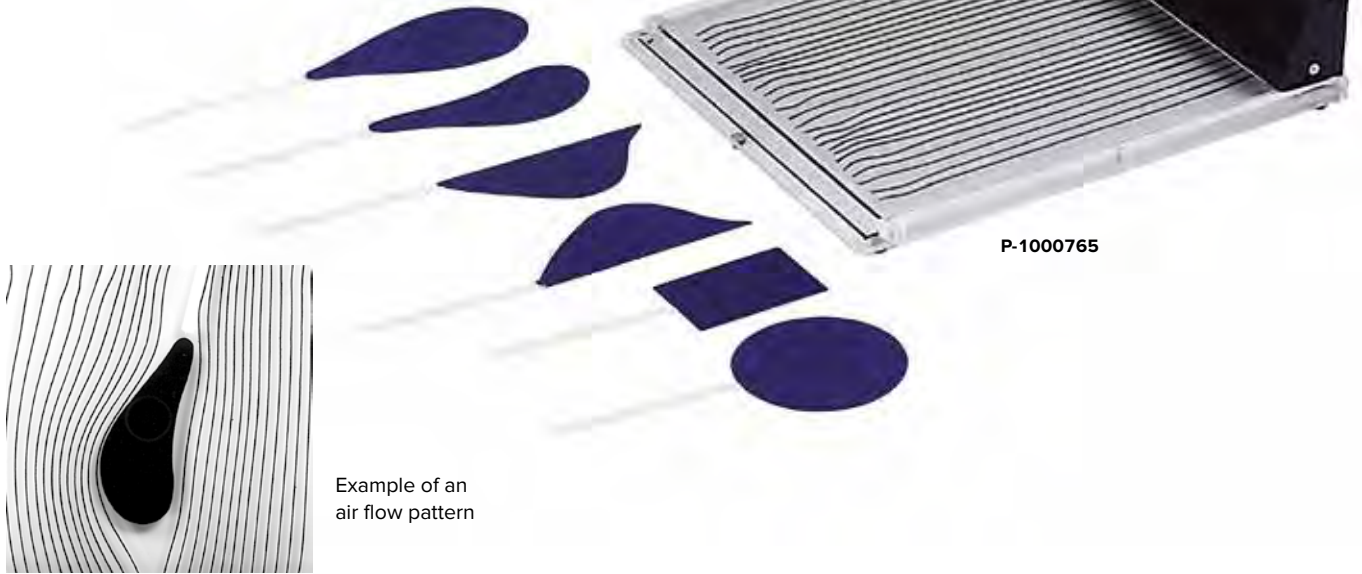

P-1000765

Example of an air flow pattern

Air Flow Apparatus

Apparatus for demonstrating air flow patterns around bodies of different shapes. The air flow patterns can be projected on to a wide screen using an overhead projector. Two strings are fastened on one side at equal distances between two glass plates. The strings move according to the air currents between the two glass plates. Bodies of different shapes can be introduced in the air current. The inserted bodies can be moved to various positions in the air current from outside. Includes a hose.

Dimensions: approx. 385x310x75 mm³
 Weight: approx. 3.2 kg

Contents:

- 1 Air flow apparatus
- 1 Circular body
- 1 Rectangular body
- 1 Streamlined body
- 1 Wing section
- 2 Bodies to demonstrate narrowing of flow
- 1 Hose

P-1000765

Additionally required:

- P-1000606 Air Flow Generator (230 V, 50/60 Hz)** or
- P-1000605 Air Flow Generator (115 V, 50/60 Hz)**

Additionally recommended:
Overhead Projector



P-1006784

Laminar Flow Apparatus

For demonstrating and investigating the laminar flow properties of water. The emergence of currents in water, the flow of current in the case of straight laminar flow and the overflow of differently shaped bodies can be studied. The flow of current at a narrows can also be demonstrated clearly. A rectangular piece of velour paper is placed in the apparatus consisting of an upper and lower trough. Owing to capillary forces, water from the upper trough is drawn in by the paper. The water flows down into the velour paper. The flow of water in the upper level is marked with a dye at constant intervals. Owing to the low speed of flow of approx. 2 mm/s, the development of currents can be observed with the help of the dye. After the velour paper has been dried, a lasting current pattern remains, which can be copied and evaluated.

Dimensions: approx. 220x140x240 mm³
 Weight: approx. 1 kg

P-1006784

Contents:

- 2 Acrylic glass basins
- 1 Mask
- 20 Sheets of velour paper with cut-outs
- 1 Mini-flask with dye
- Swab for dye
- Rubber gloves

Experiment Topics:

- Straight-line propagation of microwaves
- Reflection, absorption and transmission
- Shielding from microwaves
- Experiments on polarisation
- Experiments on diffraction
- Experiments on refraction and interference
- Transmission of information

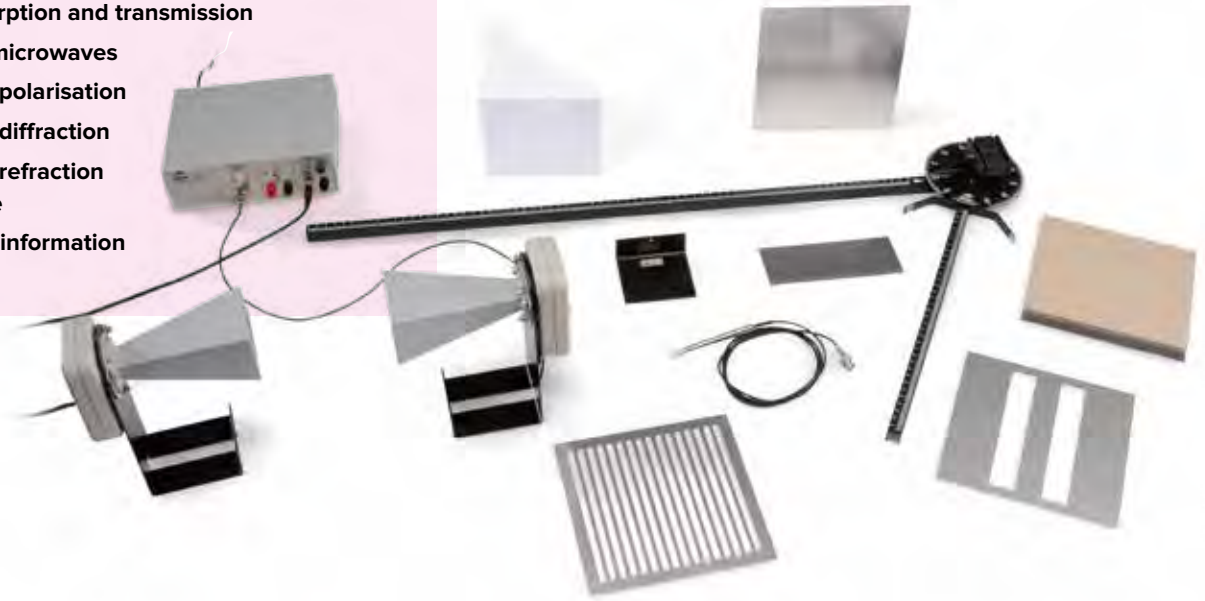

Microwave Set

Equipment set for conducting wave optics experiments involving wavelengths in the cm range. A transmitter with a horn antenna radiates a narrow beam of linearly polarised electromagnetic waves with a wavelength of about 3 cm. The direction of polarisation can be altered by rotating the antenna around the axis of propagation. To detect the waves, a horn antenna receiver and a microwave sensor are provided. A control unit converts the intensity of the signal received into a proportionally large output voltage that can be measured using a voltmeter. It is also possible to switch on an acoustic signal with a volume that is proportional to the intensity of the signal.

Oscillator frequency:	9.4 GHz (P-1009951)
	10.5 GHz (P-1009950)
Power of transmitter:	10 – 25 mW
Internal modulator frequency:	3 kHz approx.
Acoustic signal:	Switchable
External modulation:	100 Hz – 20 kHz, 1 V max.
Output voltage:	10 V max.
Receiver with horn antenna:	Silicon diode with resonator
Microwave sensor:	Silicon diode with resonator
Dimensions of basic apparatus:	approx. 160x200x75 mm ³

Contents:

- 1 Control unit
- 1 Plug in power supply
- 1 Transmitter with horn antenna
- 1 Receiver with horn antenna
- 1 Microwave probe
- 1 Microwave bench, 800 mm
- 1 Microwave bench, 400 mm with plate holder
- 1 Reflection plate 180x180 mm²
- 1 Polarisation grating, 180x180 mm²
- 1 Absorption plate, fibreboard, 180x180 mm²
- 1 Paraffin prism
- 1 Stand for prism
- 1 Plate with double slit
- 1 Cover plate for double slit

Microwave Set 9.4 GHz (230 V, 50/60 Hz)

P-1009951

Microwave Set 10.5 GHz (115 V, 50/60 Hz)

P-1009950

Additionally recommended:

P-1013526 Analogue Multimeter ESCOLA 30

Note:

Our recommendations for wave optics experiments using visible light can be found in the section "Light and optics".

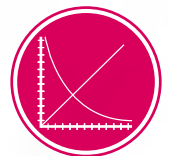

UE3060300
PDF online



Diffraction by a double slit



Paraffin Prism

Plastic prism filled with paraffin for use with microwave set (P-1009950 or P-1009951).

P-4008112

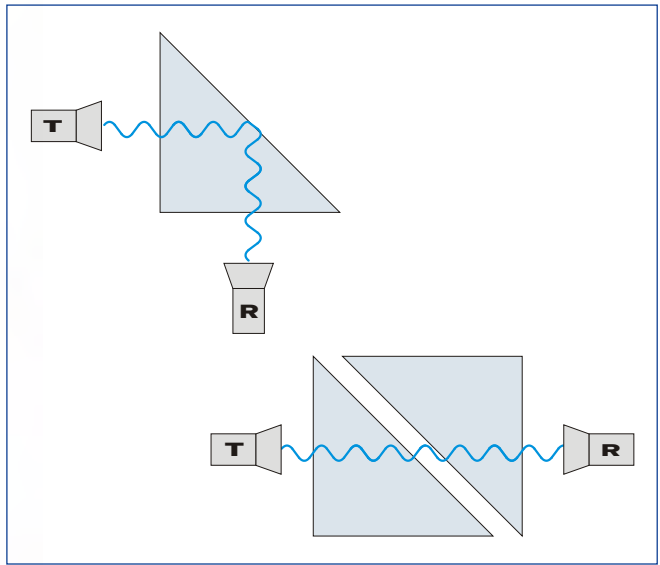

Schematic for tunnelling effect (T: Transmitter, R: Receiver)

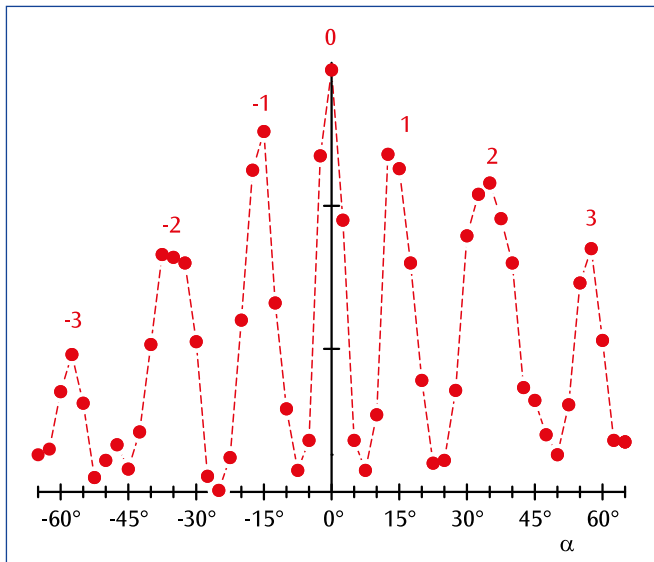

Intensity distribution resulting from the diffraction of microwaves at a pair of slits

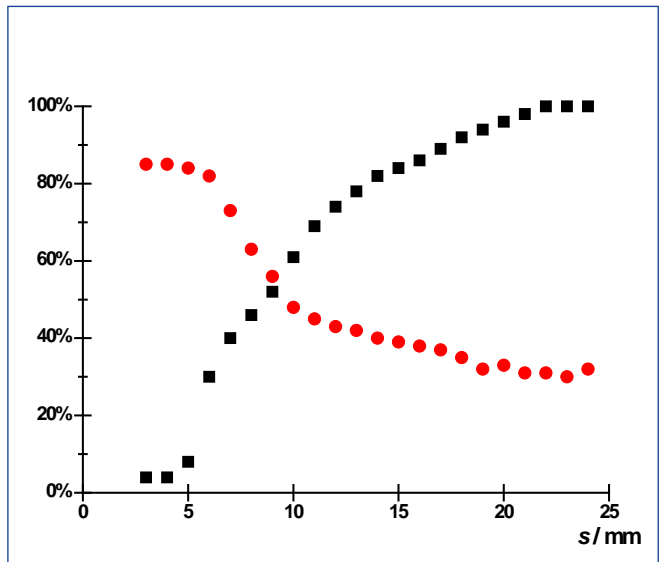

Relative intensity as a function of distance between the paraffin prisms

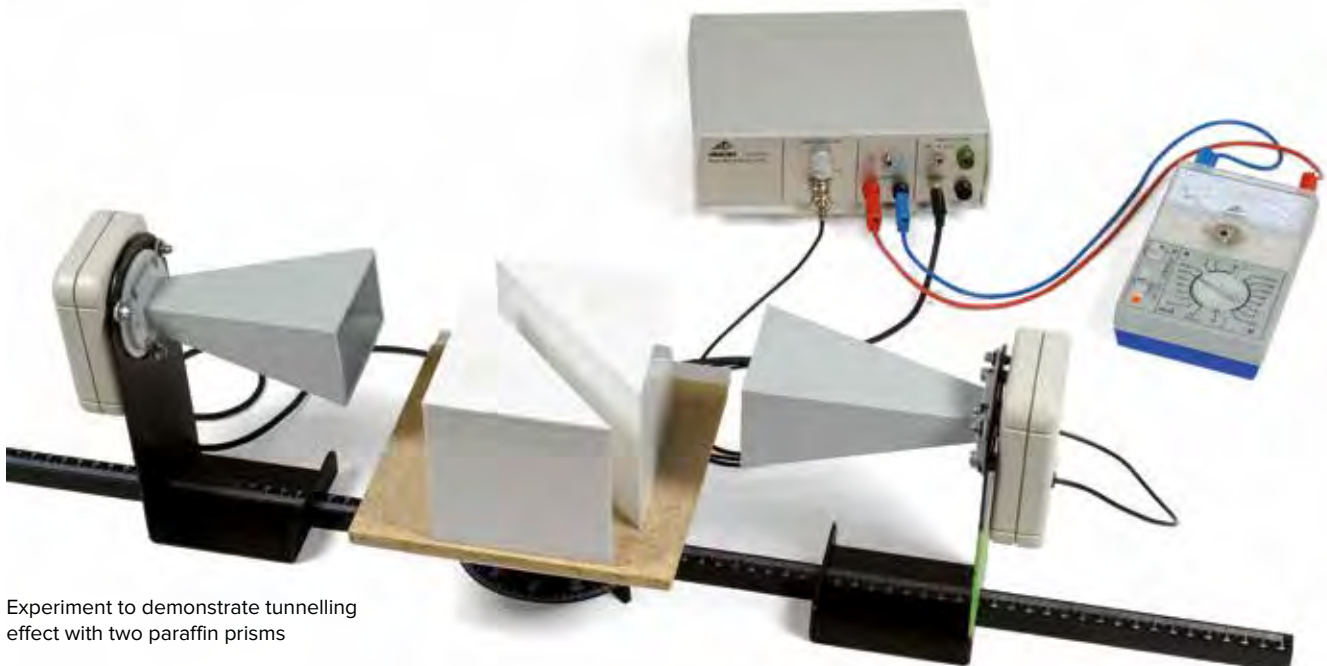

Experiment to demonstrate tunnelling effect with two paraffin prisms

Experiment Topics:

- Generation of circular and straight waves
- Reflection
- Refraction
- Diffraction
- Interference
- Doppler effect

Ripple Tank PM02

Equipment set with ripple tank for demonstrating and investigating properties of waves using the example of waves in water. The ripple tank is a shallow tank with a glass floor inside an aluminium frame, which can be filled with water. The tank can be aligned such that it is horizontal by means of adjustable feet. It is possible to generate both circular or straight waves in the tank by means of localised oscillations in air pressure and the frequency and amplitude of those waves can be set up using a control unit. An external counter can be connected to the control unit in order to measure frequency. An LED lighting system illuminates the ripple tank from above and takes the form of a stroboscope for which both asynchronous and synchronous frequencies can be set. Underneath the tank, there is an inclined mirror which projects the waves onto a viewing screen. Includes a drawer for storage of accessories and carrying handles for transport. Includes 12 V AC plug-in power supply.

Frequency range: Continuously adjustable, 1 – 60 Hz
 Stroboscope lighting: LED
 Terminals for frequency counter: 4-mm safety sockets
 Power supply: 100 – 240 V plug-in power supply
 Dimensions of tank structure: 400x300x320 mm³
 Dimensions of projection screen: 375x320 mm²

Contents:

- 1 Ripple tank with projection mirror, viewing screen and lighting system
- 1 Control unit
- 1 Plug-in power supply
- 1 Module for generating straight waves
- 1 Module for generating circular waves
- 1 Module for generating two interfering circular waves
- 1 Long hose
- 3 Obstructing bodies for reflection and refraction (prism, biconcave lens and biconvex lens)
- 4 Obstructing bodies for setting up a single slit and a double slit
- 1 Drainage hose

P-1017591



P-1017591



Refraction of water waves at a converging lens



Reflection of water waves at a "concave mirror"



Drawer for accessories on the back

Experiment Topics:

- Excitement of periodic and non-periodic waveforms
- Deflection, phase and amplitude
- Frequency and wavelength
- Phase and group velocities
- In-phase and out-of phase superimposition of waves
- Reflection of a wave
- Standing waves

Water Wave Channel

Wave channel for demonstrating or investigating the basic properties of waves using waves in water. An acrylic duct is filled with water and a sinusoidal wave is generated that propagates with no reflection at the end thanks to an absorber mechanism. The frequency and thus the wavelength of the resulting movement can be varied continuously. In order to investigate reflection, the absorber at the end can be removed. Two exciting mechanisms are supplied that can be operated in or out of phase and the waves they generate can be viewed separately or superimposed. By applying a pulsed input to the exciters, non-periodic waves can be generated.

Supply voltage: 9 – 12 V DC
 Power consumption: 40 W max.
 Connectors: 4 mm safety sockets
 Frequency range: Continuously adjustable
 Dimensions: approx. 1500x150x290 mm³
 Weight: approx. 12.6 kg

P-1000807

Additionally required:

P-1003312 DC Power Supply 0 – 20 V, 0 – 5 A
 (230 V, 50/60 Hz)

or

P-1003311 DC Power Supply 0 – 20 V, 0 – 5 A
 (115 V, 50/60 Hz)

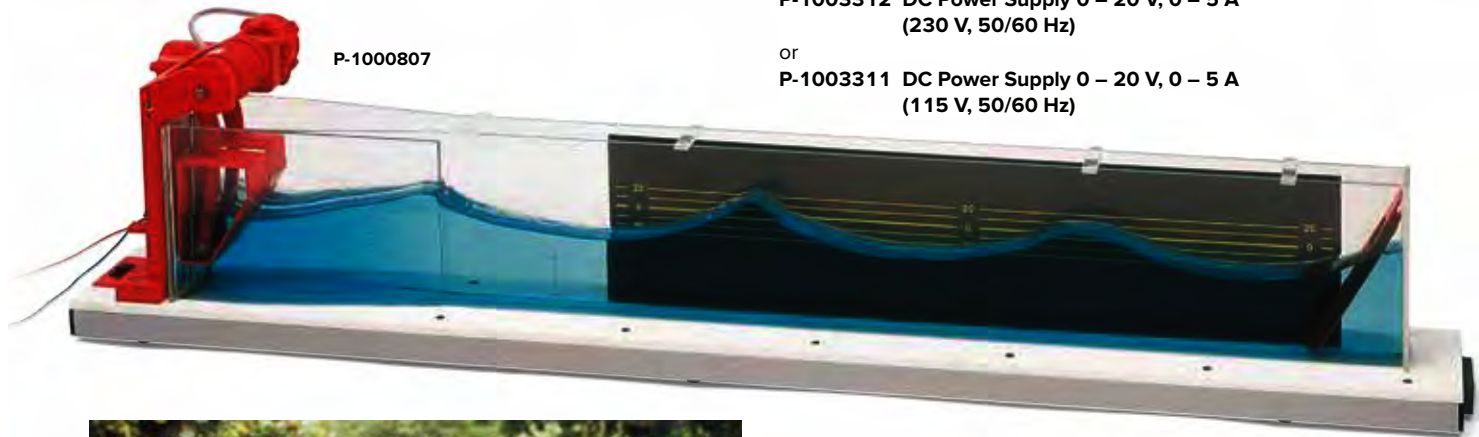

P-1000807



P-1008687

Helical Spring Snakey

Very long helical spring for demonstrating and investigating transverse and longitudinal waves.

Length: 2 m up to 14 m
 Total number of turns: 1300
 Coil diameter: 25 mm
 Weight: 1400 g

P-1008687

Coil Spring Slinky

Long coil spring for demonstrating the propagation and reflection of longitudinal waves.

Length: 0.2 m up to 5 m
 Total number of turns: 330
 Coil diameter: 70 mm
 Weight: 550 g

P-1003516

P-1003516



Accessories for Spring Oscillations

Accessories ideal for vibration generator (P-1000701) for demonstrating standing longitudinal waves in a coil spring. Consisting of angled stand rod, coil spring and connector pin for attachment of the spring to the vibration generator.

Rod: 450 mm x 8 mm diam.
Spring constant: 3.9 N/m

P-1000703

Additionally required:
P-1000701 Vibration Generator

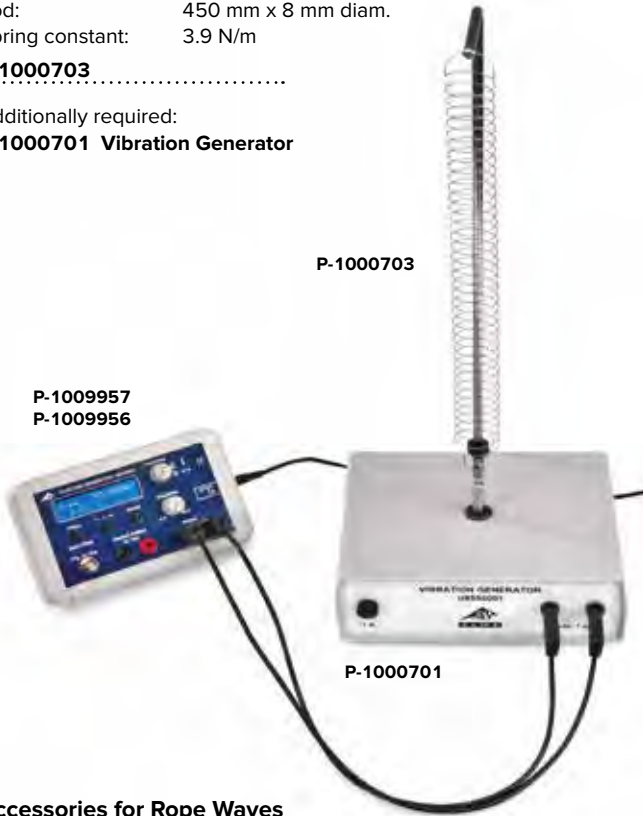

Resonance Wire, Ring Shaped

Accessories for vibration generator (P-1000701) for demonstrating the vibration knots in determination of different frequencies. Wire ring with 4 mm plugs.

Diameter: 290 mm

P-1000707

Additionally required:
P-1000701 Vibration Generator

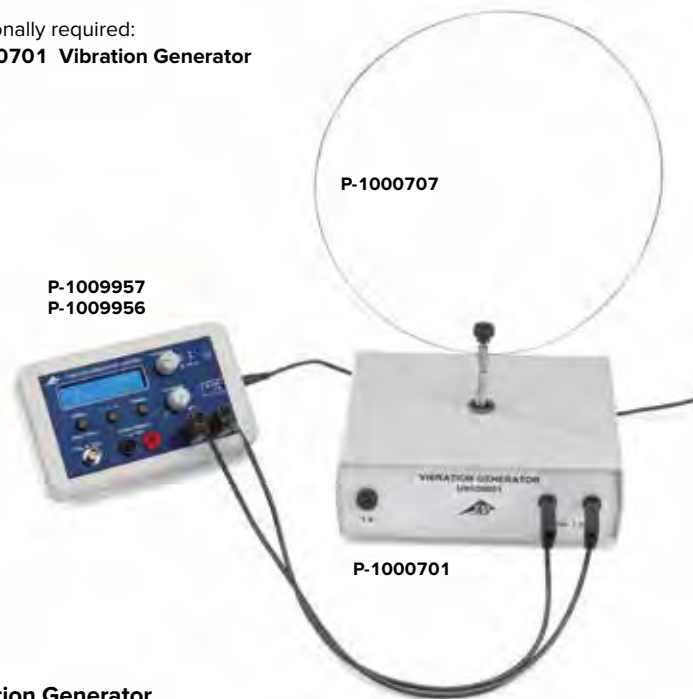

Accessories for Rope Waves

Accessories ideal for vibration generator (P-1000701) for the investigation of standing transversal waves and their wavelengths as a function of the rope tension and the frequency. Consisting of a base plate with stand rod, holder for dynamometer, deflection device and rubber rope.

Rope: 1 m
Base plate: approx. 180x180x25 mm³

P-1008540

Additionally required:
P-1000701 Vibration Generator
P-1003106 Dynamometer 5 N

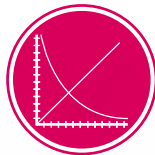

UE1050700
PDF online



Vibration Generator

Tough vibration generator for exciting oscillations and waves mechanically, e.g. in coil springs, a rubber cord, a wire ring or a Chladni plate. In robust plastic housing including mounting pin with 4 mm socket for attaching accessories (Chladni plates, resonance wire, rubber band etc.). Including holder for stand rod (up to 8mm diam.) on the rear side of the apparatus for the demonstration of standing waves in a coil spring. The generator is equipped with overload protection.

Connection: via 4 mm safety sockets
Impedance: 8 Ω
Frequency range: 0 up to 20 kHz
Overload protection: 1 A fuse
Dimensions: approx. 200x160x70 mm³
Weight: approx. 1.4 kg

P-1000701

Additionally required:
P-1009957 Function Generator FG 100 (230 V, 50/60 Hz)
or
P-1009956 Function Generator FG 100 (115 V, 50/60 Hz)

Rubber Band

For demonstrating stationary waves and wave propagation e.g. Using the vibration generator (P-1000701). Wound on a board, 25 m, 2 mm diam.

P-1000702

Additionally required:
P-1000701 Vibration Generator



Chladni's Plates

Inexpensive metal plates for generating acoustically excited figures in fine dry sand, as in the experiment by Chladni. To be used for instance in conjunction with vibration generator (P-1000701). With 4 mm plugs.

Chladni Plate, circular, 240 mm diam.

P-1000705

Chladni Plate, square, 180x180 mm²

P-1000706

Additionally required:
P-1000701 Vibration Generator



DC Motor 12 V

Compact experiment motor – can also be used as a tachogenerator, oscillation generator or for the excitation of rope waves. The motor has a coreless rotor and thus has a high starting torque at a lower moment of inertia. It is characterised by a very short starting time, smooth running and low running noise. On its axis, the motor has a threaded bush with a screw on retaining pulley. Thus, plates and levers can also be fixed on to the axis.

- Nominal voltage/current: 12 V/260 mA DC
- Run-up voltage/current: 0.5 V/45 mA DC
- Power consumption: 3.6 W
- Nominal speed: 3900 rpm
- Nominal rated torque: 0.5 Ncm
- Direction of rotation: reversible
- Connection: via 4-mm safety sockets
- Dimensions in mm: approx. 130x55 mm²
- Weight: approx. 200 g

P-1001041



Band Wave Device

Robust apparatus for demonstrating transverse standing waves on a rope and investigating how wavelength depends on the tension in the rope and on the frequency.

- Dimensions: 700x150x230 mm³
- Weight: approx. 4.4 kg

Contents:

- 1 Chassis
- 1 Rubber cord
- 1 Pulley
- 1 Axle clip
- 2 Axle rods
- 2 Universal clamps
- 2 Stand rods, 400 mm
- 1 Dynamometer, 5 N

P-1000808

- Additionally required:
P-1001041 DC Motor 12 V
P-1001038 Sine-Wave Generator
P-1000866 Transformer 12 V, 25 W (230 V, 50/60 Hz)
 or
P-1000865 Transformer 12 V, 25 W (115 V, 50/60 Hz)

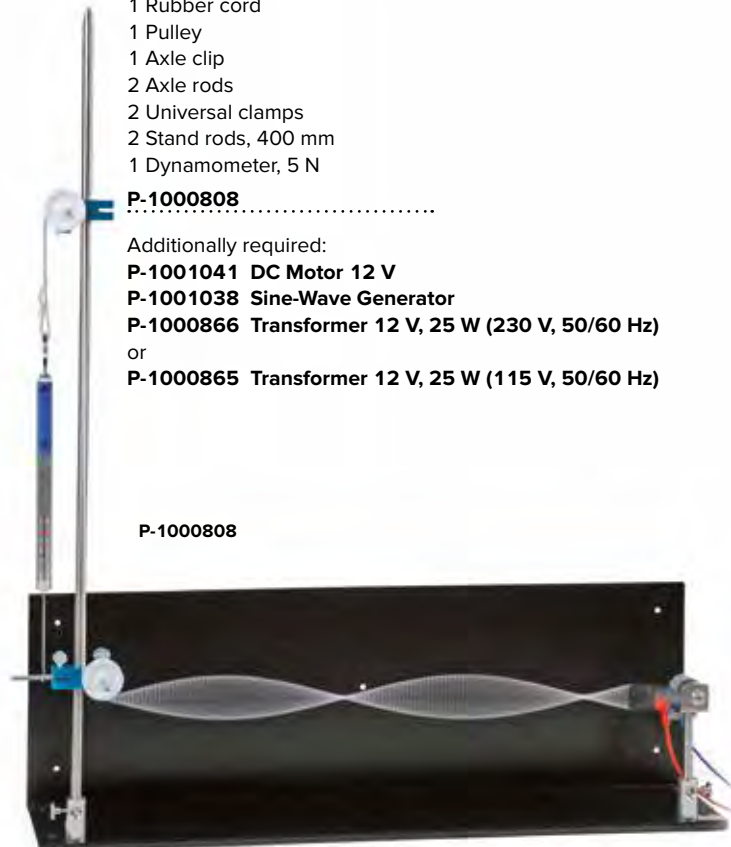



Wave Machine, Manual
 Demonstration equipment for displaying propagation, reflection, diffraction and superimposition of transverse waves. A chain of wooden double-ended pendulums joined together by a bifilar thread. Two handles allow the chain to be held by hand and excited.
 Number of double pendulums: 79
 Length: 3 m
 Weight: approx. 0.8 kg
P-1003524.....



P-1003524

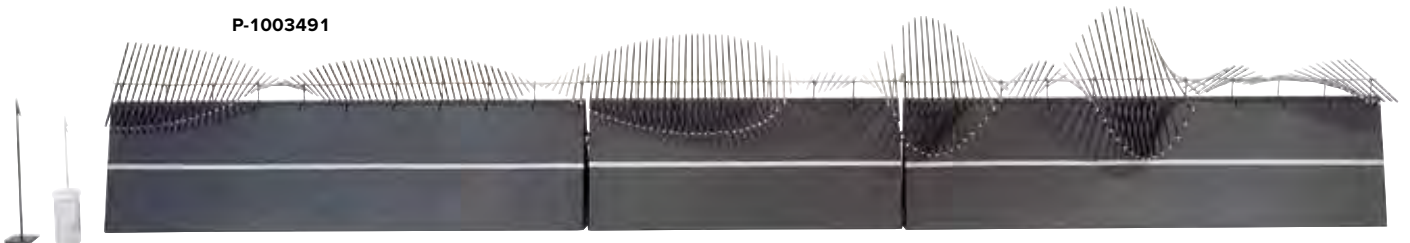

P-1003491

Experimental Topics:

- Propagation of a moving wave
- Wavelength, frequency and phase velocity
- Reflection of waves at fixed or moving ends
- Standing waves and resonance in the case of fixed or moving ends
- Constructive and destructive reinforcement of waves
- Propagation and speed of communication for a disturbance of equilibrium.
- Reflection of a disturbance of equilibrium at fixed or moving ends
- Damping of moving waves
- Reflection at a transition (experiment only possible with full set)
- Coupling at a transition (experiment only possible with full set)

Demonstration Wave Machine, Complete Set

Supplement to the demonstration wave machine comprising a module with short pendulum bars, a transition module and two module couplers. If the two models with differing bar lengths and thus differing wave velocities are coupled together, then reflections can be observed at the point where they are joined together. This can be avoided by adding the transition module.
 Length of bar module 1: 460 mm
 Length of bar module 2: 230 mm
 Length of bars for transition module: 230 – 460 mm
 Total length: 2440 mm
P-1003491.....

Demonstration Wave Machine, Single Module

Wave machine for conducting various demonstration experiments to show the behaviour and properties of transverse waves. The motion of the wave is demonstrated by a chain of 73 steel pendulum bars each soldered at their mid-point along a rod spring that can be subjected to torsion. The ends of the bars are painted on one side in fluorescent paint and on the other side with white paint. The machine is mounted on a foldable steel base. A damping mechanism is also supplied and a retaining clamp on a stem for demonstrating reflections at a fixed end.
 Number of bars: 73
 Length of bars: 460 mm
 Total length: 920 mm
P-1003492.....

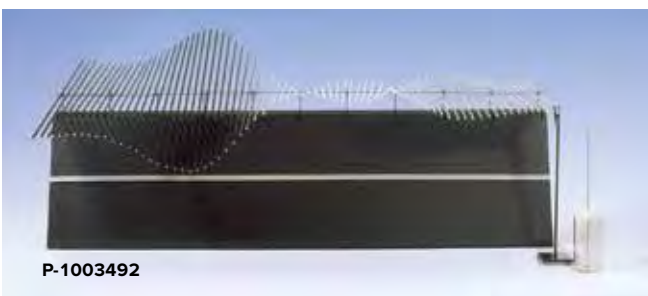

P-1003492

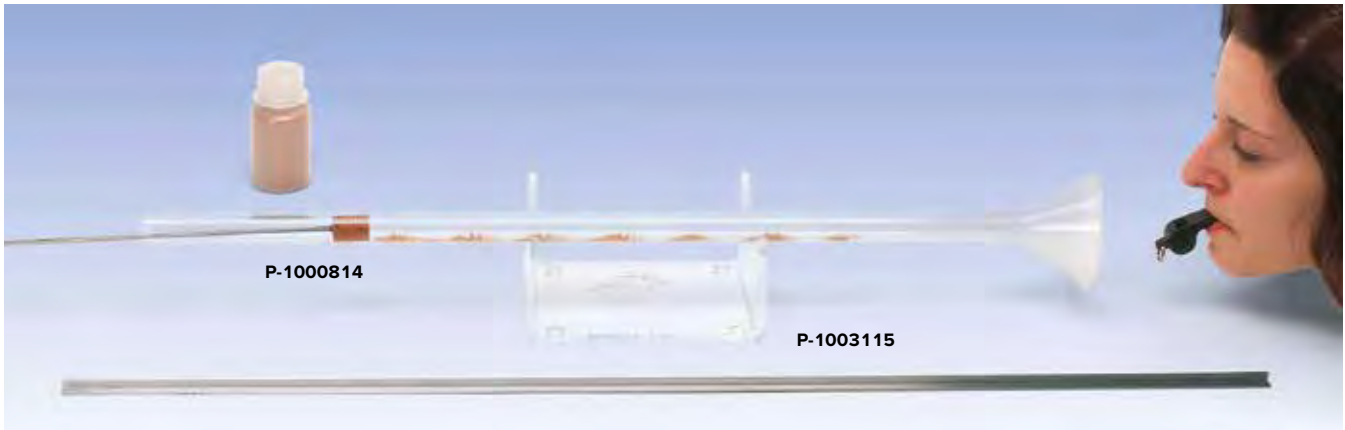

Kundt's Tube

Glass tube for demonstrating standing sound waves and calculating wavelengths of sound using cork powder in a method devised by Kundt. Cork powder is spread evenly throughout the tube by means of a filler chute. Then a sound source, e.g. a whistle, a 1700 Hz tuning fork (P-1002607) or a horn speaker (P-1000811), is used to excite the powder into a regular pattern of nodes and antinodes. The effective length of the tube can be altered by means of a piston.

Length: 600 mm
 External diameter: 20 mm
 Internal diameter: 17 mm

Contents:

- 1 Glass tube with funnel
- 1 Plunger
- 1 Filler chute
- 1 Whistle
- 1 Bottle of cork powder

P-1000814

Additionally recommended:
P-1000964 Acrylic Stands

P-1000815



Cork Powder, 10 g Bottle

Fine cork powder for use in Kundt's glass tube (P-1000814).

P-1000815

structive or destructive interference. Audible resonances occur when the length of the oscillating column of air is an odd integer multiple of a quarter wavelength of the sound.

Height of resonance tube: 1 m
 Diameter of resonance tube: 3 cm
 Scale: 98 cm
 Divisions: 1 mm
 Height of expansion vessel: 24 cm
 Diameter of expansion vessel: 7 cm
 Weight (without accessories and stands): 3.3 kg approx.

Contents:

- 1 Resonance tube with scale
- 1 Expansion vessel
- 1 Silicone tube
- 2 Horizontal clamps
- 1 Standard tuning fork, a₁ = 440 Hz
- 1 Beater

P-1018475

Additionally required:

- P-1002936 Stainless Steel Rod, 1000 mm**
- P-1001044 Stand Base, A-Shaped, 200 mm**
- P-1002830 Universal Clamp**



Experimental Topics:

- Resonances in an oscillating column of air
- Standing sound waves
- Determination of wavelengths of sound waves in air
- Determination of speed of sound in air

new

Quincke's Resonance Tube

Quincke's resonance tube is used for demonstrating interference effects in standing sound waves. The equipment set consists of a resonance tube with a millimetre scale which is partially filled with water and is connected to an expansion vessel with a tube. The column of air above the water is excited to oscillate by using a tuning fork (or optionally a loudspeaker). By raising the expansion tank, the level of water inside the tube can be raised as well, which therefore reduces the height of the air column. The sound wave emitted by a sound source above the one open end of the tube is superimposed on the wave reflected from the surface of the water which results in con-

Experiments on Sound Waves and the Speed of Sound

Determination of the speed of sound by measuring the time it takes for a sound pulse to cover a given distance in air and in other gases

Number / Description	Art. No.
1 Kundt's tube E	P-1017339
1 Pulse box K	P-1017341
1 Microphone probe, long	P-1017342
1 Microphone probe, short	P-4008308
1 Microphone box (230 V, 50/60 Hz)	P-1014520
or	
1 Microphone box (115 V, 50/60 Hz)	P-1014521
1 Microsecond counter (230 V, 50/60 Hz)	P-1017333
or	
1 Microsecond counter (115 V, 50/60 Hz)	P-1017334
2 HF patch cords, BNC/4-mm plugs	P-1002748
1 Pair of safety experiment leads	P-1002849
A variety of technical gases, if required	

Determine the speed of sound by measuring the time it takes for a sound pulse to cover a given distance as a function of temperature

Number / Description	Art. No.
1 Kundt's tube E	P-1017339
1 Pulse box K	P-1017341
1 Microphone probe, long	P-1017342
1 Microphone probe, short	P-4008308
1 Microphone box (230 V, 50/60 Hz)	P-1014520
or	
1 Microphone box (115 V, 50/60 Hz)	P-1014521
1 Microsecond counter (230 V, 50/60 Hz)	P-1017333
or	
1 Microsecond counter (115 V, 50/60 Hz)	P-1017334
1 Heating rod K	P-1017340
1 DC power supply, 0 – 20 V, 0 – 5 A (230 V, 50/60 Hz)	P-1003312
or	
1 DC power supply, 0 – 20 V, 0 – 5 A (115 V, 50/60 Hz)	P-1003311
1 Digital Quick-Response pocket thermometer	P-1002803
1 K-Type NiCr-Ni Immersion Sensor, -65° C to 550° C	P-1002804
2 HF patch cords, BNC/4-mm plugs	P-1002748
2 Pairs of safety experiment leads	P-1002849

Quantitative investigations of standing waves in closed and open tubes – Determination of the speed of sound from wavelength and frequency

Number / Description	Art. No.
1 Kundt's tube E	P-1017339
1 Microphone probe, long	P-1017342
1 Microphone box (230 V, 50/60 Hz)	P-1014520
or	
1 Microphone box (115 V, 50/60 Hz)	P-1014521
1 Function generator FG 100 (230 V, 50/60 Hz)	P-1009957
or	
1 Function generator FG 100 (115 V, 50/60 Hz)	P-1009956
1 Analogue Multimeter ESCOLA 30	P-1013526
1 Pair of safety experiment leads	P-1002849
1 HF patch cord, BNC/4-mm plugs	P-1002748

Frequency analysis of standing waves in a closed tube

Number / Description	Art. No.
1 Kundt's tube E	P-1017339
1 Microphone probe, long	P-1017342
1 Microphone box (230 V, 50/60 Hz)	P-1014520
or	
1 Microphone box (115 V, 50/60 Hz)	P-1014521
1 Function generator FG 100 (230 V, 50/60 Hz)	P-1009957
or	
1 Function generator FG 100 (115 V, 50/60 Hz)	P-1009956
1 USB oscilloscope 2x50 MHz	P-1017264
1 HF-Patch Cord	P-1002746
1 HF patch cord, BNC/4-mm plugs	P-1002748
1 Pair of safety experiment leads	P-1002849

Determination of the time it takes for sound pulses to travel given distances in an enclosed space

Number / Description	Art. No.
1 Microphone probe, short	P-4008308
1 Microphone box (230 V, 50/60 Hz)	P-1014520
or	
1 Microphone box (115 V, 50/60 Hz)	P-1014521
1 Microsecond counter (230 V, 50/60 Hz)	P-1017333
or	
1 Microsecond counter (115 V, 50/60 Hz)	P-1017334
1 Connecting Lead with Two Metal Rods	P-1017344
1 Pocket Measuring Tape, 2 m	P-1002603
1 HF-Patch Cord, BNC/4-mm plugs	P-1002748

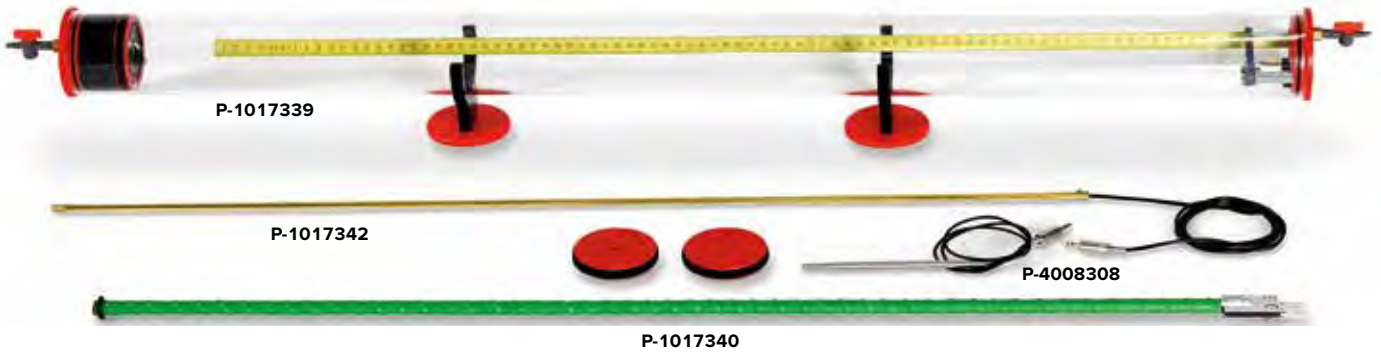

Kundt's Tube E

Sound tube made of transparent acrylic with loudspeaker and movable scale for quantitative investigation of sound waves in air or other gases, in particular for measurement of wavelength and speed of sound. With two stand bases, capillary disc, sensor disc, two hose connectors with stopcock for filling with gas, fitting and guide for long microphone probe, hole for short microphone probe, plus holder and connector for heating rod K.

Frequency range:	20 to 5000 Hz
Length of sound tube:	1000 mm
Diameter of sound tube:	70 mm
Scale:	950 mm
Hose connectors:	5 mm diameter
Speaker power output:	3 W
Impedance of speaker:	50 Ω
Weight:	1.25 kg approx.

P-1017339

Heating Rod K

Heating rod for warming air in Kundt's tube E up to about 50°C.

Operating voltage:	max. 12 V
Power consumption:	36 W
Temperature in Kundt's tube:	max. 50°C
Connectors:	Pair of 4-mm plugs
Dimensions:	900 mm x 11 mm mm diam. approx.

P-1017340

Additionally required:

P-1003312 DC power supply, 0 – 20 V, 0 – 5 A (230 V, 50/60 Hz)

or

P-1003311 DC power supply, 0 – 20 V, 0 – 5 A (115 V, 50/60 Hz)

Microphone Probe, Long

Miniature microphone at the end of a long rod for measuring changes in sound pressure in Kundt's tube E. With thread for attaching probe disc of Kundt's tube E.

Frequency range:	20 Hz – 16 kHz
Diameter of rod:	6 mm
Length of rod:	900 mm
Connecting lead:	1 m approx., with 3.5-mm jack plug

P-1017342

Microphone Probe, Short

Miniature microphone at the end of a short rod for measuring changes in sound pressure.

Frequency range:	20 Hz – 16 kHz, (1 – 20 Hz and 16 – 42 kHz, non-specified tolerance range)
Diameter of rod:	6 mm
Length of rod:	140 mm
Connecting lead:	0.6 m approx., with 3.5-mm jack plugs

P-4008308

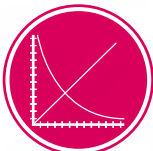

UE1070310
PDF online

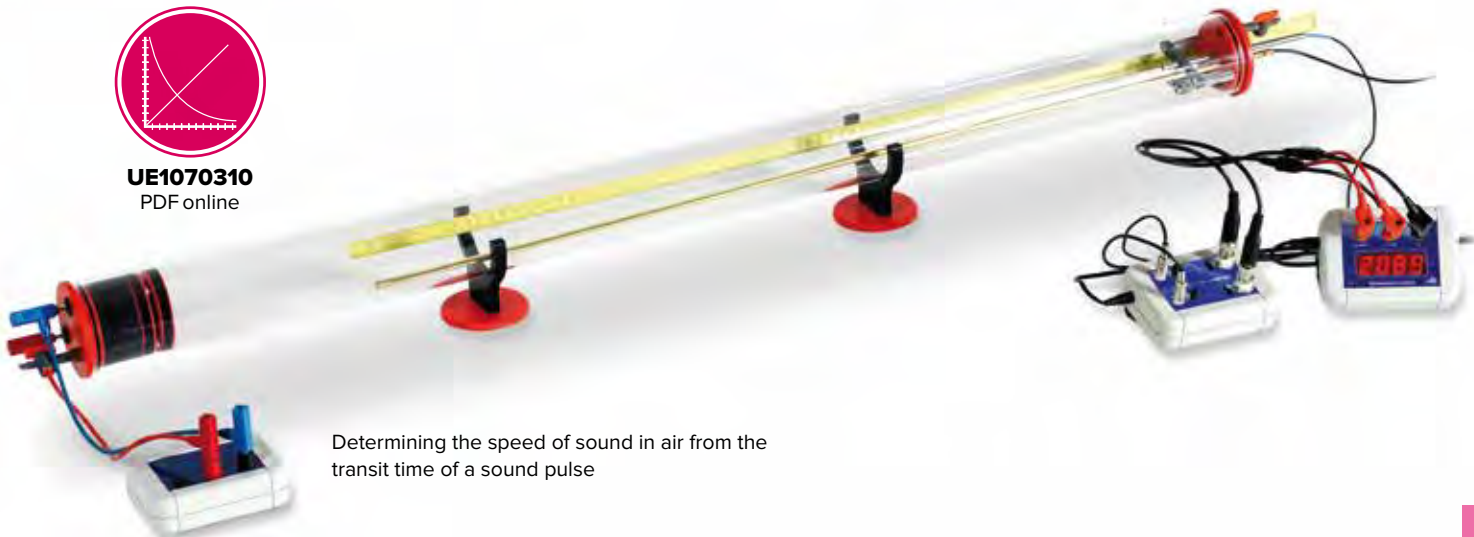

Determining the speed of sound in air from the transit time of a sound pulse

Microsecond Counter

Easy to use counter for measuring time in microseconds. Particularly well suited for measurements made in conjunction with the microphone box. Includes 12 V AC plug-in power supply. The counting procedure is started via the Start input and halted by means of the Stop input. Each new start causes the counter to automatically reset to zero. Both inputs respond to a rising edge and are equipped internally with pull-up resistors.

- Measuring range: 1 – 9999 μ s
- Resolution: 1 μ s
- Precision: Quartz precision
- Internal resistance: 2.4 k Ω (Start input), 5.6 k Ω (Stop input)
- Switching edges for both inputs: Rising edge
- Display: 4-digit LED
- Connectors: 4-mm safety sockets
- Power supply: 12 V AC, 500 mA plug-in power supply
- Dimensions: 100x75x35 mm³ approx.
- Weight: 400 g approx. including plug-in supply

Microsecond Counter (230 V, 50/60 Hz)

P-1017333

Microsecond Counter (115 V, 50/60 Hz)

P-1017334



P-1017333
P-1017334



P-1014520
P-1014521

Microphone Box

All-purpose dual-channel amplifier for long or short microphone probes. Particularly suitable for use with microsecond counters in experiments for determining speed of sound, including 12 V AC plug-in power supply. Both channels can be individually switched between the operating modes, "Signal" for connecting an oscilloscope, "Level" for connecting a voltmeters and "Pulse" for connecting a microsecond counter. The trigger threshold for the pulse depends on the gain of the pre-amp, which is adjustable.

- Band width: 10 Hz to 42 kHz
- Gain: 20 to 70x
- Output impedance: 1 k Ω
- Output signal: Switchable between Signal, Level and Pulse
- Signal: 0 – 14 Vpp
- Level: 0 – 7 V DC
- Pulse: Low: 0 V, high: 8 V DC, length: 150 ms
- Inputs: 3.5 mm jack plugs
- Outputs: BNC socket
- Power supply: Via 12 V AC, 500 mA plug-in power supply
- Dimensions: 100x75x35 mm³
- Weight, including power supply: 450 g approx.

Microphone Box (230 V, 50/60 Hz)

P-1014520

Microphone Box (115 V, 50/60 Hz)

P-1014521

Additionally required:

- P-1017342** Microphone probe, long
- or
- P-4008308** Microphone probe, short



P-1017344

Connecting Lead with Two Metal Rods

Pair of metal rods with a connecting lead for use with the microphone box in order to start measurements of time for the sound pulses in free space.

- Length of lead: 75cm
- Connectors: 2x 4-mm safety plugs, 3.5mm-jack plug
- Rods: 110 mm x 10 mm diam.

P-1017344



P-1017341

Pulse Box K

Electronic switch which outputs an electrical pulse to a connected speaker at the press of a button. Power supplied via 9 V block battery.

- Dimensions: 100x75x35 mm³ approx.

P-1017341

Experiment Topics:

- Speed of propagation of sound pulses in various rods
- Comparison between the propagation of longitudinal and transverse waves
- Standing sound waves in short rods
- Polarity of reflections at the ends of the rods
- Multiple reflection at the ends of longer rods

P-1018469
P-1018468



Sound

Advantages

- Compact set-up on lab benches
- Non-contact and low-attenuation measurement of sound waves

Equipment Set "Sound Propagation in Rods"

Equipment set for investigating propagation of sound and determining the speed of sound in solid rods of various materials. The set includes various test rods, two microphone probes and a microphone box for connection to an oscilloscope. Contained in a sturdy plastic case with foam inlays in the shape of the apparatus and a transparent lid.

Contents:

- 6 Test rods, 200 mm, made of glass, transparent acrylic (perspex), PVC, wood (beech), stainless steel and aluminium
- 4 Test rods, 100 mm, made of copper, brass, stainless steel and aluminium
- 1 Test rod, 400 mm made of stainless steel
- 2 Beaters
- 2 Microphone probes
- 1 Microphone boxes
- 1 Plug-in power supply 12 V AC
- 3 Rubber mats, 50x40x5 mm³

Equipment Set "Sound Propagation in Rods" (230 V, 50/60 Hz)

P-1018469

Equipment Set "Sound Propagation in Rods" (115 V, 50/60 Hz)

P-1018468

Additionally required:

Dual-channel oscilloscope, e.g.

P-1017264 USB Oscilloscope, 2x50 MHz

Experiment Topics:

- Directions of sound
- Determining differences in time for sound to propagate to left and right ears
- Effect of linear distortions on cavity resonance

Equipment Set "Stereophonic Hearing"

Equipment set for investigation of directionality of sound and determining differences in time for sound to propagate to left and right ears by generation of knocking sounds in a closed tube. The effect of linear distortions on the directionality of cavity resonance can also be investigated by dipping two ends of a tube, at the same time or in alternation, into a beaker which is either empty or half-filled with water. The set consists of a stethoscope with various tubes and a plastic beaker in a rugged plastic case with foam inlays in the shape of the apparatus and a transparent lid.

Contents:

- 1 Stethoscope
- 2 Spare earpieces
- 1 Tube, 1 m
- 2 Tubes, 0.5 m
- 2 Toothpicks
- 1 Plastic beaker
- 1 Storage case

P-1018551

Additionally recommended:

P-4008308 Microphone Probe, Short (2x)

P-1014520 Microphone Box (230 V, 50/60 Hz)

or

P-1014521 Microphone Box (115 V, 50/60 Hz)

P-1017333 Microsecond Counter (230 V, 50/60 Hz)

or

P-1017334 Microsecond Counter (115 V, 50/60 Hz)

P-1002748 HF Patch Cord, BNC/4-mm Plug (2x)



P-1018551



Waves and Sound



P-1000700

Demonstration Tuning Fork

Large tuning fork for demonstrating the vibrating legs of the fork.
Length: 750 mm

P-1000700

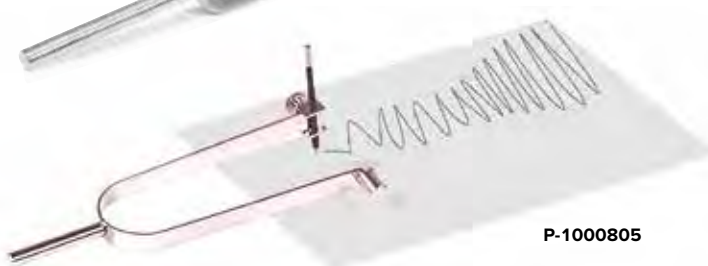

P-1000805

21 Hz Tuning Fork with Plotter Pen

Tuning fork that allows for plotting oscillations on a sheet of paper. The oscillation is triggered by pushing the prongs of the fork together. The oscillation of the tuning fork is highly visible both with the naked eye or with the aid of a stroboscope. Includes a plotter pen with holder and a counterweight.

Natural frequency: 21 Hz
Length: 245 mm
Total weight: approx. 170 g

P-1000805

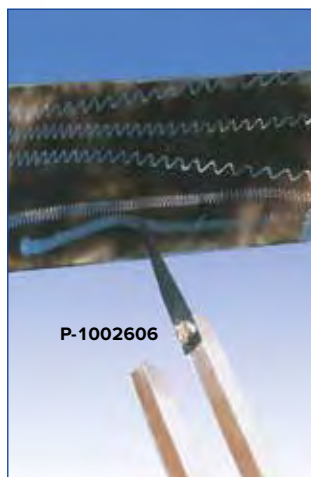

P-1002606

Recording Tuning Fork, c 128 Hz

For demonstrating and recording sound oscillations. For recording the oscillations on a sooted glass plate one of the two prongs is equipped with a metal tip. Complete with a glass plate.

Natural frequency: 128 Hz
Total length: approx. 280 mm
Glass plate: 120x50 mm²

P-1002606



P-1002609

Tuning Fork, 2000 Hz

Tuning fork with handle for demonstrating the Doppler Effect. The effect can be exhibited very impressively by moving the fork slowly toward and away from the audience.

Natural frequency: 2000 Hz
Length of the tuning fork: 220 mm

P-1002609

Additionally recommended:

P-1002610 Hard Striking Hammer



P-1002606



P-1002608

Light Metal Tuning Fork, 1700 Hz

Suitable as a source of intense, high-frequency sound, for example, for producing stationary sound waves in Kundt's tube.

Natural frequency: 1700 Hz
Length: approx. 105 mm

P-1002607

Light Metal Tuning Fork, 1000 Hz

Suitable as a source of intense, high-frequency sound, for example, for producing stationary sound waves in Kundt's tube.

Natural frequency: 1000 Hz
Length: approx. 115 mm

P-1002608



P-1002613

Tuning Fork, 440 Hz, on Resonance Box

Long-sustain tuning fork mounted on a resonant chamber made of clear grained fir wood. Removable, includes a soft striking hammer (P-1002614).

Natural frequency: 440 Hz
Length of the tuning fork: approx. 170 mm
Resonance box: 180x90x50 mm³

P-1002613

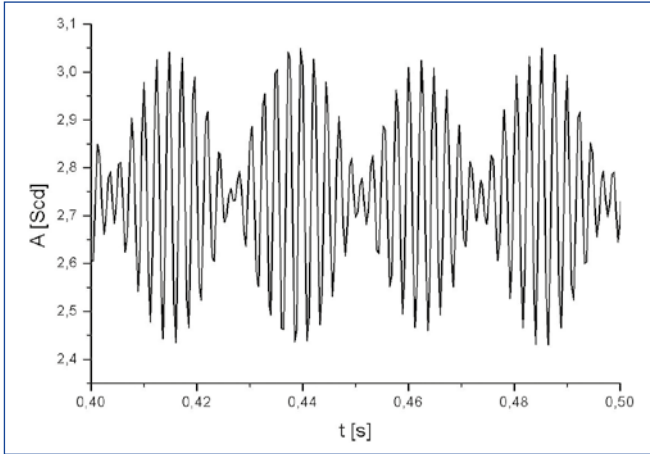

Acoustic beats

Pair of Tuning Forks, 440 Hz, on Resonance Boxes

Pair of Tuning Forks for experiments on beats; the tuning forks are identical with P-1002613. Complete with a soft striking hammer (P-1002614) and a pair of tuning weights (P-1002611).

P-1002612

Set of Tuning Forks, C-Major Chord, on Resonance Boxes

Set of four tuning forks for demonstrating C major chord. Supplied on a sound box made of clear grained pine for especially long sustain from which the tuning forks can be removed. Includes a soft striking hammer (P-1002610).

Natural frequency:	Internal length:
c' = 256 Hz	300 mm
e' = 322 Hz	240 mm
g' = 384 Hz	190 mm
c'' = 512 Hz	140 mm

P-1002615

Set of Tuning Forks for the C-Major Scale

Set of 8 tuning forks in a storage case.

Frequencies:

- c' = 256 Hz
- d' = 288 Hz
- e' = 320 Hz
- f' = 341½ Hz
- g' = 384 Hz
- a' = 426⅔ Hz
- h' = 480 Hz
- c'' = 512 Hz

P-1002605

Striking Hammer, Soft

Rubber beater particularly suited for striking low-frequency tuning forks, e.g. tuning forks on sound box (P-1002612, P-1002613 and P-1002615).

P-1002614

Striking Hammer, Hard

Aluminium beater particularly suited for striking high-frequency 2000 Hz tuning fork (P-1002609).

P-1002610

Pair of Tuning Weights (not shown)

Two tuning weights for changing the frequency of tuning forks for beat experiments; intended for the 440-Hz tuning fork mounted on a resonance box (P-1002613).

P-1002611

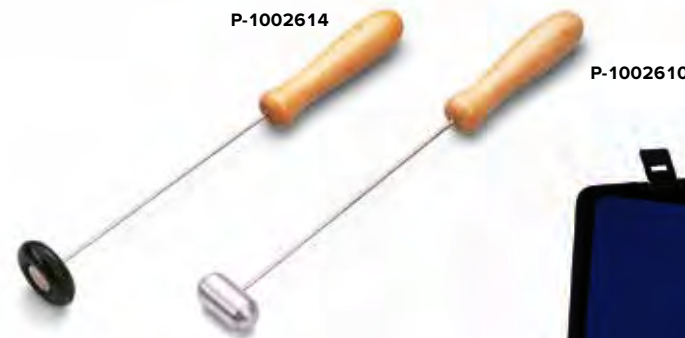
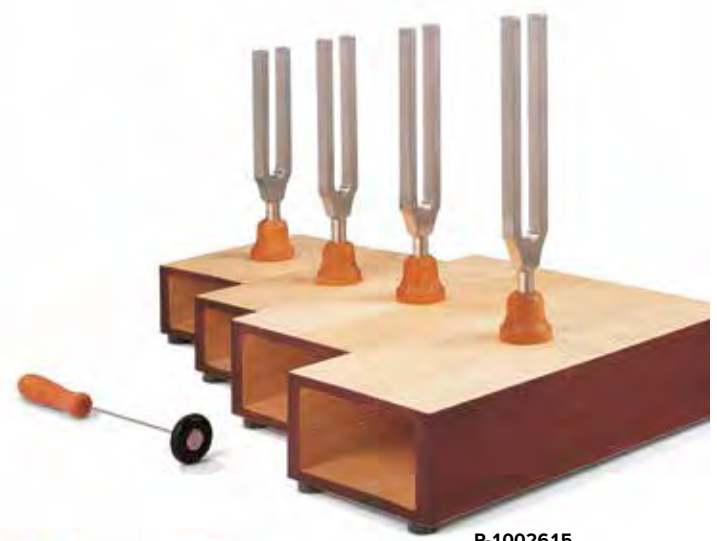

Sound

Waves and Sound

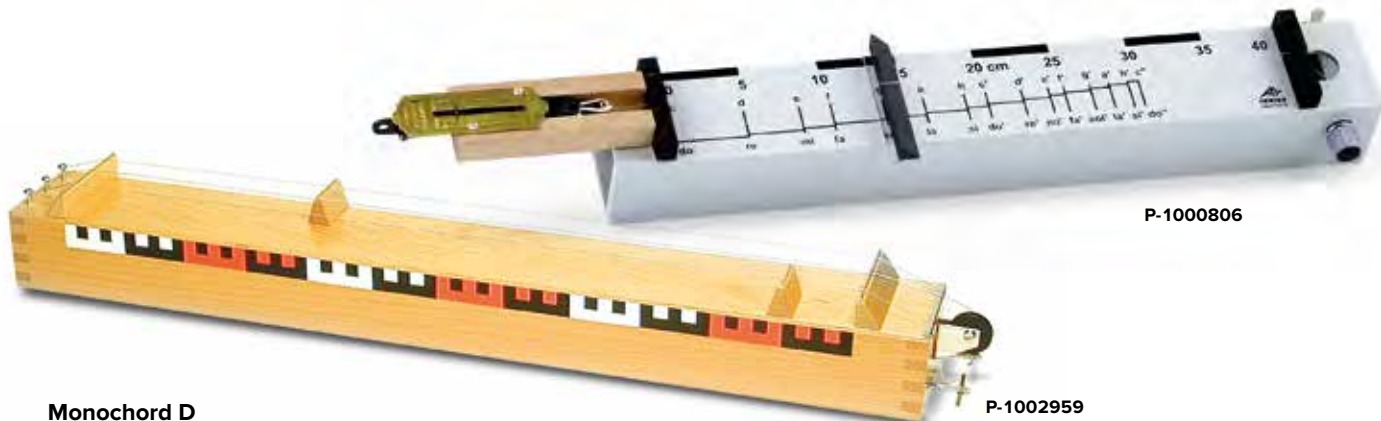

P-1000806

P-1002959

Monochord D

Demonstration apparatus for investigating the relationship between the pitch of a sound and the length of the string making it. Also for investigating overtones formed by harmonic waves with intermediate nodes and the dependence of the pitch on string tension. Two steel strings and one nylon string are stretched over a sound box. The tension on two of the strings can be altered by tuning pegs while the other's tension can be changed by adding weights or using a dynamometer at the end of a cord passed over a pulley. The effective length of the strings can be altered by means of two moving bridges.

- Scale length: 600 mm
- Scale division: cm and dm
- Dimensions of the resonance box: approx. 700x90x70 mm³

P-1002959

Additionally recommended:
P-1003375 Dynamometer 50 N

Set of 3 Monochord Strings (not shown)

Two steel and one nylon string with eyelets, fitting the monochord D (P-1002959).

P-1002960

Reed Pipe

Reed pipe with 8 valves, tuned to C major.
 Length: 37 cm
 Weight: approx. 90 g

P-1012893

Helmholtz Resonator

Hollow glass bulb with a narrow tube leading out for demonstrating acoustic resonance. The fundamental oscillation is generated by blowing into the opening or tapping on the outside of the bulb. The elasticity and inertial mass of the air in the bulb cause the bulb to act as an acoustic resonator with a highly distinct resonant frequency. The frequency is dependent on the dimensions of the bulb and the tube. With a whole set of Helmholtz resonators it is possible to demonstrate how tones combine to form a tonal mixture.

- Opening on the glass bulb: 14 mm diam.
- Length of tube: 15 mm
- Internal diameter of tube: 6 mm

Helmholtz Resonator, 70 mm diam.

P-1003520

Helmholtz Resonator, 52 mm diam.

P-1003521

Helmholtz Resonator, 40 mm diam.

P-1003522

Helmholtz Resonator, 32 mm diam.

P-1003523



P-1003520

P-1003521

P-1003522

P-1003523

Monochord

A wooden box open at both ends, with a clamping mechanism for a string to demonstrate the relationship between pitch and string length and the dependence of pitch on string tension. Includes an indicator for the tensioning force, as well as a steel string (tuned to B) and a nylon string.

Dimensions: approx. 490x70x60 mm³

P-1000806

P-1009924

P-1012893

Lip Whistle

Lip whistle for experiments on pitch as a function of resonance space. Closed wooden whistle with a round cross-section and movable piston, chromatic range from g¹ (392 Hz) to g² (794 Hz).
 Frequency range: approx. 400 Hz – 800 Hz
 Resonance space: approx. 170 mm x 20 mm diam.
 Length: approx. 250 mm

P-1009924

Metallophone

Metallophone for demonstrating a C major scale from c¹ to g². Note labels, frequencies and frequency ratios are printed on the instrument. With striking hammer.

Dimensions: approx. 320x210 mm²
 Weight: approx. 510 g

P-1000804

P-1000804

P-1000811

Horn Speaker

Speaker that approximates to being a point source for excitation of Kundt's tube (P-1000814), for example.
 Frequency range: 300 Hz – 10 kHz
 Max. load capacity: 8 W (max. 10 W)
 Impedance: 8 Ω
 Shaft: 10 mm diam.
 Weight: approx. 650 g

P-1000811

Additionally recommended:

P-1001038 Sine Wave Generator

P-1000866 Transformer (230 V, 50/60 Hz)

or

P-1000865 Transformer (115 V, 50/60 Hz)



Wide-Band Loudspeaker

Ideal sound source for acoustics experiments in the frequency range 60 Hz to 23 kHz. Includes connecting lead with 4 mm safety plugs.

Frequency range: 60 Hz to 23 kHz (-10 dB)

Power capacity: 100 W (as per IEC 268-5)

Impedance: 4 Ω

Tweeter: ½" diam.

Woofers: 5½" diam.

Dimensions: 225x150x142 mm³

Weight: 1.8 kg

P-1000812

Additionally recommended:

P-1001038 Sine Wave Generator

P-1000866 Transformer (230 V, 50/60 Hz)

or

P-1000865 Transformer (115 V, 50/60 Hz)



P-1000812



Recording of ultrasonic standing waves



Ultrasound Transducer, 40 kHz, Equipment Kit

Equipment set for experiments on geometric and wave-mechanical acoustics. Based on the piezo-effect discovered by the Curie brothers, an AC voltage is applied to a piezo-electric body causing it to oscillate. Sound waves can also be used to excite the body and the oscillations can be converted into an electrical voltage signal.

Resonant frequency: 40 kHz approx.

Band width: 6 kHz approx.

Capacitance: 1900 pF

Connector: BNC

Stand rod: 150 mm x 10 mm diam.

Dimensions: 40 mm x 20 mm diam.

Contents:

1 Ultrasonic transmitter, on stand rod

1 Ultrasonic receiver, on stand rod

1 Projection screen

1 Ruler, 1 m

P-1009888

Equipment:

P-1009888 Ultrasound Transducer, 40 kHz, Equipment Kit

P-1009957 Function Generator FG100 (230 V, 50/60 Hz)

or

P-1009956 Function Generator FG100 (115 V, 50/60 Hz)

P-1002727 Analogue Oscilloscope, 2x 30 MHz

P-1001046 Barrel Foot, 0.5 kg (3x)

P-1002746 HF Cable

P-1002752 T-Piece, BNC

P-1002751 Adapter, BNC Jack/4-mm-Plugs



P-1009888

Debye-Sears Effect

In 1932, Debye and Sears for the first time demonstrated the refraction of light as it passed through a liquid being subjected to high-frequency vibrations. In this process, the density maxima and minima of a stationary ultrasonic wave act like the elements of an optical diffraction grating. The grating constant here is equal to half the wavelength and therefore dependent on the frequency and speed of the ultrasonic waves transmitted through the medium (e.g. water, glycerin, oil).



Equipment for the Debye-Sears Effect:

P-1002576 Ultrasonic CW Generator with Probe

P-1002578 Test Vessel

P-1002577 Laser Diode for the Debye-Sears Effect, red

P-1002579 Laser Diode for the Debye-Sears Effect, green

Ultrasonic cw Generator with Probe

Ultrasonic generator for producing continuous, high-powered ultrasonic waves in a wide frequency range of up to 20 MHz. Includes a multi-frequency probe with waterproof cast sound transmitting surface. The transmitter frequency can be adjusted in digital increments of 1 Hz and is indicated on a display. The acoustic power can also be adjusted by regulating the transmitter voltage of the ultrasonic converter and can be turned on and off separately. The transmitting mode is shown by an indicator lamp. The transmitter voltage is shown on an LCD display. The transmitter output supplies a sinusoidal signal with a maximum amplitude of 46 Vpp. In addition, the transmission frequency is output in the form of a TTL signal via a BNC socket and as a generator signal (max. 2.5 Vpp) via another BNC socket. The equipment can therefore be used as a flexible signal generator. There is also a suitable voltage output for controlling the red and green laser diodes in the Debye-Sears experiment. This, too, can be turned on and off separately and has its own indicator light.

Generator frequency:	≤ 20 MHz
Multi-frequency probe:	1 – 13 MHz
Frequency increment:	1 Hz
Signal amplitude:	2 – 46 Vpp
Transmitted signal output:	Continuous wave/burst/pulse signal, separately switchable with indicator light
TTL output:	0 – 5 V, square signal
Signal generator output:	Sine, triangle, square with continuous wave, burst or pulse signal, max. 2.5 Vpp
Connection:	Laser diode, adjustable, separately switchable with indicator light
Display:	Current, voltage and frequency (continuous wave, burst, pulse) or alternatively laser voltage, signal generator voltage and signal type (sine, triangle, square), burst length and pulse repeat frequency
Mains voltage:	100 – 240 V, 50/60 Hz
Dimensions:	approx. 255x170x265 mm ³

P-1002576

Test Vessel, Complete

Test vessel made of glass, for conducting the Debye-Sears experiment or projecting ultrasonic waves with divergent light. Lid with probe adjustment via three adjustment screws can be used to produce a stationary wave. A laser fixture with a lens mounting aligned vertically to the sound axis. Includes a plano-convex lens on a square mounting for the projection.

Test vessel:	100x100x120 mm ³
Testing volume:	approx. 1 litre
Laser fixture:	18 mm diam.
Lens:	Plano-convex, f = 100 mm, 16 mm diam.

P-1002578

Laser Diode for Debye-Sears Effect, Red

Laser diode of protection classification II with 1 m connector lead and barrel connector for connecting ultrasonic cw generator (P-1002576). Fits the laser holder of test vessel (P-1002578). All lasers have been measured to determine their wavelength specifically and the results are logged.

Wavelength:	approx. 650 nm
Power:	< 1 mW
Supply voltage:	3 V DC
Current consumption:	max. 30 mA
Dimensions:	90 mm x 17 mm diam.

P-1002577

Laser Diode for Debye-Sears Effect, Green

Laser diode of protection classification IIIa with 1 m connector lead and barrel connector for connecting ultrasonic cw generator (P-1002576). Fits the laser holder of test vessel (P-1002578). All lasers have been measured to determine their wavelength specifically and the results are logged.

Wavelength:	approx. 532 nm
Power:	< 5 mW
Supply voltage:	3 V DC
Current consumption:	max. 250 mA
Dimensions:	90 mm x 17 mm diam.

P-1002579

Ultrasonic Echoscope GS200

Operational device for conducting ultrasonic experiments in reflection mode (pulse echo) or in through-transmission mode with ultrasonic probes 1 MHz (P-1018617), 2 MHz (P-1018618) and 4 MHz (P-1018619). With the built-in transmission and receiving unit, time gain control (TGC), integrated analogue-digital converter and micro-processor for connection to the measuring and evaluating computer via the USB interface. Connection of the ultrasonic probes via robust snap-in sockets with automatic probe recognition. Compensation for losses of intensity in ultrasonic sound pulses passing through solid or liquid bodies by means of TGC with selectable threshold, start point, end point and TGC ramp. The most important function signals (trigger, TGC, A-scan signal (amplitude signal) and ultrasound signal) are available via BNC sockets on the front of the device. Includes measurement and evaluation software for Windows operating systems. Screen display of the ultrasound signals (echogram) and the simultaneous TGC signal, whereby the A-scan signal and ultrasound signal can be recorded individually or both simultaneously in the echogram as a function of time or penetration depth. Display of all currently set system parameters (operating mode, transmission level, gain, connected ultrasound probes) calculation of frequency and cepstrum of ultrasound signal (FFT), depiction of 2-dimensional ultrasonic images (B-image) and the time characteristic of time motion reflection layers (time-motion methods). Ultrasonic probes not included in scope of delivery.

Frequency range: 1 – 5 MHz

Transmission signal: Dirac pulse ($< 1 \mu\text{s}$, 0 – 300 V)

Transmission power: 0–30 dB, in 5 dB steps

Gain: 0–35 dB, in 5 dB steps

TGC: Continuously adjustable threshold value, start value, rise time and gain time, Maximum gain of approx. 32 dB

Outputs (front): TGC, trigger, ultrasound signal, A-scan signal via a BNC socket in each case

Probes connectors: 2, selectable for transmit, receive or duplex modes

PC connection: USB

Scanning rate: 10, 25, 50 and 100 MHz

Power consumption: approx. 20 VA

Mains voltage: 100 – 240 V, 50/60 Hz

Dimensions: approx. 226x169x325 mm³

P-1018616

Experiment Topics:

- Propagation of longitudinal and transverse ultrasonic waves in solid bodies
- Determining velocity of longitudinal and transverse ultrasonic waves in solid bodies
- Determination of shear modulus, modulus of elasticity and Poisson number
- Attenuation of sound in solid bodies and liquids
- Frequency dependence of sound attenuation
- Time-dependent gain
- Frequency dependence of resolution
- Recording brightness images
- Recording ultrasonic echoes from moving boundaries (time-motion mode)
- Measurement of anomalies

Equipment:

P-1018616 Ultrasonic Echoscope GS200

P-1002584 Equipment Set "Ultrasound in Solids"

P-1018617 Ultrasonic Probe 1 MHz, GS200 (2x)

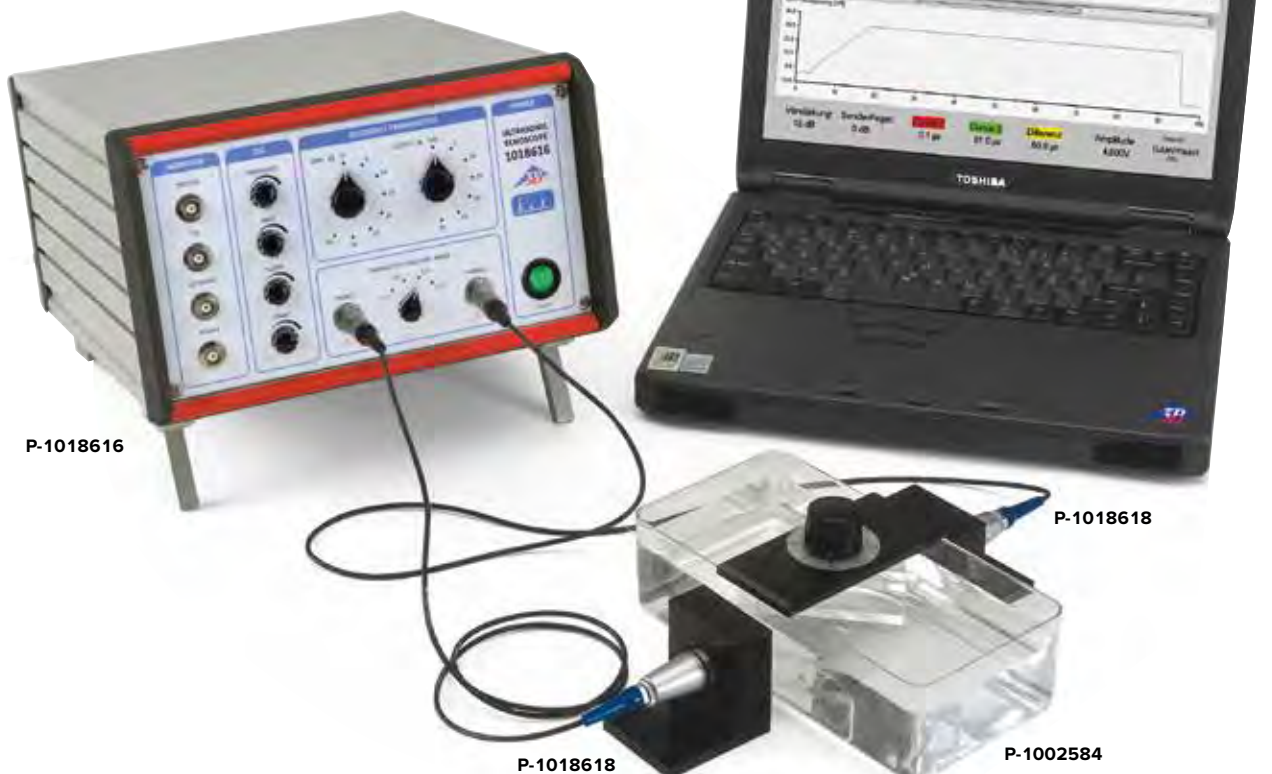

P-1018616

P-1018618

P-1018618

P-1002584



P-1002584

P-1002585

P-1002586



P-1018617

P-1018619

P-1018618

Ultrasound Probe 1 MHz, GS200

Ultrasound probe for tests involving large penetration depths or high acoustic power at low depth resolutions. It includes a 16-mm piezo-ceramic disc in a die-cast metal case and a 1-m long cable with a frequency-coded snap-in plug. The equipment is adapted to sound in water/acrylic glass.

Dimensions: 65 mm x 27 mm diam.
For use with ultrasonic echoscope GS200

P-1018617

Ultrasound Probe 4 MHz, GS 200

Ultrasound probe for investigations with small penetration depths and maximum depth resolution. It includes a 16-mm piezo-ceramic disc in a die-cast metal case and a 1 m long cable with a frequency-coded snap-in plug. The equipment is adapted to sound in water/acrylic glass.

Dimensions: 65 mm x 27 mm diam.
For use with ultrasonic echoscope GS200

P-1018619

Pair of Reflection Blocks with Delay Line

These polished polyacrylate blocks are used to investigate multiple echoes and measure frequency-dependent attenuation. A 4 MHz probe (P-1018619) is especially suitable for such measurements. An echo pattern comprising at least 3 echoes is recorded, and the spectra of the individual echoes analysed. The result of the analysis is a shift in the average frequency toward lower frequencies, due to a stronger attenuation of the signal's high-frequency components.

Dimensions: 80x40x10 mm³

P-1002587



P-1002587

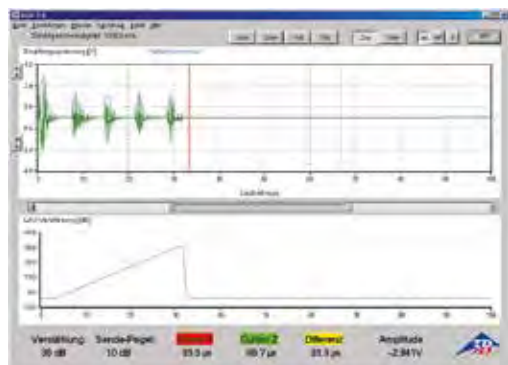

Multiple reflections from a mirror plate

Ultrasound Probe 2 MHz, GS200

Ultrasound probe for investigations at medium penetration levels and depth resolution. It includes a 16-mm piezo-ceramic disc in a die-cast metal case, adapted to sound in water/acrylic glass, a 1 m long cable with a frequency-coded snap-in plug.

Dimensions: 65 mm x 27 mm diam.
For use with ultrasonic echoscope GS200

P-1018618

Equipment Set "Ultrasound in Solids"

Equipment kit for the investigation of the propagation of longitudinal and transversal waves (shear waves) as well as for the determination of elastic constants (shear modulus, elasticity modulus and Poisson's ratio) in solid bodies. Further for the determination of ultrasonic attenuation in liquids by means of time dependent amplitude measurement with sliding reflector (P-1002585). Consisting of acoustic basin, polyacrylic test plate in holder with protractor scale and two probe holders to accommodate and precisely position two 1 MHz (P-1018617), 2 MHz (P-1018618) or 4 MHz (P-1018619) ultrasonic probes on the acoustic basin.

Sound trough: 200x100x60 mm³
Test plate: 104x75x50mm³
Protractor scale: 360°, 5° divisions
Polyacrylate block: 70x45x10 mm³

P-1002584

Additionally recommended:

P-1002585 Aluminium Test Block with Protractor Scale

P-1002586 Polyoxymethylene Test Block with Protractor Scale

Aluminium Test Block with Protractor Scale

This accessory to equipment set P-1002584 for longitudinal and transverse waves is used to examine the propagation of transverse waves in metals and ascertain the elastic constants of aluminium, such as its shear modulus, modulus of elasticity and Poisson ratio. The test block's very high reflectivity with high reflection coefficient in water provides sizeable signal amplitudes for measurements of attenuation in liquids (e.g. water, cooking oil or glycerine).

Protractor scale: 360°, 5° divisions
Aluminium block: 70x45x10 mm³
Dimensions: 104x75x50 mm³

P-1002585

Polyoxymethylene Test Block with Protractor Scale

This accessory to equipment set P-1002584 for longitudinal and transverse waves is used to examine the propagation of transverse waves in plastic and ascertain the elastic constants of polyoxymethylene (POM) such as its shear modulus, modulus of elasticity and Poisson ratio.

Protractor scale: 360°, 5° divisions
POM block: 70x45x10 mm³
Dimensions: 104x75x50 mm³

P-1002586

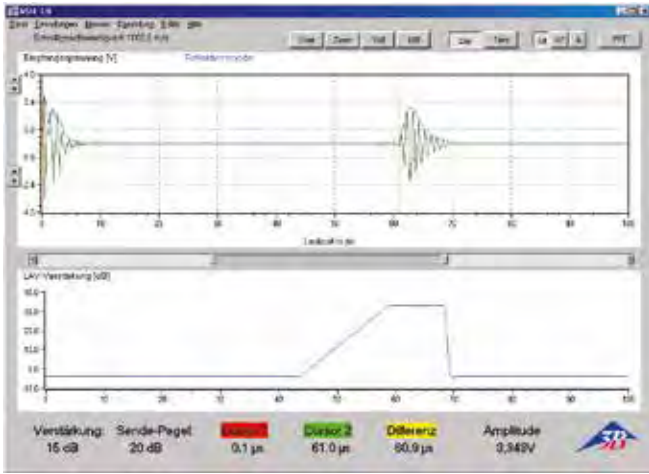

Pulse echo signal from a hole



P-1002589

Acrylic Body with Drilled Holes

Polished polyacrylic block with bores of various diameters and varying distance from the surface to determine the speed of sound and the attenuation of ultrasonic signals in polyacrylate, to localise defects, investigate aberrations resulting from acoustic shadows and ground returns, analyse frequency-dependent resolving power and display manual B-images.

Dimensions: 150x80x40 mm³

P-1002589

Additionally required:

P-1018616 Ultrasonic Echoscope GS200

P-1018617 Ultrasonic Probe 1 MHz, GS200

P-1018619 Ultrasonic Probe 4 MHz, GS200

P-1008575 Ultrasonic Coupling Gel



B-image: acrylic body with drilled holes

Heart Model

This double vessel with a rubber membrane and pressure regulator is used to demonstrate movement of the cardiac wall by means of the time-motion technique. In the experiment the membrane vessel produces images similar to the cardiac wall of a beating heart during echocardiography in medical diagnostics.

Dimensions: 160x70 mm²

P-1002590

Additionally required:

P-1018616 Ultrasonic Echoscope GS200

P-1018619 Ultrasonic Probe 4 MHz, GS200

P-1008575 Ultrasonic Coupling Gel



P-1002590



P-1002588

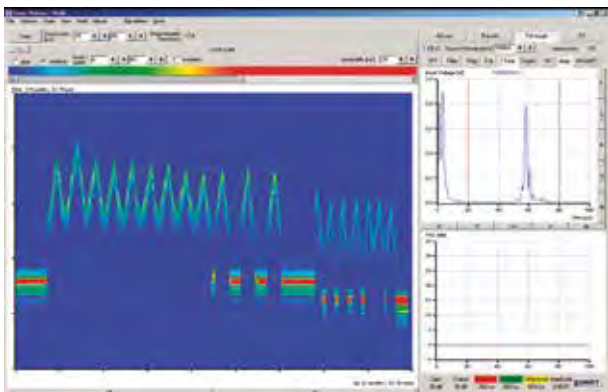

Time motion scan

Set of 3 Cylinders

These polished polyacrylate cylinders are used to ascertain the speed of sound and the attenuation of ultrasonic waves in transparent acrylic. Measurements can be performed in reflection mode or through-transmission mode.

Length : 40 mm, 80 mm and 120 mm

Diameter: 40 mm

P-1002588

Model Eye for Ultrasonic Biometry

Model of the human eye, enlarged to a scale of 3 to 1, including the cornea, the lens and glass bodies for demonstrating the fundamentals of ultrasonic biometry. The biometric ratios in the human eye (distance between cornea and lens, thickness of lens, distance between lens and retina) are very well suited to demonstrating measurement using a pulse-echo method with ultrasound. With the help of an ultrasonic echoscope GS200 (P-1018616) and a 2-MHz ultrasonic probe (P-1018618), typical echoes and the speed of sound can be measured. This allows the geometry of individual objects in the eye to be calculated. A lesion close to the back of the eye becomes apparent due to the diffuse nature of its echo.

Diameter: 80 mm

P-1012869



P-1012869

Additionally required:

P-1018616 Ultrasonic Echoscope GS200

P-1018618 Ultrasonic Probe 2 MHz, GS200

P-1008575 Ultrasonic Coupling Gel

Recommended for comparison:

P-1000259 Model of the Human Eye, 3 times full-size, 6 part

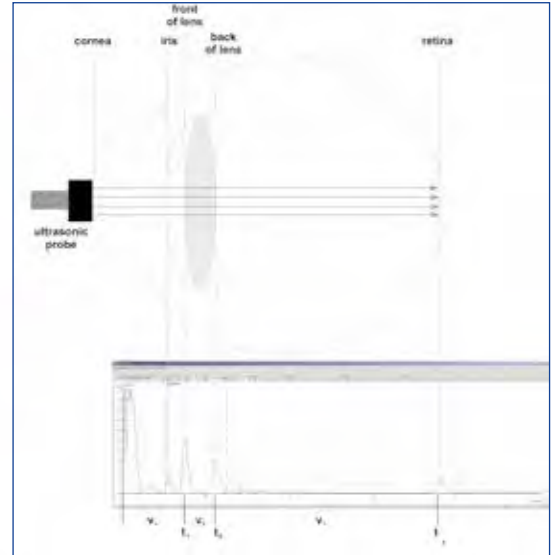

A-mode image and schematic diagram of the human eye

Single Breast Model with Benign Tumour

Model of a woman's breast made of 3B SKINlike™ silicone with simulated benign tumour for the demonstration of ultrasonic B-image mode.

P-1000345

Additionally required:

P-1018616 Ultrasonic Echoscope GS200

P-1018617 Ultrasonic Probe 1 MHz, GS200

P-1008575 Ultrasonic Coupling Gel

Ultrasonic Coupling Gel (not shown)

To secure the ultrasonic probes to solid test objects.

Contents: 250 ml

P-1008575

Doppler Phantom Fluid

Phantom fluid with excellent scattering characteristics for ultrasonic waves in the frequency range from 1 – 6 MHz and viscosity calibrated for ultrasonic Doppler experiments. In plastic bottle.

Contents: 1 l

Ultrasonic scattering: 1 – 6 MHz

Colour: blue

Diameter of

glass microspheres: 30 – 50 µm

P-1002574



P-1002574

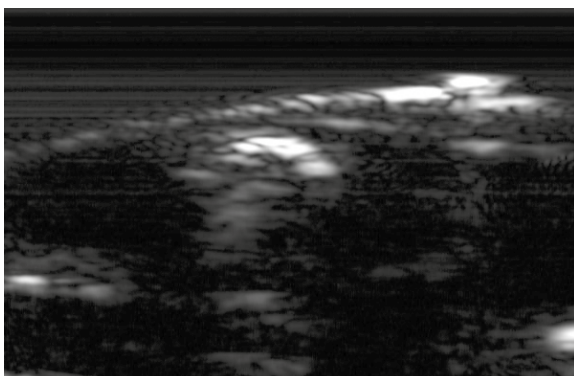

B-image: breast model

Equipment:

- P-1002571 Ultrasonic Doppler Apparatus**
- P-1002582 Ultrasonic Probe 2 MHz**
- P-1002572 Set of Doppler Prisms and Flow Tubes**
- P-1002573 Riser Tubes for Pressure Measurement**
- P-1002574 Doppler Phantom Fluid**
- P-1002575 Centrifugal Pump**
- P-1008575 Ultrasonic Coupling Gel**

Ultrasonic Doppler Apparatus

Ultrasonic device for carrying out experiments on the Doppler principle, on fluid mechanics and on Doppler sonography in the diagnosis of vascular problems. Includes measurement and evaluation software for Windows operating systems in order to display the measured signals and colour-coded Doppler spectra. If the radiated waves are reflected or scattered from moving particles or bubbles in fluid flow, the Doppler shift in frequency can be detected. The equipment detects the scattered waves and generates an audio signal at a volume that reflects the amplitude of the reflected signal and a frequency that reflects the speed of the scattering. At the same time, the amplitude is also displayed on an LED bar display. Sensitivity and volume can be adjusted by means of appropriate controls. The controller can also pass on data to a PC for detailed recording and evaluation. During measurement the current LF Doppler signal is displayed. Evaluation is by means of a Fourier transformation in the frequency domain and the result can be interpreted as the distribution of velocity within the flow.

- Frequency: 1 MHz, 2 MHz and 4 MHz
- Gain: 10 – 40 dB
- Display: LED bar display and acoustic signal with volume control
- PC connector: USB
- Mains voltage: 90 – 230 V, 50/60 Hz
- Dimensions: approx. 256x185x160 mm³

P-1002571

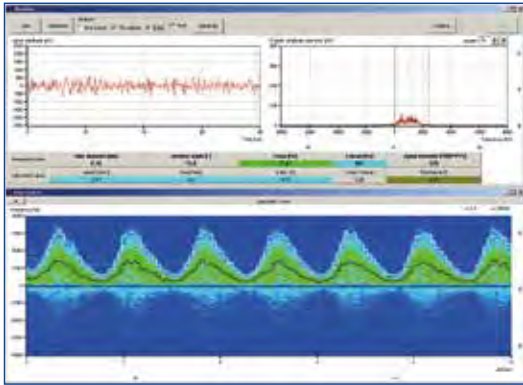

Centrifugal Pump

Pump for transporting liquids at a constant flow velocity which can be regulated continuously to any value and intended for the investigation of flow phenomena with laminar flow profiles. The pump has 3/8" plug-in connectors for insertion into a flow circuit (P-1002572) or an arm simulator (P-1012880). The display can be switched to show either speed or flow. The display of the flow can be calibrated to match the flow pressure. For Doppler sonographic experiments using a so-called arm phantom to simulate a real arm, the pump can be set to provide a pulsing flow (to simulate a heart beat) with a variable pulse frequency. This allows ultrasonic signals to be obtained which are typical for vascular diagnosis.

- Connectors: 2x 3/8"
- Max. flow: 6 l/min
- Display: LCD
- Mains voltage: 90 – 230 V, 50/60 HZ

P-1002575

Experiment Topics:

- Investigation of flowing liquids using ultrasonic waves
- Experiments on the Doppler principle
- Measurement of flow velocities
- Demonstration of laminar and turbulent flow
- Experiments on the continuity equation, Bernoulli's equation (static and dynamic pressure) and the Hagen-Poiseuille law (resistance to flow)

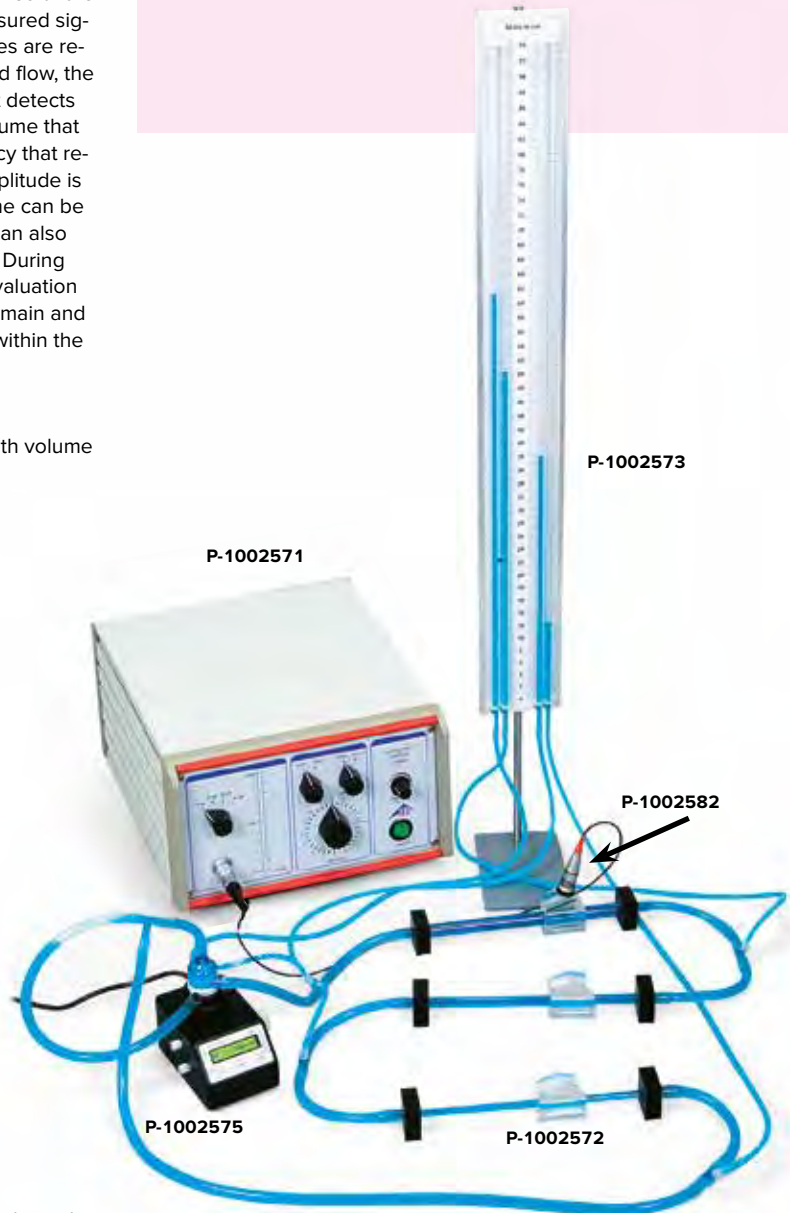

Set of Doppler Prisms and Flow Tubes

Equipment set including plastic tubes and hoses of various diameters for investigating flow phenomena using ultrasonic waves. Includes Doppler prisms for connecting an ultrasonic probe to the tubes or hoses at three different angles.

Contents:

- 1 Doppler prism 1/4"
- 1 Doppler prism 3/8"
- 1 Doppler prism 1/2"
- 1 Flow tube 1/4", 300 mm
- 1 Flow tube 3/8", 300 mm
- 1 Flow tube 1/2", 300 mm
- 1 Hose 1/4", 1000 mm
- 1 Hose 3/8", 3000 mm
- 1 Hose 1/2", 1000 mm
- Various hose connectors, T-pieces and accessories

P-1002572



P-1002572

Riser Tubes for Pressure Measurement

Set of four riser tubes with millimetre scales for measuring the relationship between pressures at up to four measuring locations in a flow circuit. Includes tubing and Luer-Lock connectors for attachment to a flow circuit and stand.

- Length: 1000 mm
- Connectors: Luer Lock, male
- Length of tubing: 1200 mm
- Tubing connector: 3/8" female Luer Lock connector

P-1002573



P-1002573

Ultrasonic Probe, 2 MHz

Ultrasonic probe for investigations at medium penetration levels and depth resolution. It includes a 16-mm piezo-ceramic disc in a die-cast metal case, adapted to sound in water/acrylic, a 1-m long cable with a frequency-coded snap-in plug.

Dimensions: 65 mm x 27 mm dia.
For use with Ultrasonic Doppler Apparatus

P-1002582



P-1002582

Arm Phantom Set

Model of a human arm for simulating Doppler sonographic examinations of blood vessels. Includes an ultrasonic Doppler probe and so-called phantom fluid for simulating blood. The model features a variety of tubing (simulating blood vessels), including one tube which simulates a blood vessel stricture or stenosis. Using the ultrasonic Doppler apparatus (P-1002571) and a centrifugal pump (P-1002575), it is possible to simulate typical examinations used in vascular diagnosis. Doppler spectra are measured for the flow through arteries and veins with both a pulsing flow (like a heart beat) and continuous flow, allowing sounds typical of Doppler sonography to be heard. One particularly interesting feature is the possibility of observing the change in the spectra and the Doppler sound due a stenosis (stricture) in the elbow. In addition, it is possible to calculate the flow index and resistance index from the curves measured with a pulsing flow.

Probe frequency: 2 MHz
Probe dimensions: 200 mm x 15 mm diam.
Length of lead: 1 m

Includes:

- Model arm with stenosis
- Silicone tubing
- 3/8" connectors
- Ultrasonic Doppler probe
- Phantom fluid to simulate blood, 250 ml
- Funnel
- Rubber stoppers

P-1012880

Equipment:

- P-1002571 Ultrasonic Doppler Apparatus**
- P-1002575 Centrifugal Pump**
- P-1012880 Arm Phantom Set**
- P-1008575 Ultrasonic Coupling Gel**

Experiment Topics:

- Doppler sonographic examinations of the human arm
- Measurement of the flow velocity of blood
- Recording of Doppler spectra and pulse curves
- Diagnosis of stenosis (vascular stricture) in an arm



P-1012880

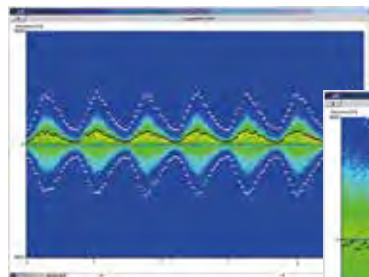

Doppler spectrum of arterial blood flow

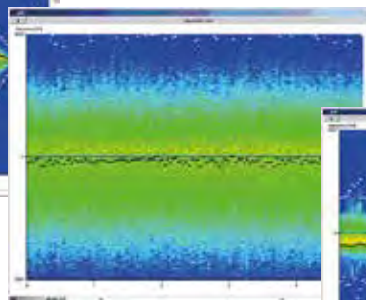

Doppler spectrum of a stenosis (stricture)

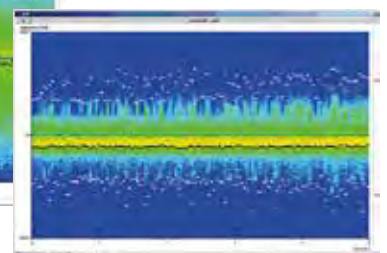

Doppler spectrum of blood flow in veins

Ultrasonic Computer Tomography

In order to control computer tomography by means of a computer, the AScan software supplied with the ultrasonic echoscope is used. It can generate mechanically scanned so-called B scans as well as ultrasonic tomographic images. The CT algorithm is incorporated into the AScan software in the form of a module. Both unfiltered and filtered attenuation and run-time scans, the current A scan, the configuration of the run-time dependent gain and the amplitude of the row scan currently being undertaken are all depicted graphically. In addition, the various scanner positions in millimetres and the current angle of rotation in degrees are displayed. The CT scan (attenuation and run-time scans) is updated after each row is scanned and enhanced step by step so that the emergence of the tomographic image can be understood in its individual stages. The CT and B scans can be exported and printed out. Depending on the time and the object being studied, the number of angular positions and the step range can be specified along with the length of the scan.

Equipment Ultrasonic Computer Tomography

Quantity/Description	Art.-Nr.
1 Ultrasonic echoscope GS200	P-1018616
1 CT scanner	P-1017782
1 CT controller	P-1017783
1 measuring trough	P-1017785
1 CT sample	P-1017784
2 Ultrasonic probes 1 MHz, GS200	P-1018617
1 Ultrasonic probe 2 MHz, GS200	P-1018618



P-1017782

CT Controller

Controller for operating the two stepper motors for the linear motion axis and the rotation axis of the CT scanner. Control of motion or direction of rotation, as well as linear speed and rotational velocity can be set manually or with a PC via a USB connection.



P-1017783

Output: 2 x Stepper motor controllers, bipolar, 5 V, max. 2 A
 Port: USB
 Supply voltage: 100 – 240 V, 50/60 Hz
 Power consumption: max. 50 VA
 Dimensions: 155x170x315 mm³

P-1017783

CT Scanner

CT scanner for turning and moving samples for the purpose of generating tomographic images. All turning and movement is carried out by means of stepper motors. While the measurement is taking place, the scanner moves the sample backwards and forwards between the ultrasonic sensors connected to the outside of the sample container in accordance with the CT algorithm. Includes a sample stage for making recordings of suitable objects for observation. The sample stage is immersed in a sample trough. The whole slider is height adjustable so that it is possible for the area of the sample under investigation to be modified.

Linear movement: max. 400 mm
 Local resolution: <10 μm
 Maximum speed of movement: 18 cm/min
 Turning angle: 0 – 360°
 Angular resolution: 0.225°
 Maximum angular velocity: 1 rpm
 Dimensions: 210x353x520 mm³

P-1017782



P-1017785

CT Measuring Trough

Sample trough for CT scanner made of thin transparent plastic. Includes several special fittings for attaching and connecting ultrasonic sensors to the sides of the trough. Since transparent acrylic exhibits a very low acoustic impedance step response as compared to water, reflections are largely eliminated.

Material: Acrylic
 Thickness of sides: 4 mm approx.
 Dimensions: 430x150x150 mm³

P-1017785

CT-Sample

Black plastic cylinder with non-uniform absorption and speed of sound within its interior. With magnetic holder for attachment to the revolving stage of the CT scanner. In the case of ultrasonic tomography, two different measurement variables can be recorded, absorption and speed of sound.

Diameter: 60 mm
 Height: 70 mm

P-1017784



P-1017784

Tomorrow's Energy Carriers

Fuel cells, electrolyzers, solar hydrogen technology – significant contributors to a sustainable energy supply in the future: preservation of the environment and resources while maintaining today's standard of living. Now you can demonstrate the mode of operation of this fascinating technology to your students. Pure water is broken down by means of electrolysis into hydrogen and oxygen for the purpose of energy storage with the help of regenerative energy. During reconversion of the gases in a fuel cell, electricity, heat and water are formed. The resolute use of membrane technology in the training and demonstration systems does away with the use of corrosive liquids and only distilled water is required.

Fuel Cell Demonstration System

Model showing the function of a hydrogen solar cell consisting of: • Solar module; • PEM electrolyser; • Hydrogen and oxygen accumulators; • PEM fuel cell; • Fan

Conveniently arranged on a baseplate.

Solar module: 2.0 V / 350 mA

Electrolyser: 1 W

Fan output: 10 mW

Dimensions: approx. 100x300x150 mm³

Weight: approx. 600 g

P-1002689



For your safety:

Exclusive use of distilled water.

No corrosive electrolytes such as potassium hydroxide (KOH).

Halogen Lamp 500 W (230 V, 50/60 Hz)

Strong light source for experiments, e.g. for use with solar energy basic kit (P-1000839). With handle.

P-1000894

Additionally required:

P-1002835 Stand Base

Spare Bulbs for Halogen Lamp – 500 W (230 V, 50/60 Hz)

P-1003536

Solar Energy Basic Kit

Set of equipment including four test bodies with different surface coating, heat insulators and covers for experiments on the utilisation of solar energy. Four series of measurements that can be completed in approximately 25 minutes elucidate the temperature characteristics and peaks of the test bodies when exposed to sunlight. The kit comes in a robust storage case.

Storage capacity: approx. 365x310x70 mm³

Weight: approx. 1 kg

Contents:

- 4 Solar measuring bodies, each of a different colour
- 2 Insulating housings
- 2 Mounts for the measuring bodies
- 1 Transparent acrylic plate
- 4 Thermometers, -10 – +110° C

P-1000839

Additionally required:

P-1000894 Halogen Lamp, 500 W (230 V, 50/60 Hz)



P-1000894



P-1000839



P-1000840

Bolometer

Designed to measure heat radiation from the sun, this device consists of an aluminium tube with a blackened front enclosed in a cardboard tube blackened on the inside. Includes a borehole for a thermometer.
 Aluminium tube: 30 x 40 mm diam. approx.
 Cardboard tube: 195 x 50 mm diam. approx.
 Weight: 350 g approx.

P-1000840

- Additionally required:
P-1003527 Thermometer, +10 – +30° C
P-1002833 Universal Clamp
Stand Equipment



P-1000824

Moll-Type Thermopile

Sensitive probe for measuring heat radiated by a black body or Leslie's cube, as well as for detecting visible light and ultra-violet radiation. Comprises a metal housing with a polished, conical reflector and a black surface 15 mm in diameter with 17 linked thermocouples. With two 4 mm connectors mounted on a stem.
 Sensitivity: approx. 0.28 mV/μW
 Internal resistance: approx. 1 Ω
 Setting duration: 40 s (95%)
 Tripod: 156 x 10 mm diam.
 Dimensions: 94 x 40 mm diam.
 Weight: approx. 200 g

P-1000824

- Additionally required:
P-1013527 Analogue Multimeter ESCOLA 100
P-1001046 Barrel Foot
2 Experiment leads

Greenhouse Effect Kit

A set of equipment permitting quick and easy experiments to demonstrate the effect of greenhouse gases on the absorption of infra-red radiation. Solar radiation received by the earth is simulated here by means of short-wave infra-red radiation that is attenuated by absorption in water and visible light from a reflector lamp. Infra-red radiation emitted by the earth is simulated by heating a black metal disc. Both types of radiation are made to pass through air or butane gas in a metal tube and subsequently registered with a thermopile. Comparison of the obtained values reveals that long-wave infra-red radiation is absorbed to a high degree by butane gas. Consequently butane gas released into the atmosphere causes it to heat up, i.e. butane gas is a greenhouse gas.

Contents:

- | | |
|-----------------------------------|-------------------------|
| 1 Base plate | 1 Metal tube, simple |
| 1 Lamp holder with reflector lamp | 1 Metal tube, with taps |
| 1 Cuvette on stem | 2 Mounting stems |
| 1 Black metal disc | 1 Silicone hose |
| | 1 Storage case |

Greenhouse Effect Kit (230 V, 50/60 Hz)

P-1000837

Greenhouse Effect Kit (115 V, 50/60 Hz)

P-1009764

- Additionally required:
P-1000824 Moll-Type Thermopile
Butane (lighter gas)
P-1001028 Measuring Amplifier S
P-1000866 Transformer 12 V (230 V, 50/60 Hz)
 or
P-1000865 Transformer 12 V (115 V, 50/60 Hz)
P-1013527 Analogue Multimeter ESCOLA 100
 Alternative:
P-1001022 Measuring Amplifier (230 V, 50/60 Hz)
 or
P-1001021 Measuring Amplifier (115 V, 50/60 Hz)
P-1002781 Digital Multimeter P1035

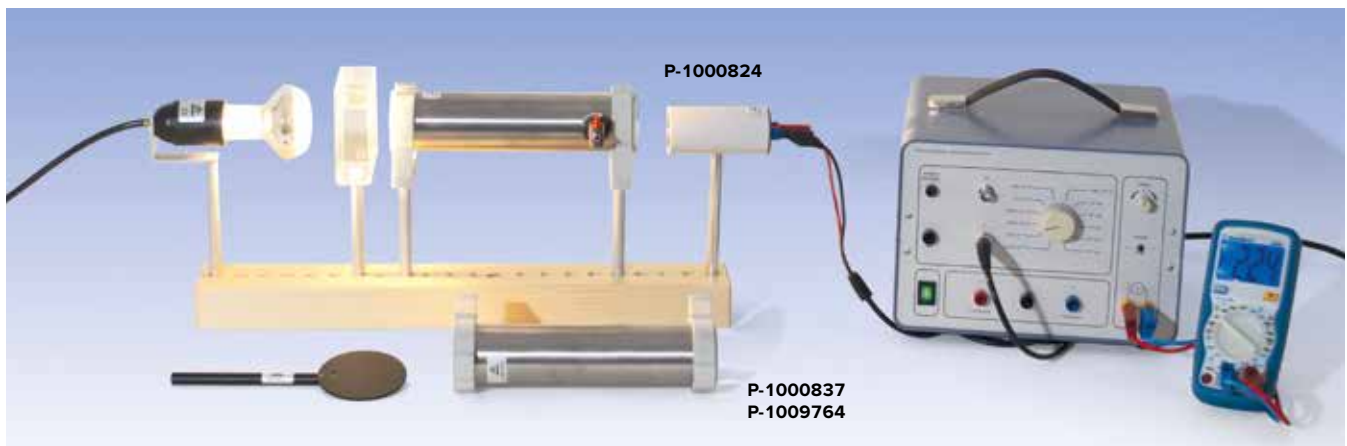



P-1002877

Precision Hair Hygrometer

Hygrometer for measuring the relative air humidity, consisting of a round plastic housing with a synthetic hair as the measuring element. The specially treated hair exhibits an almost inertia free response to changes in humidity. Wall mountable.

- Measuring range: 0% – 100% relative humidity
- Temperature range: -35° C – +65° C
- Reading accuracy: ± 5%
- Diameter: 100 mm

P-1002877

P-1003011



Digital Hygro-Thermometer

Digital measuring device for displaying exterior and interior temperature and humidity. With min/max function and acoustic signal if exterior temperature drops to or below zero, switchable between °C and °F, on/off button, eyelet for hanging up and fold-out stand.

- Measuring range:
- Temperature (interior): 0° C – +50° C / 32° F – +122° F
- Temperature (exterior): -50° C – +70° C / -58° F – +158° F
- Humidity: 20% – 99%
- Divisions: 0.1° C/F, 1%
- Accuracy (temp.): ±1° C / ±2° F
- Accuracy (humidity): ±3%
- Exterior temperature sensor: Cable length 3 m

P-1003011

P-1002795



Infra-red Temperature and Humidity Gauge

Digital measuring device for contact-free temperature measurement from large distances, e.g. of hot or moving objects or inaccessible points of measurement, and for simultaneous humidity display. With laser diode as detection aid, integrated in the measuring probe, illuminated LCD display, max and data-hold function, switchable between °C and °F, automatic switch-off. Includes pouch and battery.

- Measuring range, temperature: -50° C – +500° C; -58° F – +932° F
- Divisions: 0.1° C/F
- Accuracy: ±2% of measured value ±2° C / 4° F
- Measuring range, humidity: 5% – 95%
- Divisions: 0.1%
- Accuracy: ±3.5%
- LCD dual-function display: 3½-digit, 21 mm with backlighting
- Voltage supply: 9 V battery
- Dimensions: approx. 90x170x45 mm³
- Mass: approx. 360 g

P-1002795

Demonstration Aneroid Barometer

Barometer for measuring air pressure and demonstrating how an aneroid barometer operates. The measurement system consists of two flat, highly-evacuated metal cans which deform in response to changes in the air pressure. This deformation is indicated by a pointer. The pointer mechanism and metal cans are situated behind a glass cover for easy observation. By pumping the attached rubber ball the action caused by the air pressure changes can be demonstrated.

- Measuring ranges: 955 – 1070 mbar, scale division 1 mbar
- 715 – 800 mmHg, scale division 1 mmHg
- Scale diameter: 120 mm
- Housing diameter: 130 mm
- Weight: 650 g

P-1002627



Maximum-Minimum Thermometer

Reading of maximum, minimum and instantaneous temperature. In plastic housing with reset button and hanging strap. Red alcohol filling.

- Measuring range: -43° C – +50° C
- Divisions: 1° C
- Dimensions: approx. 230x85 mm²

P-1011450



P-1011450

Digital Pocket Anemometer

Waterproof anemometer for measuring wind speed. Indication of wind chill temperature based on the combination of air temperature and wind speed. Indication of mean and maximum speeds. Wind curves on the Beaufort scale. Supplied with closeable cover.

Wind speed: 0.2 – 30 m/s
 Accuracy: ±5% of mean wind speed
 Units: km/h, m/h, m/s or knots
 Temperature: -30° – +59°C
 Battery: 3.0 V (CR2032)
 Dimensions: 137x50x18 mm³

P-1010250



P-1010250

Aneroid Barometer F

Aneroid Barometer in a metallic box with altitude adjustment screw at the rear. Graduations in mm of mercury and hPa. Diameter of the dial: 98 mm

P-1010232



P-1010232

Wireless Weather Station

Weather station with wireless detection of external temperatures from up to three sensors situated at distances of up to 25 m. Display of internal temperature and humidity. Features switchable °C/°F display, min/max function, weather forecasting, trend displays for air pressure and radio-controlled clock with date function. Supplied with one external temperature sensor, two 1.5-V AA batteries and two 1.5-V AAA batteries. Silver/grey housing. Can be suspended or set up on a surface.

External temperatures: -30°C – +70°C
 Internal temperatures: 0°C – +60°C
 Humidity: 1 – 99%

P-1010248



P-1010248

Noise: the World's no. 1 Pollutant

Noise

- Damages hearing
- Makes it more difficult to hear genuinely important signals
- Impedes both physical and mental work
- Disturbs and adversely affects well being
- Disturbs relaxation and sleep
- Can cause chronic stress, physical ailments and illness



P-1012741

Noise Level Indicator SPL

Handy and easy-to-use noise level meter with digital display in decibels (dB) and an arbitrarily adjustable trigger threshold for use as a traffic-light style noise indicator with a happy green face and a sad red face. Can be mounted on a wall or set up on a table top. Its well-conceived compact design makes it easy to transport. Automatically switches to electricity-saving stand-by mode when noise is low for a long period. The brightness of the display can also be adjusted. Includes a stand base, USB/miniUSB cable, USB power supply and transport case.

Display: 100 mm diam, with LED
 Measuring range: 40 dB – 130 dB
 Resolution: 1dB
 Thresholds for colour display: Adjustable to any level in steps of 1 dB
 Power supply: 5 V DC via miniUSB socket
 Power consumption: 150 mA (normal operating mode)
 <1 mA (stand-by)
 USB power supply: 100 – 240 V, 50/60 Hz
 Dimensions: 130x145x12 mm³
 Weight: 400 g approx.

P-1012741





Thermometer Clip
Stainless steel clip for holding thermometers in beakers.

P-1003528



P-1003527

P-1002881

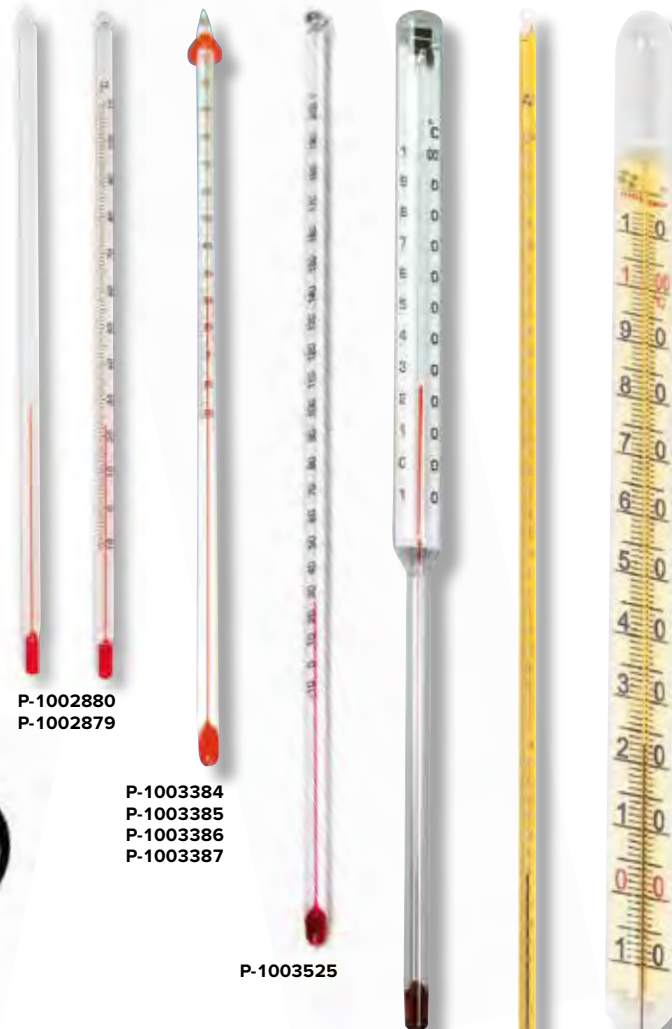

P-1002880
P-1002879

P-1003384
P-1003385
P-1003386
P-1003387

P-1003525

P-1003526



P-1000551

P-1000550

Temperature Sensor, Pt100

Temperature sensor for the measurement of temperatures in organic liquids, solutions of salts, acids, and bases. The stem and tip of the temperature sensor are of stainless steel. Can be used in conjunction with 3B NET/log™ unit (P-1000540 or P-1000539) for manual measurements or for processing measurement data when connected to a computer. Includes connector lead with 8 pin miniDIN plugs.

Measurement range: $-50^{\circ}\text{C} - 150^{\circ}\text{C}$
Resolution: 0.1°C
Accuracy: 0.1% of measured value plus 0.25°C
Sensor cable: 1 m, with silicone insulation
Sensor type: Pt100 thermocouple

P-1000550



P-1002804

P-1002805

P-1003013

P-1003014

Temperature Sensor, TC – K

Temperature sensor for the measurement of extremely low and extremely high temperatures, for example in liquid nitrogen or liquid oxygen, or inside a flame. With room temperature compensation. The immersible NiCr-Ni sensors (P-1002804 and P-1002805) can also be connected to the sensor box. Can be used in conjunction with a 3B NET/log™ unit (P-1000540 or P-1000539) for manual measurements or for processing measurement data when connected to a computer. Includes connector lead with 8 pin miniDIN plugs.

Measurement range: -270°C to 400°C
Accuracy: 0.2% plus 3°C ($-270^{\circ}\text{C} - 0^{\circ}\text{C}$)
 0.1% plus 2°C ($0^{\circ}\text{C} - 400^{\circ}\text{C}$)
Resolution: 1°C
Sensor type: NiCr-Ni (type K)
Sensor length: 60 cm approx.

P-1000551

K-Type NiCr-Ni Immersion Sensor, -65°C to 550°C

Temperature measurement sensor with stainless steel (V4A)-tube, spring-mounted (rigid) and silicone cable.

Measuring range: $-65^{\circ}\text{C} - 550^{\circ}\text{C}$
Response time: approx. 3 s
Tube: 130 mm x 1.5 mm diam.

P-1002804

K-Type NiCr-Ni Immersion Sensor, -200°C to 1150°C

Sheath thermocouple with stainless steel (Inconel) tube, flexible and silicone cable.

Measuring range: $-200^{\circ}\text{C} - 1150^{\circ}\text{C}$
Response time: approx. 3 s
Tube: 150 mm x 1.5 mm diam.

P-1002805

Art. No.	Scale division	Measuring range	Scale division	Dimensions	Remarks
P-1003527	Thermometer	+10° – 30°C	0.2°C	140 mm x 6 mm diam.	Tube type, white coated capillary, red alcohol filling.
P-1002881	Pocket Thermometer	-10° – 110° C	1° C	165 mm x 10 mm diam.	Tube type, scale on white background, special red filling, in yellow plastic protective case with clip.
P-1002879	Tube Thermometer, graduated	-10° – 110° C	1° C	260 mm x 6 mm diam.	Glass thermometer with eyelet, scale on white background, special red filling, in transparent square plastic case.
P-1002880	Tube Thermometer, not graduated	–	–	260 mm x 6 mm diam.	For demonstrating function and mode of operation of thermometers. Like P-1002879 but without scale.
P-1003384	Thermometer	-20° – 110° C	1° C	295 mm x 6.3 mm diam.	Tube type with anti-roll design, white coated capillary, red alcohol filling, packed in a plastic tube.
P-1003385	Thermometer	-10° – 150° C	1° C	295 mm x 6.3 mm diam.	Tube type with anti-roll design, white coated capillary, red alcohol filling, packed in a plastic tube.
P-1003386	Thermometer	-20° – 110° C / 0° – 230° F	1° C/F	295 mm x 6.3 mm diam.	Tube type with anti-roll design, white coated capillary, red alcohol filling, packed in a plastic tube.
P-1003387	Thermometer	-20° – 150° C / 0° – 300° F	1° C/F	295 mm x 6.3 mm diam.	Tube type with anti-roll design, white coated capillary, red alcohol filling, packed in a plastic tube.
P-1003525	Thermometer	-10° – 200° C	1° C	300 mm x 6 mm diam.	Rod-shaped general-purpose thermometer, white-coated capillary, red indicator liquid, total immersion depth.
P-1003526	Rod Thermometer	-10° – 100° C	1° C	350 mm x 8 mm diam., Length of rod: 150 mm	Rod thermometer with internal scale made of frosted glass, prismatic capillary tube and red liquid.
P-1003013	Stable Tube Type Thermometer	-1° – 101° C	0.2° C	460 mm x 7 mm diam.	Stable tube type thermometer with biodegradable special blue filling, scale on yellow background, with eyelet.
P-1003014	Demonstration Thermometer	-10° – 110° C	1° C	650 mm x 30 mm diam.	Extra-large tube type thermometer with biodegradable special blue filling, easy-to-read scale on yellow background.

Digital Quick-Response Pocket Thermometer

For instantaneous measurements on surfaces, in liquids, soft plastic media, air/gases, very small objects. For connection to a K-type NiCr-Ni measurement sensor. Sensor not included in scope of supply.

Measuring range: -65° C – 1150° C / -85° F – 1999° F in 2 ranges

Division: 0.1° C / 1° C/F

Accuracy in

lowest range: 0.05% of measured value ±0,2% FS

Display: 3½-digit LCD display, 13 mm in height

Dimensions: 106x67x30 mm³

Mass: approx. 135 g

P-1002803

Additionally required:

P-1002804 K-Type NiCr-Ni Immersion Sensor, -65° C to 550° C

or

P-1002805 K-Type NiCr-Ni Immersion Sensor, -200° C to 1150° C

P-1002803





P-1010219

Insertion Thermometer

For measuring the temperature in air, liquids and soft materials. Temperature sensor made of stainless steel with protective case, switchable between °C and °F, On/Off switch and automatic switch-off.

- Measuring range: -50° C – 150° C / - 58° F – 302° F
- Division: 0.1° C/F
- Accuracy: ±1° C / ±2° F
- Temperature sensor: 130 mm x 4 mm diam.
- Mass: 29 g

P-1003334



P-1003334

Insertion Thermometer F

Waterproof digital thermometer with a 125 mm long sensor to measure the temperature of liquid, pulverulent and soft substances. With memory function, min/max function, reversible °C/°F. Plastic casing, clip and LR 44 button battery included.

- Measuring range: -40 – +200°C
- Accuracy: ±0.8 degree (from 0 – 100°C), ±1 degree (from -20 – 0°C), ±1.5 degree (others)

- Measurement interval: 1 s
- Dimensions: 205x20x17 mm³
- Mass: 56 g

P-1010219

Digital Thermometer, Min/Max

Insertion thermometer with Hold and Min/Max function in robust plastic housing and temperature sensor made of stainless steel. Switchable between °C and °F, On/Off switch, hanging strap and folding angled support.

- Measuring range: -50° C – 200° C / -58° F – 392° F
- Division: 0.1° C/F
- Dimensions: 95x65x20 mm³
- Cable length: 1400 mm
- Measurement probe: 120 mm

P-1003010



P-1003010

Digital Pocket Thermometer

Temperature sensor made of stainless steel with protective case, watertight, switchable between °C and °F, Min/Max/Hold function, automatic switch-off.

- Measuring range: -40° C – 200° C / -40° F – 392° F
- Division: 0.1° C/F
- Accuracy: ±1° C / ±2° F
- Dimensions: 150x20x18 mm³
- Mass: 20 g

P-1003335



P-1003335

Infra-red Thermometer

Surface thermometer for contactless temperature measurement from a safe distance, e.g. in inaccessible places, hot or moving objects. With laser diode for laser sighting, illuminated LCD display, range overflow display, measured value storage function, selection between Celsius and Fahrenheit, automatic switch off. Includes bag and battery.

	P-1002791	P-1008630
Designation	Infra-red Thermometer, 800° C	Infra-red Thermometer, 380° C
Measuring range	-50° C – +800° C -58° F – +1472° F	-50° C – 380° C -58° F – 716° F
Division	0.1° C/F	1° C/F
Accuracy	±1% of measured value ±1° C / 1.8° F	2% of measured value +2° C / 4° F
Response time	150 ms	< 1 s
Optical resolution	20:1	12:1
Max. temperature display	yes	–
Alarm function	high/low	–
Voltage supply	9 V battery	9 V battery
Dimensions	146x43x104 mm ³	160x82x45 mm ³
Mass	approx. 170 g	approx. 180 g



P-1002799

Thermometers

Digital Thermometer Type K/IR

Digital two channel thermometer with two K- type inputs and additional external infra-red sensor. Can also be used for measurements at low temperatures. With automatic shut off, maximum value storage and data hold function. Includes case, 2 K-type thermocouple sensors, infra-red temperature sensor, 9 V battery and instruction manual.

- Measurement inputs: 2x K-type, external IR input
- Measuring functions: T1, T2, T3, T1-T2, T1-T3, T2-T3
- Measuring range: -200 – 1372°C (type K), -30 – 550°C (IR)
- Measurement error: ±0.5% + 2°C (type K), ±2.5% +2°C (IR)
- Resolution: 0.1°C
- Unit of measurement: °C or K
- Emission factor: 0.95 fixed
- Digital display: 3¾ digit LCD
- Background lighting: blue
- Operating voltage: 9 V battery
- Dimensions: 75x200x50 mm³ approx.
- Mass: 280 g approx.

P-1002799



P-1002791

P-1008630

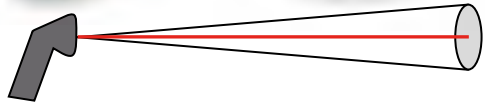

	P-1002793	P-1002794
Designation	Digital Thermometer, 1 Channel	Digital Thermometer, 2 Channels
Measuring range	-50° C – +1300° C -58° F – +2000° F 223 K – 2000 K	-50° C – +1300° C -58° F – +2000° F
Division	0.1° C/F, 1 K	0.1° C/F
Accuracy	±0.5% +1° C / +2° F ±1% +2 K	±0.5% +1° C / +2° F
Display	3½-digit illuminated LCD	3½-digit illuminated LCD
Digit size	21 mm	21 mm
Voltage supply	9 V battery	9 V battery
Dimensions	approx. 90x170x45 mm ³	approx. 90x170x45 mm ³
Mass	approx. 350 g	approx. 350 g

Digital Thermometer

Versatile digital thermometer for type-K temperature sensors with single or dual input (P-1002794) for measuring instantaneous or differential temperature T1 – T2 (P-1002794). With storage of maxima and Data-Hold function. Includes type-K temperature sensor (P-1002794 2x), battery, holster and carrying bag.



P-1002793 / P-1002794

Heat and Thermodynamics

Heat Equivalent Apparatus

Apparatus for determining the specific heat capacity of aluminium and for confirming the energy conservation law. The robust heat equivalent apparatus consists of a shaft with ball bearings at both ends, an integrated counter for measuring the number of revolutions performed and an attached table clamp for securing the device. The aluminium calorimeter body heats up as a result of frictional work or electrical energy from the integrated heating element. An NTC thermistor, acting as a temperature sensor and located in an aluminium case, determines the temperature. The calculation can be performed easily using the temperature calibration table printed on the apparatus.

- Length: 230 mm
- Span of the table clamp: 10 – 65 mm span
- Cord length: approx. 1.80 m
- Calorimeter body: 50 mm x 48 mm diam.
- Electric heater power: 10 V, 1 A
- Weight calorimeter: 250 g
- Total mass : approx. 1200 g

Contents:

- 1 Basic unit
- 1 Aluminum calorimeter
- 1 Temperature sensor
- 1 Pair of adaptor cables with 4 mm safety plugs/2 mm plugs
- 1 Friction belt
- 1 Bucket, 5 l
- 1 Counterweight

P-1002658

Additionally required for temperature measurement:

P-1002781 Digital Multimeter

Additionally recommended:

P-1003312 DC Power Supply, 0 – 20 V, 0 – 5 A (230 V, 50/60 Hz)

or

P-1003311 DC Power Supply, 0 – 20 V, 0 – 5 A (115 V, 50/60 Hz)

P-1002659 Copper Calorimeter

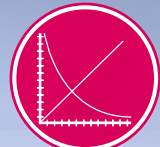
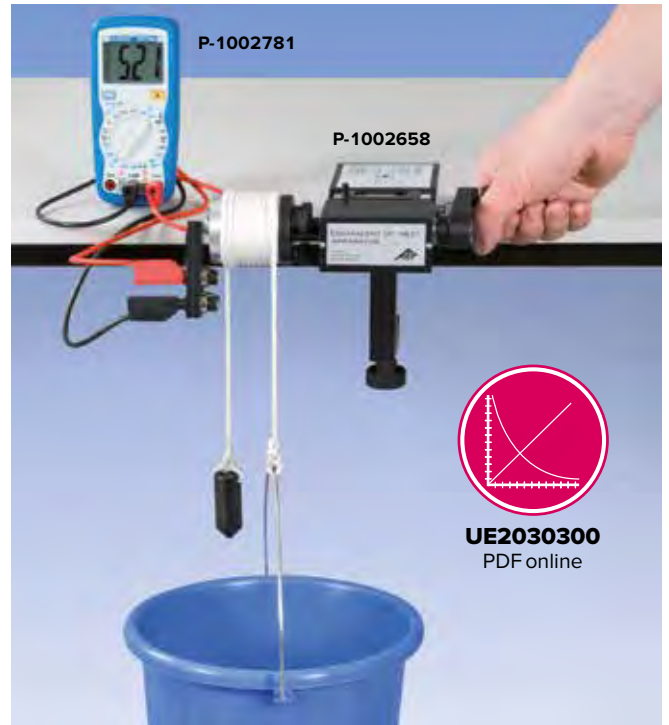

UE2030300
PDF online

Calorimeter Bodies

Calorimeter bodies for the heat equivalent device and for determining the specific heat capacity. With borehole for holding temperature sensor and with integrated heating element.

- Electric heater power: 10 V, 1 A
- Heating element connection: via 2-mm sockets
- Dimensions: approx. 50 mm x 48 mm dia.
- Weight: approx. 750 g (Cu) / 250 g (Al)

Copper Calorimeter

P-1002659

Aluminium Calorimeter

P-1017897

Temperature Sensor

Temperature sensor (NTC thermistor) for use with calorimeter bodies (P-1002659 and P-1017897).

P-1017898

Pair of Adapter Cables with 4 mm Safety Plugs/2 mm Plugs

Cables for connection to contacts of heating elements in calorimeter bodies (P-1002659 and P-1017897).

P-1017899

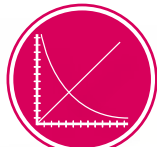

UE2030400
PDF online

Calorimeter, 200 ml

For determining temperatures of mixtures, specific heat capacities, conversion energies of substances and heat of fusion of ice. Designed for simple experiments for students. Plastic container with styrofoam inlay.

- Capacity of insulated container: approx. 200 ml
- Weight: approx. 80 g

P-1000823

Additionally required:

P-1003526 Tube Thermometer, -10 – +100° C

Additionally recommended:

P-1000832 Aluminium Shot, 100 g

P-1000833 Copper Shot, 200 g

P-1000834 Glass Shot, 100 g



P-1000823



Calorimeter with Heating Coil, 150 ml

For determining the specific heat capacity of solids and liquids and for measuring the electric heat equivalent. Two mutually insulated aluminum beakers, lid with rubber stopper with boreholes for thermometer and stirrer, with heating coil.

Capacity of insulated container: 150 ml
 Connection sockets: 4 mm
 Electric heater: 6 V/2 A max.

P-1000822

Additionally required:
P-1002879 Tube Thermometer, -10 – +110°C

Additionally recommended:
P-1000832 Aluminium Shot, 100 g
P-1000833 Copper Shot, 200 g
P-1000834 Glass Shot, 100 g
P-1003312 DC Power Supply, 0 – 20 V, 0 – 5 A (230 V, 50/60 Hz)

or
P-1003311 DC Power Supply, 0 – 20 V, 0 – 5 A (115 V, 50/60 Hz)

Immersion Heater, 12 V

Sheathed heater suitable for the metal block calorimeters (from P-1003253).

Operating voltage: max. 12 V
 Power: max. 50 W (nominal)
 Tubing: 150 mm long
 Heated section: 70 mm
 Electrical connection: 4 mm sockets

P-1003258

Set of 4 Calorimeter Cylinders

Four cylindrical metal calorimeter blocks, each of mass 1 kg, for determining the specific thermal capacities of aluminium, brass, copper and steel. Each calorimeter cylinder has two holes for inserting a heating element (P-1003258) and a thermometer or temperature sensor.

Hole for heating element: 12.5 mm diam.
 Hole for thermometer: 8 mm diam.

P-1003253

Additionally required:
P-1003258 Immersion Heater, 12V Thermometer or Temperature Sensor

Calorimeter with Heating Coil, 1,200 ml

Calorimeter for determining specific heat capacities, conversion energies of materials, mixing temperatures as well as measurement of electrical equivalents of heat. Consists of a double-walled, heat-insulating plastic container with an insulating vessel inside made of reflecting glass, with heating coil and stirrer. Also includes a lid with an opening for a thermometer and two 4 mm plugs for connecting the power supply for the heating coil. The calorimeter is equipped with a heating filament, electrically insulated to avoid decomposition of filament and terminals due to electrolytic processes.

Max. heater voltage: 25 V
 Max. heating power: approx. 160 W
 Contents of insulated container: approx. 1200 ml
 Dimensions: approx. 240 mm x 120 mm diam.
 Weight: approx. 0.8 kg

P-1000821

Additionally required:
P-1003526 Tube Thermometer, -10 – +100°C

Additionally recommended:
P-1000832 Aluminium Shot, 100 g
P-1000833 Copper Shot, 200 g
P-1000834 Glass Shot, 100 g
P-1003312 DC Power Supply, 0 – 20 V, 0 – 5 A (230 V, 50/60 Hz)

or
P-1003311 DC Power Supply, 0 – 20 V, 0 – 5 A (115 V, 50/60 Hz)

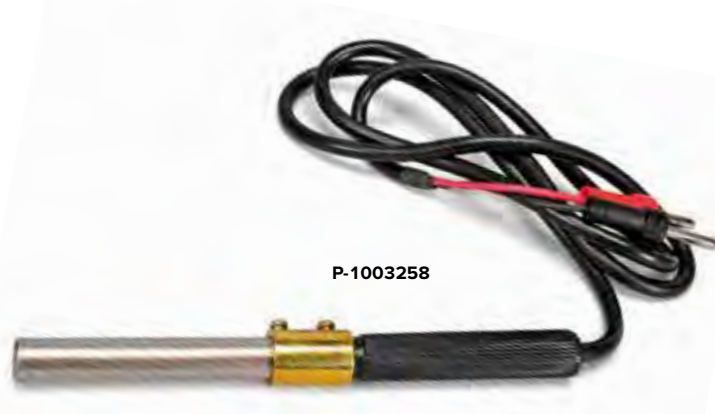

Additionally required:
P-1003312 DC Power Supply Unit 0 – 20 V, 0 – 5 A (230 V, 50/60 Hz)

or
P-1003311 DC Power Supply Unit 0 – 20 V, 0 – 5 A (115 V, 50/60 Hz)

Art. No.	Material	Height	Dia-meter	Specific heat J/(kg*K)
P-1003254	Aluminium	84 mm	75 mm	896
P-1003255	Brass	84 mm	44 mm	377
P-1003256	Copper	85 mm	43 mm	385
P-1003257	Steel	92 mm	44 mm	452





Demonstrate the forces resulting from changes in length arising from heat or cold. These forces are sufficient to break a 10-mm iron bolt.

Tyndall's Bar Breaker
 U-shaped clamping set up with a metal rib and fastening screw for demonstrating the linear expansion of metals on heating, as well as the tremendous forces which can be exerted in the process. The set includes 10 cast-iron bolts for breaking in the course of the experiment.
 Diameter for bolt hole: approx. 11 mm
 Length of clamping fixture: approx. 285 mm
 Weight: approx. 1400 g

P-1000829

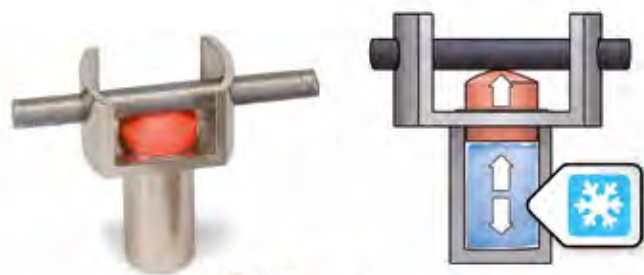
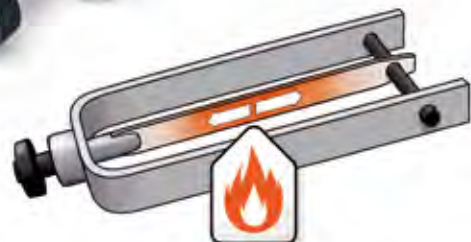

Ball and Ring
 Brass ball and brass ring with plastic handles for demonstrating the thermal expansion of solid bodies. After heating in a burner flame, the ball no longer fits through the cold ring.
 Length: approx. 250 mm

P-1003382

Cast Iron Bolts, Set of 10 Bolts
 Spare bolts to be used with Tyndall's bar breaker (P-1000829) or the ice bomb (P-1000828).

P-1000827



Ice Bomb
 Clamping set up for demonstrating volumetric expansion of water on freezing, as well as the tremendous forces which can be exerted in the process. Comprises a steel cylinder with a clamping rib and plastic lid. The set includes 10 cast-iron bolts for breaking in the course of the experiment.

Diameter for bolt hole: approx. 11 mm
 Dimensions: approx. 40x30x75 mm³
 Weight: approx. 620 g

P-1000828

Ball with Ring
 An arrangement for demonstrating the expansion of solids on heating. After heating in a burner flame, the ball no longer fits through the bore in the bracket. Steel ball with chain and handle.

Dimensions of the bracket in mm: approx. 40x50x40 mm²
 Diameter of ball: approx. 22 mm
 Length of handle with shaft: approx. 225 mm
 Weight: approx. 175 g

P-1000831



Linear Expansion Apparatus with Three Pointers

Apparatus for measuring the linear expansion of different kinds of solids simultaneously. The set includes three sample tubes (brass, aluminium and glass) which are heated by passing steam through them. Linear expansion is indicated on a mirror scale by three differently coloured pointers mounted on rollers. Includes silicone tubing. Dimensions of the tubes: 700 mm x 6 mm diam. Dimensions: approx. 830x80x70 mm³ Weight: approx. 1.2 kg

P-1000830

Additionally required:

P-1001049 Steam Generator (230 V, 50/60 Hz)

or

P-1006769 Steam Generator (115 V, 50/60 Hz)

Steam Generator

Device for generation of steam, e.g. in experiments on thermal expansion. Aluminum vessel with cork lid and retainer on an adjustable hot plate with a thermal circuit breaker.

Hotplate: 90 mm diam.
 Power consumption: 550 W
 Vessel volume: 250 ml
 Dimensions: 170 mm x 180 mm diam.
 Hose connection: 6 mm diam.
 Total mass: approx. 1 kg

Steam Generator (230 V, 50/60 Hz)

P-1001049

Steam Generator (115 V, 50/60 Hz)

P-1006769

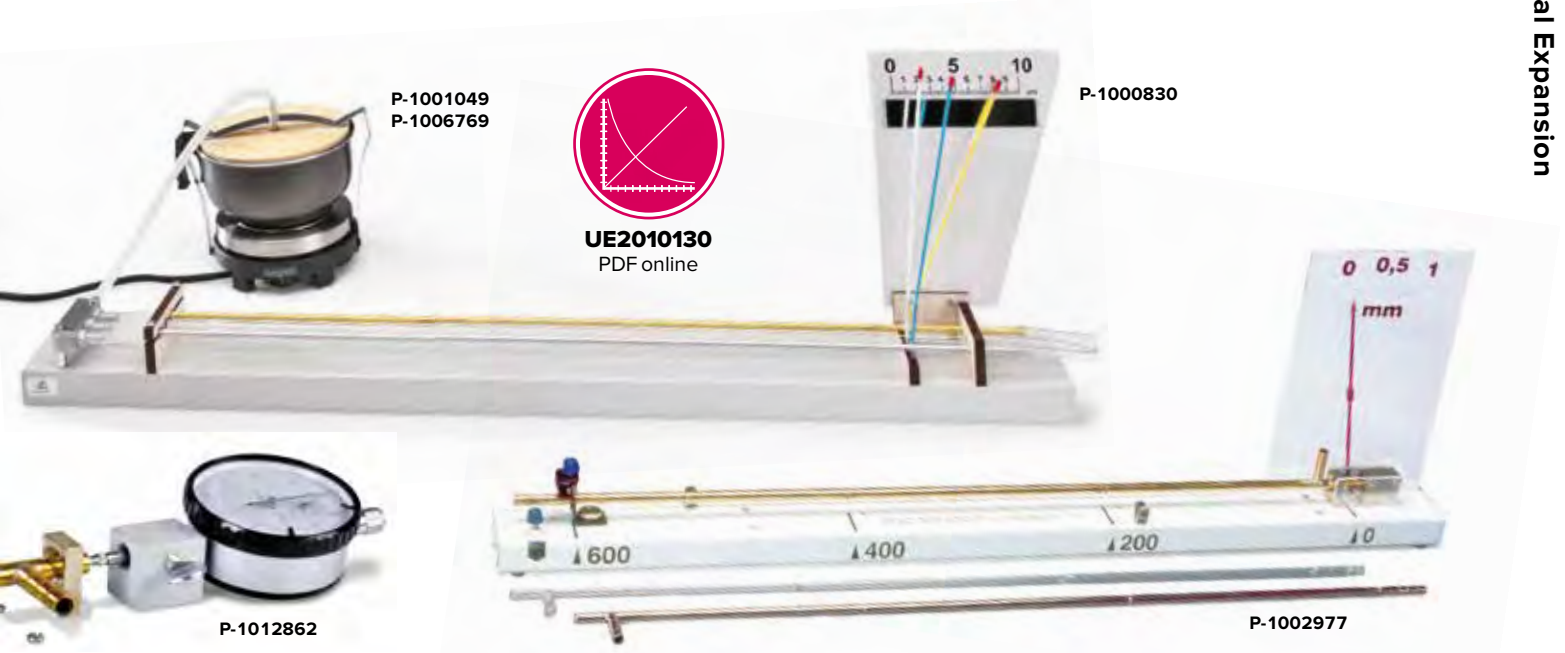

Gauge with Adapter

Analogue gauge for measuring minimal changes in length plus an adaptor for fitting a gauge dial as an enhancement to the extension apparatus D (P-1002977).

P-1012862

Linear Expansion Apparatus S

A device for measuring the linear expansion of solids as a function of length and material. Includes three sample tubes (iron, copper and glass) which are heated by passing water vapour through them. Consists of a base strip with a clamping spring, pointer, scale and hose nipple.

Pointer ratio: 1:50
 Tube length: approx. 630 mm
 Dimensions: 530x60x240 mm³
 Weight: 0.6 kg

P-1002978

Additionally required:

P-1001049 Steam Generator (230 V, 50/60 Hz)

or

P-1006769 Steam Generator (115 V, 50/60 Hz)

P-1002622 Silicone Tubing, 1 m

Linear Expansion Apparatus D

A device for measuring the linear expansion of solids as a function of length and material. Includes three sample tubes (steel, brass and glass) which are heated by passing water vapour through them. Consists of a base strip with a fixed bearing, pilot bearing, pointer and projectable scale.

Scale dimensions: 140x200 mm²
 Measuring range: 1 mm
 Reading accuracy: 0.05 mm
 Tube length: approx. 650 mm
 Dimensions: approx. 730x50x200 mm³
 Weight: approx. 2 kg

P-1002977

Additionally required:

P-1001049 Steam Generator (230 V, 50/60 Hz)

or

P-1006769 Steam Generator (115 V, 50/60 Hz)

P-1002622 Silicone Tubing, 1 m

Additionally recommended:

P-1012862 Gauge with Adapter



Experiment Topics:

- Thermal anomaly
- Density maximum



UE2010301
PDF online

P-1002889

P-1002804

P-4000036

P-1002793

P-1002808

Device for Demonstrating the Anomaly of Water

Apparatus for demonstrating the thermal anomaly of water, measuring its thermal expansion and determining its maximum density. Consists of a Duran glass vessel with an inlet tube and two GL screw connections for mounting the riser tube with a mm scale and a thermometer. Includes stirring rod.

- Volume: 250 ml
- Riser tube: 400 mm
- Capillary: 1.5 mm diam.
- Hose nipple: 8 mm
- Overall height: approx. 500 mm

P-1002889

Additionally required:

- P-4000036 Plastic Trough**
- P-1002808 Magnetic Stirrer**
- P-1003013 Tube Thermometer**
- or
- P-1002793 Digital Thermometer**
- and
- P-1002804 K-Type NiCr-Ni Immersion Sensor, -65°C – 550°C**

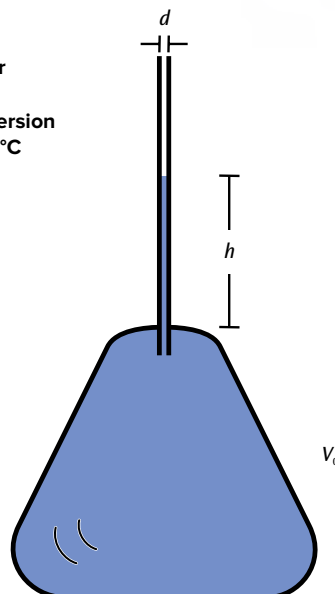

Vessel with riser tube

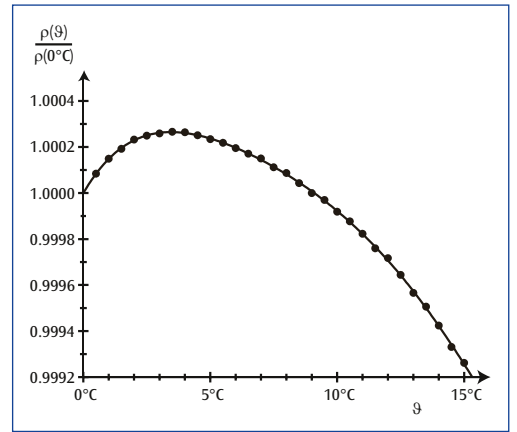

Determining the maximum density of water

P-1018001

P-1003511



Gas Expansion Apparatus

Glass vessel with ground-glass sealing joints for demonstrating the expansion of air when heated. The U-tube is filled with water at room temperature and the water levels are marked. Even the heat from a hand is enough to cause the air in the flask to expand so that the water levels in the U-tube change visibly.

P-1003511

Volume Dilatometer

Glass vessel for investigating changes in volume in a liquid as a function of temperature and for determining volumetric expansion coefficients. With ground graduated riser tube.

- Volume: 50 ml
- Length of riser tube: 120 mm
- Scale: mm scale

P-1018001

Heat-Flow Device

Stable glass flask with rectangular bends for demonstrating the flow of heat in a liquid that is heated non-uniformly. With GL 18 screw fitting and side-limbs for filling with water, and a small quantity of potassium permanganate for colouring.

Dimensions: 420x420 mm²
 Tube diameter: 30 mm

P-1002903

Additionally required:

- P-1002836 Tripod Stand, 185 mm**
- P-1002934 Stainless Steel Rod, 470 mm**
- P-1002830 Universal Clamp**
- P-1002833 Universal Jaw Clamp**
- P-1003565 Spirit Lamp**
- Potassium permanganate for use as a colouring agent**

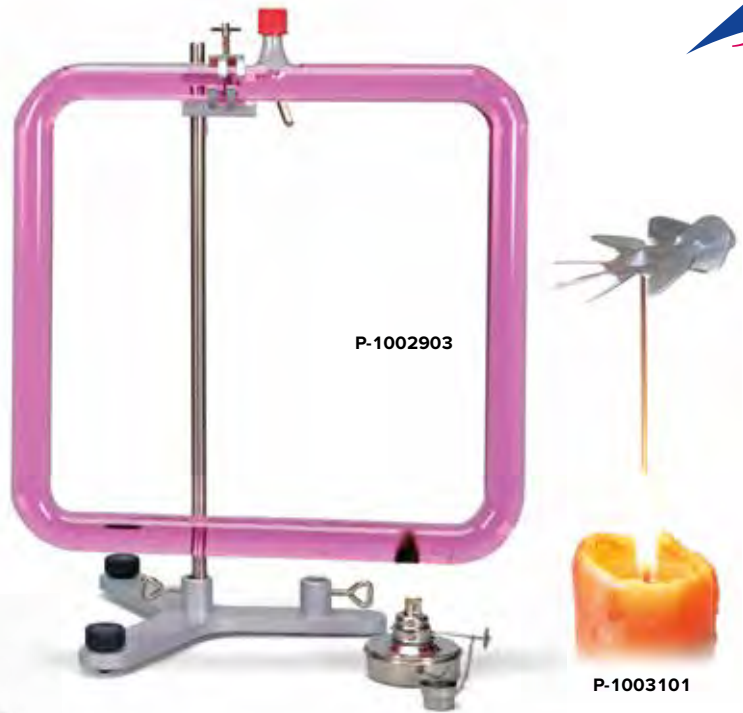

Heat-Flow Device S

Stable glass flask on a stand for demonstrating the flow of heat in a non-uniformly heated liquid. With filling hole for filling with water and a small quantity of potassium permanganate crystals for colouring.

Glass flask: 300x150 mm²
 Tube diameter: 14 mm
 Height: 250 mm

P-1003512

Additionally required:

- P-1003565 Spirit Lamp**
- Potassium permanganate for use as a colouring agent**

Vane Wheel

Device for demonstrating air and heat flows generated by a burning candle, water vapour or other heat sources. Made of Aluminium and mountable on a long needle.

P-1003101

Additionally required:

- Long needle**

Heat Conductivity Device

A device with five metal bars for comparing the thermal conductivity of aluminium, brass, steel, zinc and copper – by melting wax balls at the rod ends. The five rods extend in a star-shaped configuration from a brass hub. Each rod has a notch for holding wax.

Length: 340 mm

P-1003383



Thermal Conductivity Equipment Kit

Kit for the qualitative investigation of the heat conductivity of Aluminium (extremely high thermal conductivity) and expanded polystyrene (very low thermal conductivity). Even at room temperature the varying material temperatures are evident to the touch. In the experiment ice cubes are placed on the plates. The ice cube on the seemingly colder Aluminium plate melts much more quickly (in 1 – 2 minutes), while there seems to be no melting at all of the ice cube on the seemingly warmer plastic plate. Two rubber rings which prevent the ice cubes from slipping off the plates complete the experiment kit.

Plate dimensions: approx. 95x95x13 mm³

P-1003497





P-1000824

Moll Type Thermopile

Sensitive probe for measuring heat radiated by a black body or Leslie's cube, as well as for detecting visible light and ultraviolet radiation. Comprises a metal housing with a polished, conical reflector and a black surface 15 mm in diameter with 17 linked thermocouples.

With two 4 mm connectors mounted on a stem.

Sensitivity: approx. 0.14 $\mu\text{V}/\mu\text{W}$

Internal

resistance: approx. 1 Ω

Setting duration: 40 s for 95% of the measured value

Rod: 156 mm x 10 mm diam.

Dimensions: 94 mm x 40 mm diam.

Weight: approx. 200 g

P-1000824

Additionally required:

P-1013527 Analogue Multimeter ESCOLA 100

P-1001046 Barrel foot

2 Experiment leads

Equipment:

P-1000835 Leslie's Cube

P-1017875 Rotating base for Leslie cube

P-1000824 Moll Type Thermopile

P-1002785 Digital Multimeter P3340

P-1002803 Digital Quick Response Pocket Thermometer

P-1002804 K-Type NiCr-Ni Immersion Sensor, $-65^{\circ}\text{C} - 550^{\circ}\text{C}$

P-1002849 Pair of Safety Experiment Leads, 75 cm

P-1002748 HF Patch Cord, BNC/4 mm Plug

P-1001046 Barrel Foot, 500 g (2x)

P-1002603 Pocket Measuring Tape, 2 m

P-1001022 Measurement Amplifier (230 V, 50/60 Hz)

or

P-1001021 Measurement Amplifier

(115 V, 50/60 Hz)



UE202020
PDF online

Leslie's Cube

A hollow aluminium cube for investigating heat radiation from a hot body as a function of its temperature and surface. With a removable lid for pouring in hot water and 2 openings for inserting a thermometer or thermal sensor and a stirrer. One side each is polished, matte, black and white.

Dimensions: 100x100x100 mm^3

Weight: approx. 360 g

P-1000835

Additionally required:

P-1000824 Moll Type Thermopile



P-1000835

Rotating Base for Leslie Cube

Plastic platform for Leslie Cube. With rotating bearing on stand rod. Includes felt strips for thermal insulation purposes.

Dimensions: 100x100 mm

Stand rod: 120 mm x 10 mm diam.

P-1017875



P-1017875

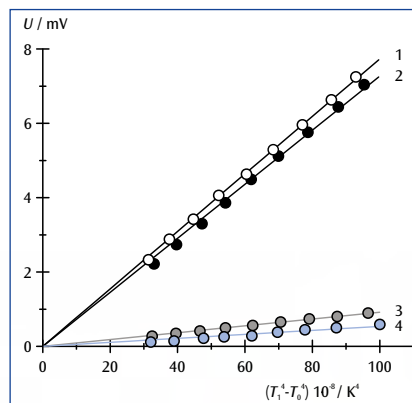

- 1: White surface
- 2: Black surface
- 3: Matte surface
- 4: Shiny surface

Radiated intensity from a Leslie Cube as a function of $x = T^4 - T_0^4$



Measure the heat radiated by a Leslie Cube

P-1000835

Experiment Topics:

- Introduction to thermal radiation
- Stefan-Boltzmann law



P-1017730
P-1017729

Leslie Cube with Heater

Hollow cube made of aluminium for quantitative analysis of thermal radiation from a hot body as a function of temperature and the nature of the surface. Rotatable cube with built-in 150-W lamp and integrated temperature sensor for regulated heating of surfaces to a variable temperature. With holder for thermopile. One side each is plain, matt, white or painted black.

Heater power:	150 W
Max. temperature:	120°C
Resolution:	1°C
Display:	Two rows for actual and set-point temperatures
Dimensions:	250x250x220 mm ³ approx.
Weight:	1.8 kg approx.

Crookes Radiometer

Device for demonstrating the conversion of radiation energy into kinetic energy. Rotary-vane wheel mounted on a metal tip and equipped with four plates, each coloured black on one side; housed in an evacuated glass bulb.

Height:	210 mm
Ball diameter:	80 mm

P-1002882



P-1002882

Advantages

- Regulated electric heater with 150 W lamp
- Easy adjustment and display of actual and set-point temperatures
- No naked flame and no hot water required
- The cube can be turned, ensuring all surfaces are equidistant from the thermopile
- No additional stands needed

Leslie Cube with Heater (230 V, 50/60Hz)

P-1017730

Leslie Cube with Heater (115 V, 50/60Hz)

P-1017729

Additionally required:

P-1000824 Moll Type Thermopile



P-1008523



UE4050200
PDF online

Stefan-Boltzmann Lamp

High temperature source designed to produce thermal radiation, for investigating how such radiation depends on the temperature and to confirm the Stefan-Boltzmann law. The tungsten filament represents a good approximation of a point source of heat radiation and is thus highly suitable for investigating the inverse square law. The temperature of the lamp can be determined from the resistance of the filament. To minimise voltage loss, the lamp contacts are soldered to the connectors.

Nominal voltage:	12 V DC
Nominal current:	1.75 A
Nominal power:	21 W
Max. operating parameters:	13 V DC/2 A
Maximum temperature of filament:	3600 K

Contents:

- 1 Stand rod, 130 mm long
- 1 Stefan-Boltzmann lamp

P-1008523

Additionally recommended:

P-1003312 DC Power Supply 20 V, 5 A (230 V, 50/60 Hz)

or

P-1003311 DC Power Supply 20 V, 5 A (115 V, 50/60 Hz)

P-1003034 Storage Rail

P-1000824 Moll Type Thermopile

P-1002785 Digital Multimeter P3340 (3x)

Experiments on Heat Conduction and Electrical Conduction

Experiments on Heat Conduction and Electrical Conduction. Determination of electrical conductivity of copper and aluminium.

Quantity / Designation	Art. No.
1 Thermal conduction rod, Cu	P-1017330
1 Thermal conduction rod, Al	P-1017331
1 Microvoltmeter (230 V, 50/60 Hz)	P-1001016
or	
1 Microvoltmeter (230 V, 50/60 Hz)	P-1001015
1 DC power supply, 0 – 20 V, 0 – 5 A (230 V, 50/60 Hz)	P-1003312
or	
1 DC power supply, 0 – 20 V, 0 – 5 A (115 V, 50/60 Hz)	P-1003311
1 Digital Multimeter	P-1002781
1 Set of experiment leads, 75cm	P-1002841

Heat Conduction Equipment Set

Equipment set for investigating the heat conducting capabilities of metals in complete safety. The equipment set consists of an electronically regulated heat source for warming up a heat conducting rod, an insulating sleeve to reduce loss of heat to the surroundings and improve the linearity of the temperature profile, plus cooling baffles which can be used to radiate heat away from the apparatus. With a voltmeter and ammeter connected, it is possible to determine the electric power supplied to achieve the heating.

Maximum heating capacity: 43 W approx.

Maximum heat loss: 4.5 W

Temperature of heat source: 105°C

Operating voltage: 12 V DC

Maximum heating current: 3.6 A

Includes:

- 1 Heating module
- 1 Insulating sleeve
- 1 Cooling baffle (heat sink)
- Heat conducting paste

P-1017329

Additionally required:

P-1017331 Heat conducting rod, aluminium

or

P-1017330 Heat conducting rod, copper

P-1017579 Table-top power supply

or

P-1003312 DC power supply, 0 – 20 V, 0 – 5 A (230 V, 50/60 Hz)

or

P-1003311 DC power supply, 0 – 20 V, 0 – 5 A (115 V, 50/60 Hz)

Investigation of heat conduction in copper and aluminium in dynamic and static states

Quantity / Designation	Art. No.
1 Heat conducting rod, Cu	P-1017330
1 Heat conducting rod, Al	P-1017331
1 Heat conduction equipment set	P-1017329
1 DC power supply, 0 – 20 V, 0 – 5 A (230 V, 50/60 Hz)	P-1003312
or	
1 DC power supply, 0 – 20 V, 0 – 5 A (115 V, 50/60 Hz)	P-1003311
2 Digital Multimeters	P-1002781
1 Digital thermometer, 2 channel	P-1002794
1 Set of experiment leads	P-1002841

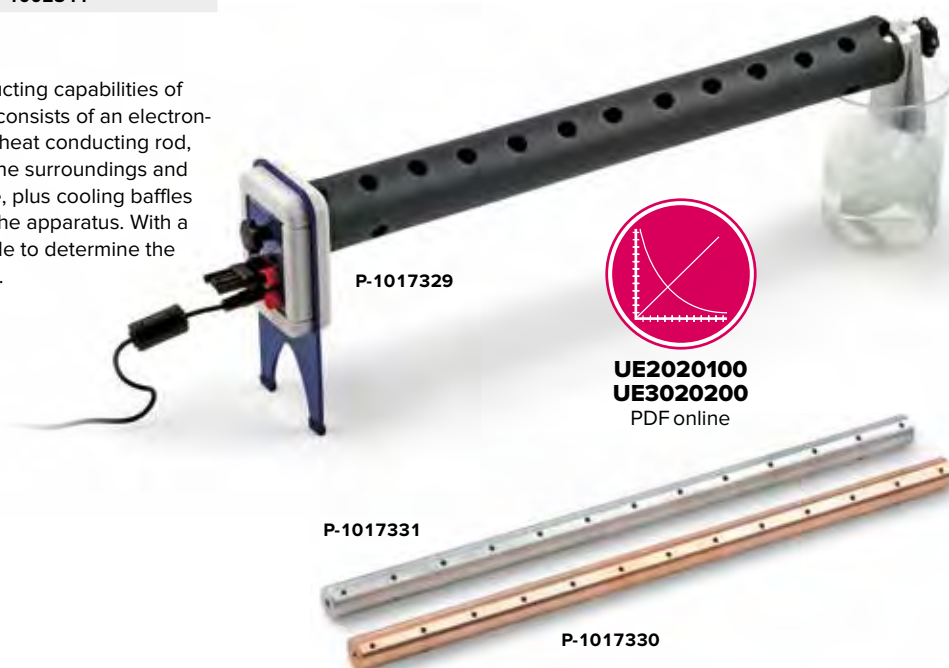

Heat Conducting Rods

Heat conducting rods for investigating heat conductivity in conjunction with the heat conduction equipment set or for investigating electrical conductivity with the help of four-wire measurement.

Length: 500 mm

Cross sectional area: 490 mm²

Measuring points: 13

Distance between

measuring points: 40 mm

Heat conductivity (Al): 236 Wm⁻¹K⁻¹

Heat conductivity (Cu): 240 – 380 Wm⁻¹K⁻¹

Heat Conducting Rod, Al

P-1017331

Heat Conducting Rod, Cu

P-1017330

Table-Top Power Supply

Table-top power supply for supply of power to the heat conduction equipment set.

Mains voltage: 100 – 240 V AC/1 A, 50/60 Hz

Output voltage: 12 V DC/4 A

P-1017579



P-1017579

Experiment Topics:

- Thermal motion of atoms and molecules in various states of aggregation
- Electrical conduction processes
- Models of atomic physics
- Mechanical motion

Air-Cushion Plate

An ideal device for demonstrating a series of experimental models intended to study the motion of atomic particles:

- Objects hovering on the air cushion experience near-zero friction and are used to simulate particle motion. The set contains five different transparent, coloured plastic or aluminium elements with round ceramic magnets fitted to them to ensure elastic collisions.
- Magnetic barriers can be used to modify the plastic-bordered experimentation surface. This allows elastic collisions between the hovering bodies and the borders.
- A lattice model with a fixture is available for emulating crystal lattices in experiments on electrical conductivity in semiconductors, for instance. Comprises a height-adjustable acrylic plate from which 25 ceramic magnets are freely suspended.
- Two rod-shaped metal electrodes can be positioned in parallel with the experimentation surface in order to generate an electrical field. The effect of electrical fields on charged particles can also be simulated by inclining the experimentation surface.

The equipment system is characterised by a clear and simple design, minimum preparatory adjustment requirements, clear visibility of all experiments through overhead projection, simple operation and high reliability. The device consists of a robust frame with a pressure chamber whose cover plate is furnished with 1089 fine perforations and serves as an experimentation surface. Air is supplied to the pressure chamber by a blower via a hose, causing the coloured bodies to hover. An additional air stream from an impulse valve makes it possible to alter the motion of the hovering bodies. The air-cushion table is equipped with two adjustment screws. With two adjustable screws for horizontal alignment.

Dimensions: 350x350x75 mm³

Contents:

Air-cushion plate

Magnetic hovering bodies:

- Red, 16 mm diam. (30x)
- Green, 16 mm diam. (25x)
- Aluminium, 21 mm diam. (5x)
- Orange, 28 mm diam. (25x)
- Blue, 48 mm diam. (1x)

Magnetic barriers:

- 253 mm (2x)
- 233 mm (1x)
- 233 mm with a recess (1x)
- 233 mm with an opening, flat, with 4 magnets (1x)

Magnetic piston

Lattice model

Fixture for lattice model

Pair of electrodes

Plexiglass plate

Manipulation rod

Tweezers

Experiment manual

Wooden storage box

Tube

P-1002981.....

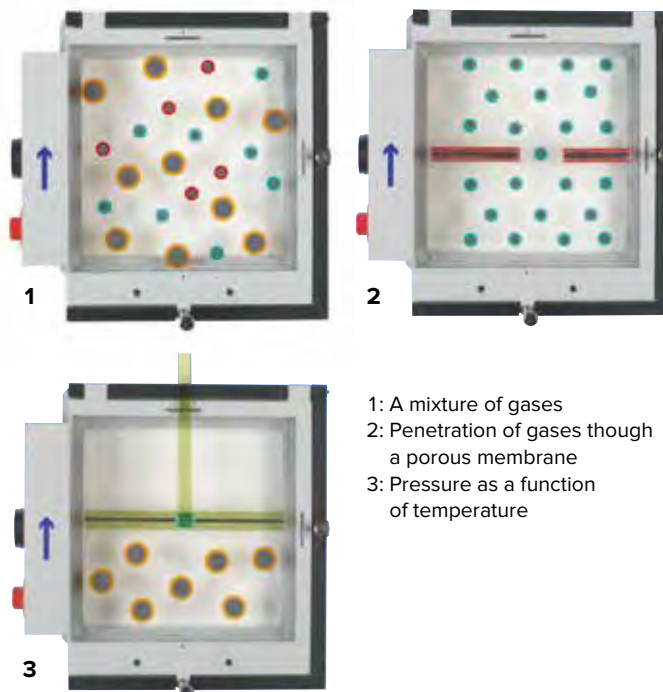

- 1: A mixture of gases
- 2: Penetration of gases through a porous membrane
- 3: Pressure as a function of temperature

Additionally required:

P-1000606 Air Flow Generator (230 V, 50/60 Hz)

or

P-1000605 Air Flow Generator (115 V, 50/60 Hz)

**Kinetic gas theory
made visible**



P-1002981

Qualitative Observations

- Liquid and gaseous states
- Dynamic compression and expansion
- Critical opalescence
- Formation of the transition point at various temperatures

Quantitative Measurements

- Display of the critical point and temperature
- Recording of isotherms in p-V (Clapeyron) diagrams
- Recording of isotherms in pV-p (Amegat) diagrams
- Pressure curves for a saturated vapour
- Differences between real gases and ideal gases



P-1002670

Mercury-free

Critical Point Apparatus

A high-precision apparatus for studying the compression and liquefaction of a gas, determining the critical point and recording isotherms in p-V (Clapeyron) diagrams. The test gas is sulphur hexafluoride (SF_6), which has a critical temperature of 318.6 K (45.5°C) and a critical pressure of 3.76 MPa (37.6 bars), allowing for a simple experiment set-up. The apparatus includes a transparent measuring cell that is highly resistant to leakage and compression. The volume inside the cell is changed via a finely adjustable handwheel, the change being indicated by a combination of a fixed and a rotary scale to an accuracy of $\frac{1}{1000}$ of the maximum volume. The pressure is generated by a hydraulic system containing castor oil of medically approved quality. The measuring cell and hydraulic system are separated by a cap seal which rolls in as the volume increases. This design means the pressure gradient between the measuring cell and oil chamber is negligible. A manometer measures gas pressure instead of oil pressure without taking up any dead space inside the measuring cell. During transitions from the gaseous to the liquid phases and vice versa, it is therefore possible to observe the formation of the first drops of liquid and disappearance of the last gas bubbles. The measuring cell is enclosed in a transparent water chamber. A circulation thermostat allows the temperature to be maintained at a highly constant value, which can be monitored by means of a thermometer. Practical indications of the volume, pressure and temperature permit easy recording of p-V or pV-p diagrams providing qualitatively correct results. Pres-

sure and temperature-dependent volumetric corrections also provide quantitatively accurate results comparing favourably with standard reference values.

Critical temperature:	318.6 K (45.5°C)
Critical pressure:	3.76 MPa (37.6 bars)
Critical volume:	197.4 cm^3/mol
Critical density:	0.74 g/mol
Temperature range:	10 – 60°C
Maximum pressure:	6.0 MPa (60 bars)
Maximum volume:	15.7 cm^3
Manometer diameter:	160 mm
Bore for temperature sensor:	6 mm diam.
Temperature control connections:	7 mm diam.
Reducing valve connection:	$\frac{1}{8}$ " diam.
Standard gas connection:	3.5 mm diam.
Dimensions:	380x200x400 mm^3
Weight:	7 kg approx.

Contents:

- 1 Critical point apparatus filled with hydraulic (castor) oil but without test gas (SF_6). Includes built-in safeguarded connection nozzle for MINICAN® gas canisters
- 1 Oil filling device
- 1 Angled 1.3-mm hexagonal spanner (for grub screw on rotary scale)
- 1 Plastic hose, 3 mm internal diameter
- 1 $\frac{1}{8}$ " pipe screw connection (SW 11)
- 1 Grease gun

P-1002670

Additionally required:

P-1008654 Immersion/Circulation Thermostat (230 V, 50/60 Hz)

or

P-1008653 Immersion/Circulation Thermostat (115 V, 50/60 Hz)

P-1002622 Silicone tubing, 1 m (2x)

P-1002803 Digital quick-response pocket thermometer

P-1002804 Immersion Sensor, NiCr-Ni, type K, -65°C – 550°C

Sulphur hexafluoride SF_6

Additionally required in case of degassing hydraulic oil:

P-1002671 Castor Oil

High-Power Vacuum Pump

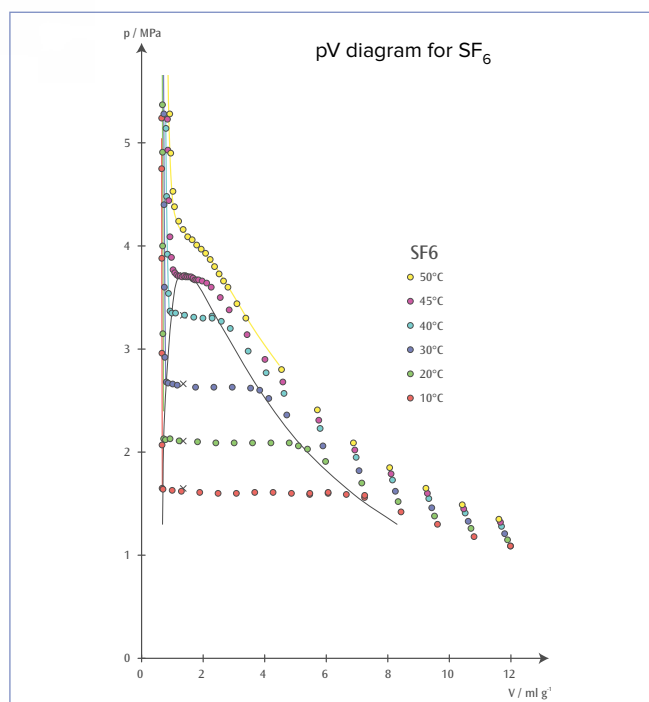

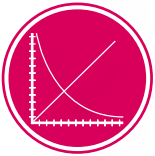

UE2040300
PDF online

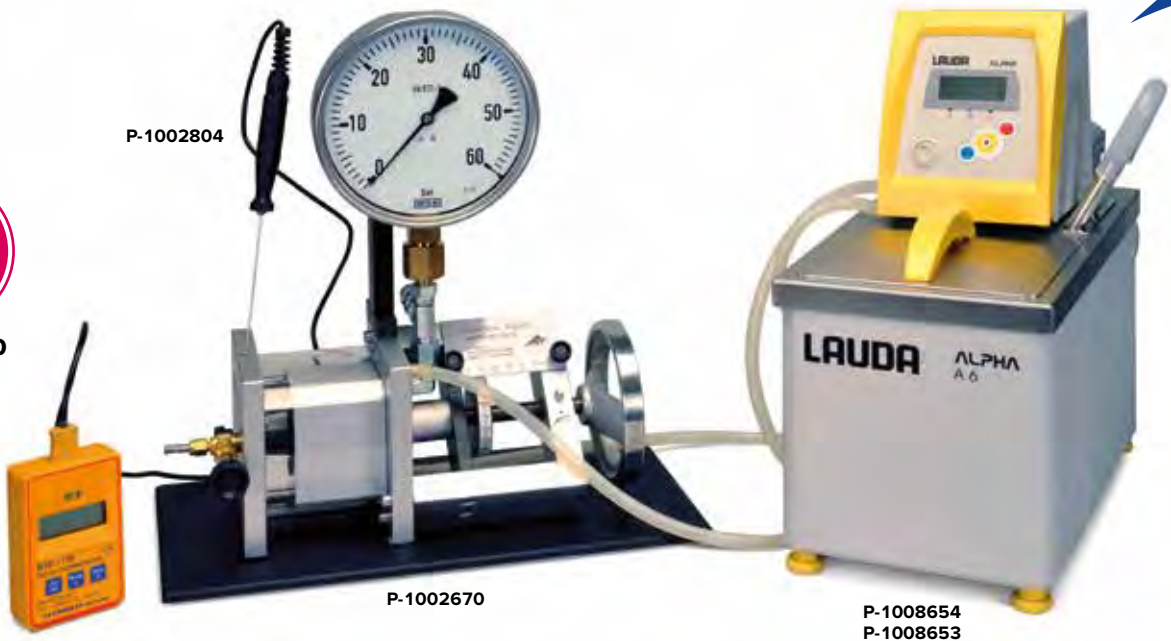

Note:

In accordance with good laboratory practice, it is advisable to obtain gas via a fixed pipeline if the critical-point apparatus is used frequently. In case of occasional usage, it is more expedient to obtain the test gas from MINICAN® canisters. A MINICAN® gas connection is designed similarly to the valve on a common spray can, i.e. it is opened simply by fitting the MINICAN® on the gas connection nozzle.

Set of Seals (not shown)

Set of spare seals for critical point apparatus (P-1002670). Includes a rubber cap seal, round rubber seal of diameter 60 mm, square rubber seal 78x78 mm², a sealing ring of diameter 30/20 mm, four copper sealing discs and a threaded bush made of POM (Polyoxymethylene).

P-1002672

Castor Oil (not shown)

250 ml of DAB approved castor oil for filling critical point apparatus (P-1002670).

P-1002671

Accessories for Kinetic Gas Theory

Accessories for vibration generator (P-1000701) for simulating particle motion in an ideal gas. Differently coloured spheres (gas model) are set in motion by mechanical vibrations.

Contents:

- 1 Plexiglas cylinder, length 300 mm
- 1 Circular disc
- 1 Set of spheres of different colours

P-1000704

Additionally required:

- P-1000701** Vibration Generator
- P-1009957** Function Generator FG 100 (230 V, 50/60 Hz)
- or
- P-1009956** Function Generator FG 100 (115 V, 50/60 Hz)

Immersion/Circulation Thermostat

Immersion/circulation thermostat for setting the temperature of a bath or external apparatus with non-flammable liquids at temperatures up to 95°C. The fully electronic continuous regulator and the powerful circulating pump ensure that the water in the bath is optimally stirred so that the temperature remains highly constant. The user-friendly menu and simple three-button operation guarantee that the equipment is easy to use. A single-row LED display indicates the desired temperature and the actual temperature. Excess temperature protection is set to a fixed value of 95°C and features both audible and visual alarms to enhance operating safety. Also included is the possibility of connecting a water cooler or heat exchanger to provide cooling by means of tap water.

- Operating-temperature range: 25°C – 100°C
- Temperature constancy: ±0.05°C
- Heating power: 1.5 kW
- Pump pressure: max. 0.2 bar
- Delivery rate: max. 15 l/min
- Bath volume: max. 5.5 l
- Bath area / depth: approx. 145x161x150 mm³

Immersion/Circulation Thermostat (230 V, 50/60 Hz)

P-1008654

Immersion/Circulation Thermostat (115 V, 50/60 Hz)

P-1008653

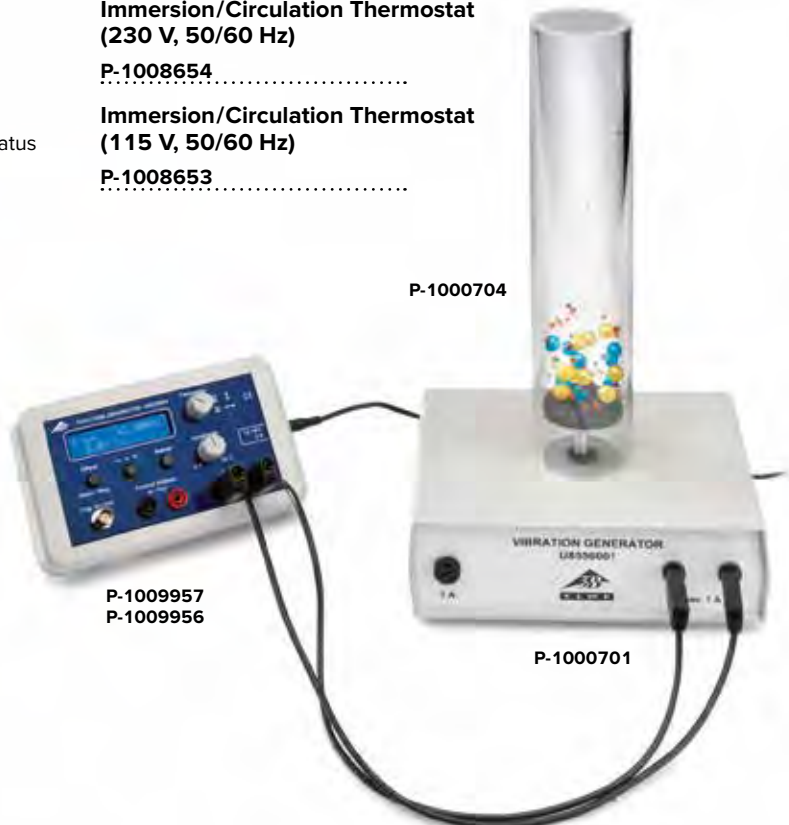

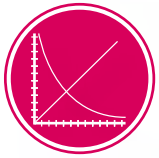
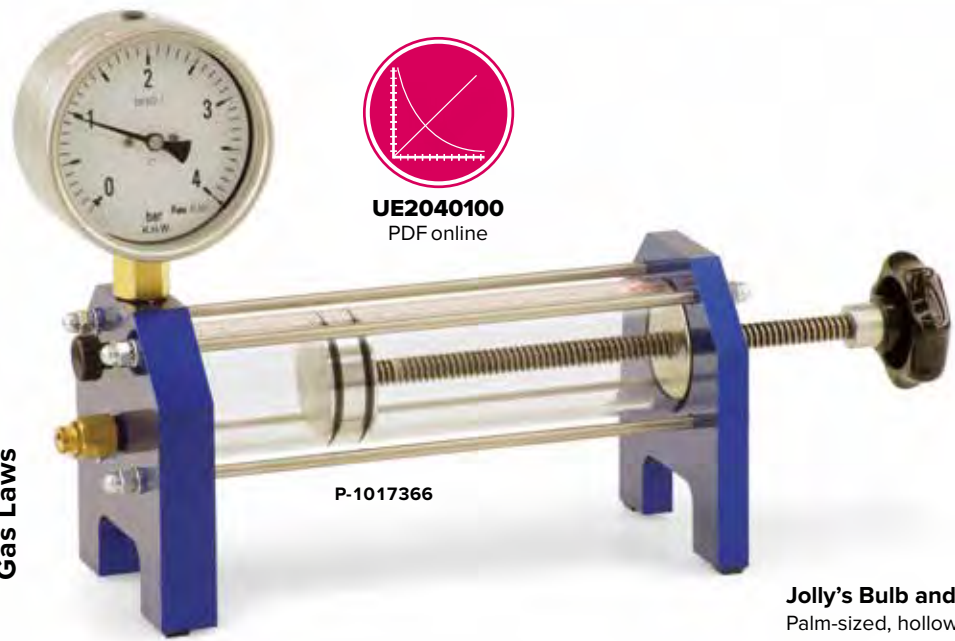

UE2040100
PDF online

P-1017366

Boyle's Law Apparatus

Apparatus for determining experimentally the relationship between gas volume and pressure at constant temperature (Boyle's law). The working cylinder is made of transparent acrylic and has a moving piston, scale and manometer. Along with a valve to let in gas or release it. The movement of the piston is achieved with the help of a threaded connecting rod turned by means of a turning knob. In this way, pressure both above and below atmospheric can be generated. For safety reasons, the working cylinder is enclosed in another protective transparent acrylic cylinder.

- Length: 300 mm
- Internal diameter: 40 mm
- Piston: 30 mm x 40 mm diameter
- Piston sealing: 2 ring gaskets
- Manometer diameter: 100 mm
- Permitted pressure: max. 4 bar

P-1017366

Pneumatic Lighter

Device for demonstrating the ignition of diesel. By swiftly pressing down the piston, the compressed air in the transparent tube is heated so strongly that a piece of paper placed at the bottom of the tube very clearly ignites. Similarly, a cotton-wool pad soaked in ether also catches fire.

- Length of compression tube: approx. 150 mm

P-1003569

Spare Tube for Pneumatic Lighter (not shown)

Spare tube for pneumatic lighter (P-1003569).

P-1003570



P-1003569

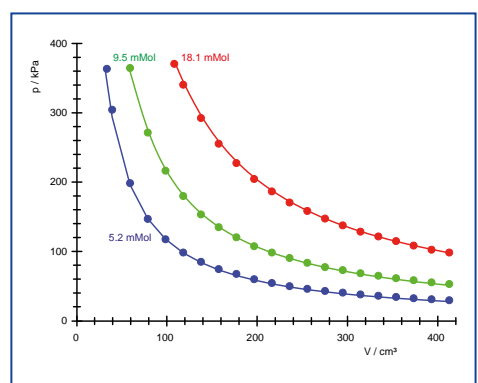

Pressure-volume diagram

P-1012870

Jolly's Bulb and Gauge

Palm-sized, hollow metallic ball with a manometer connected to it for demonstrating change of pressure in a closed volume of air when heated or cooled. Immersing the ball in a water bath at a specific temperature allows the relationship between pressure and temperature of the enclosed air to be investigated in order to demonstrate the behaviour of an ideal gas.

- Hollow ball: 60 mm diam.
- Manometer: 840 – 1240 hPa

P-1012870

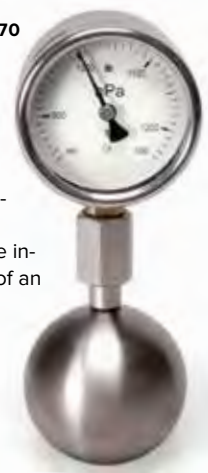

Oscillation Tube

For determining adiabatic exponent c_p/c_v of air by Rüchardt's method, used in conjunction with Mariotte flask (P-1002894). Precision glass tube with precisely fitting aluminium cylinder. If the glass tube is placed vertically on a glass flask of 10 l volume and the aluminium cylinder is allowed to slide into the glass tube, it can be made to undergo harmonic oscillations on the air cushion resulting from the enclosed volume of air. c_p/c_v can then be calculated from the period.

- Dimensions: 600 mm x 16 mm diam. internal
- Aluminium cylinder: 15.2 g

P-1002895

- Additionally required:
- P-1002894 Mariotte Flask**
- P-1002811 Digital Stopwatch**

- Additionally recommended:
- P-1012856 Vacuum Hand Pump**

P-1002895

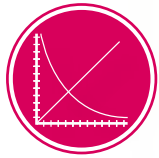

UE2040200
PDF online

P-1002894

Mariotte Flask

Duran glass flask with discharge opening at base and two rubber stoppers with boreholes. Volume: 10 l

P-1002894

- Additionally recommended:
- P-1002895 Oscillation Tube**



Experiment Topics:

- Recording and evaluating a pV diagram
- Operation of a Stirling engine as a heat pump or refrigerator
- Operation of a Stirling engine as a classical heat-engine

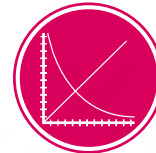

UE2060250
PDF online

Advantages

- Durability and high precision thanks to the use of high-quality materials
- Easily understood, transparent design allows the functioning to be viewed with ease
- Featuring built-in generator unit

Stirling-Engine G

Transparent Stirling engine for quantitative investigations of the Stirling cycle, as a heat engine, heat pump and refrigerating machine. The displacement cylinder and displacement piston are made of heat resistant glass; the power cylinder, flywheel and gearbox cover are made of acrylic glass. This allows very clear observation of the individual sequences of motion at all times. The crankshafts have ball bearings and are made of hardened steel. The connecting rods are made of wear resistant plastic. Includes spirit burner with adjustable wick for use as a heat source. The glass of the displacement cylinder is also equipped with recessed temperature measurement sockets before and behind the displacement piston, to allow measurements of temperature differences during operation as a heat pump or refrigerating machine. The large flywheel made of acrylic glass has imprinted markings to allow measurement of revolutions per unit of time using a light barrier. For recording pV-diagrams, it is possible to measure the pressure in the power cylinder via a hose connection; the string included in the scope of delivery can be fastened to the power piston to measure the stroke in order to determine the volume. The integrated engine generator unit with a two stage belt pulley allows a conversion of the produced mechanical energy into electrical energy. Equipped with a switchover option for operating an integrated lamp or external loads, or feeding electrical energy for operation as a heat pump or refrigerating machine, in accordance with the direction of rotation of the Stirling engine.

Power of the Stirling engine:	1.5 W
Idling speed:	1000 rpm
Flywheel:	140 mm diam.
Power cylinder:	25 mm diam.
Stroke of the power piston:	24 mm
Gas volume:	32 cm ³ – 44 cm ³
Motor generator unit:	max. 12 V DC
Belt pulley:	two stage (30 mm diam., 19 mm diam.)
Dimensions:	300x220x160 mm ³
Weight:	1.6 kg

P-1002594

Additionally recommended:

- P-1000548** Relative Pressure Sensor ± 1000 hPa
- P-1000568** Displacement Sensor
- P-1008500** Sensor Holder for Stirling Engine G
- P-1000544** 3B NETlab™
- P-1000540** 3B NETlog™ (230 V, 50/60 Hz)
- or
- P-1000539** 3B NETlog™ (115 V, 50/60 Hz)

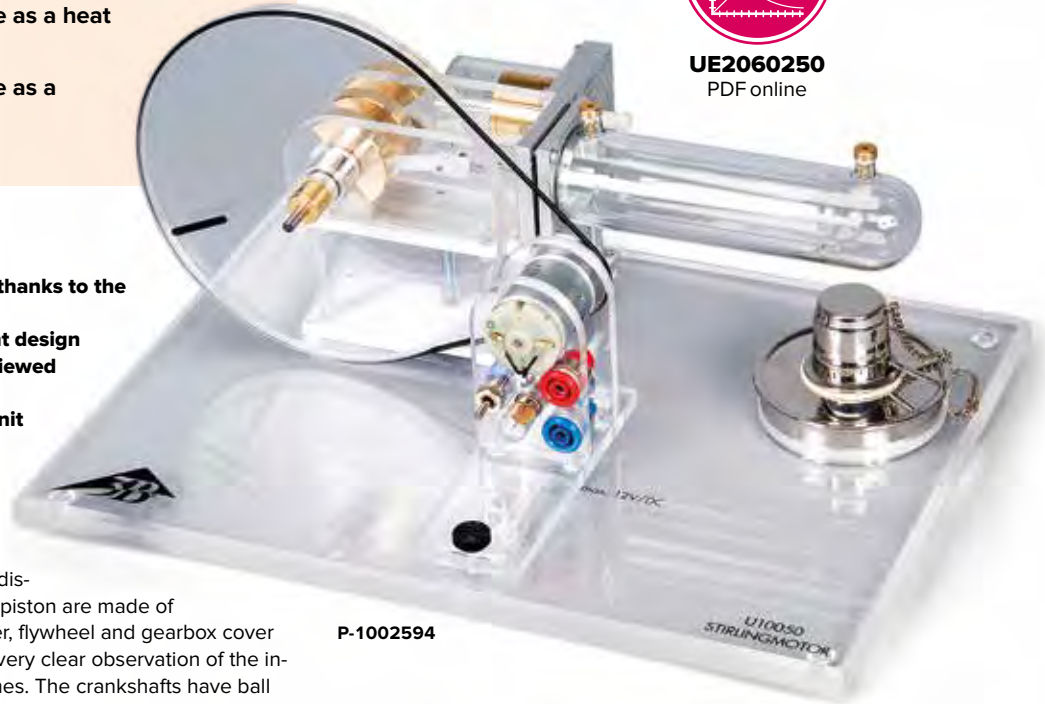

P-1002594

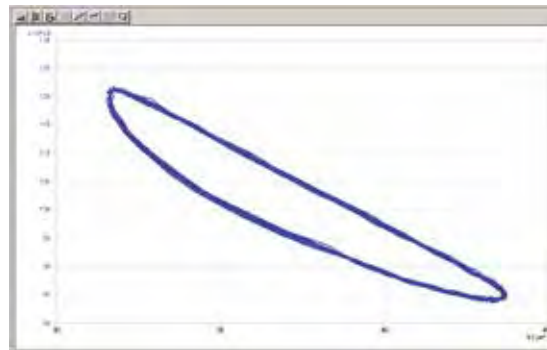

Pressure-volume diagram of Stirling engine G

Sensor Holder for Stirling Engine G

Holder for a relative pressure sensor (P-1000548) and a displacement sensor (P-1000568) for use with the G-series Stirling engine (P-1002594).

P-1008500

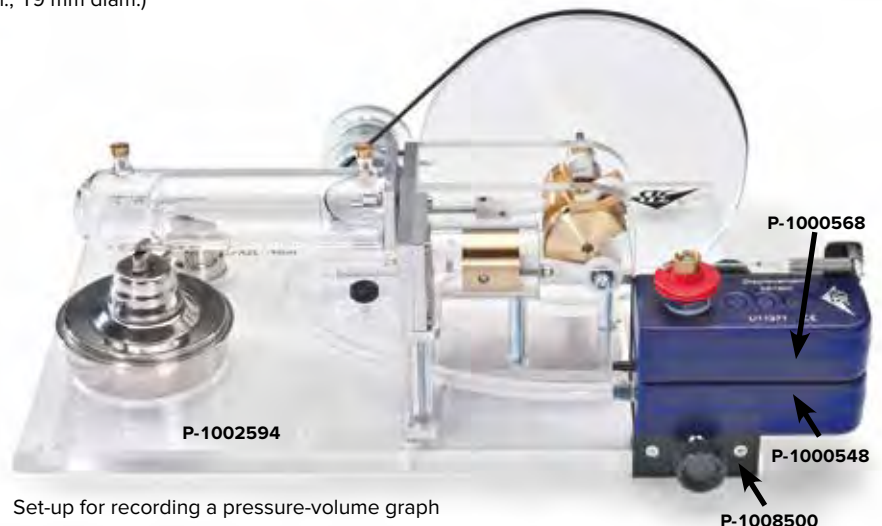

Set-up for recording a pressure-volume graph

Experiment Topics:

- Operation of a Stirling engine as a classical heat-engine
- Measurement of the no-load (idling) rate of rotation as a function of the heat input
- Recording and evaluating a pV diagram

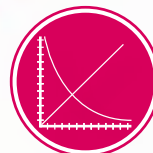

UE2060100
PDF online

P-1000817

Advantages

- Slow running allows for the interaction between the displacement piston and working piston to be observed easily
- Discontinuous motion of the piston provides for almost perfect p-V (pressure-volume) diagrams
- It is possible for the system to be heated by absorption of radiant heat

Stirling Engine D

A functional model of a Stirling engine based on an idea by Professor Wilcke optimised for demonstrating to students the conversion of thermal energy into mechanical energy and the operation of a thermal engine, as well as investigating the Stirling cycle. The interplay between the displacement piston and the power piston can be seen especially clearly at a low rate of rotation. In this version the displacement piston moves discontinuously, with a dwell time during the heating of the working medium (air) and a second dwell time during its cooling. This offers a clearer demonstration of the ideal Stirling cycle than is possible with continuous piston movement. The heat source can be provided by an integrated electric hotplate, a candle flame, or focused adiation from the sun or from a lamp. In the latter case the direction of rotation will depend on whether the heat is applied from above or from below. For recording pV diagrams, the pressure can be measured via a rubber hose connection on the power cylinder, and the volume can be measured by attaching a thread to the power piston to follow its movement.

Heater voltage: 8 – 12 V, 1.5 A
 Gas volume: 330 cm³ – 345 cm³
 Flywheel rod: 400 mm
 Dimensions without flywheel rod: 260x185x330 mm³
 Weight: 2.2 kg

P-1000817

Additionally recommended:

P-1000547 Relative Pressure Sensor ± 100 hPa

P-1000568 Displacement Sensor

P-1008516 Supplementary Set for Stirling Engine D

P-1000544 3B NETlab™

P-1000540 3B NETlog™ (230 V, 50/60 Hz)

or

P-1000539 3B NETlog™ (115 V, 50/60 Hz)



With discontinuous piston motion

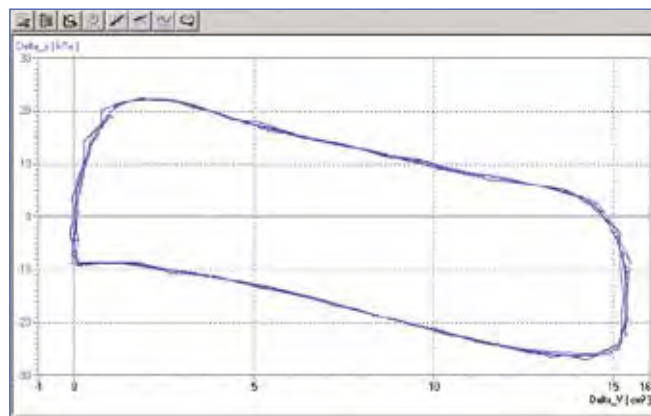

Pressure-volume diagram of Stirling engine D

Supplementary Set for Stirling Engine D

Set of equipment for adding a displacement sensor (P-1000568) and a relative pressure sensor (P-1000547) to the D-series Stirling engine (P-1000817). The set consists of the following components:

- 1 Base plate to accommodate the pressure sensor
- 1 Knurled screw for fastening the base plate to a stand rod
- 1 Stem with magnetic base for displacement sensor
- 1 Silicone tubing for connecting ± 100 -hPa relative pressure sensor
- 1 Set of threads with suction pad
- 2 Weights with hook, 20 g each

P-1008516

P-1008516



P-1002598



Cyclic Processes

Advantages

- Runs with a temperature difference of just 5°C between the top and bottom plates
- Heat can be fed from below (e.g. heat from a human hand) or above (e.g. heat from the sun)
- Transparent components make it easy to view the functioning
- Also available in kit form

Low Temperature Stirling Engine

A compact, transparent Stirling engine for demonstrating the operation and fundamental design of such engines. A temperature difference of approximately 5° C between the base and top plates is sufficient to set the motor in motion. This difference can be generated just by the warmth of a human hand or by cooling through contact with a cold object from a refrigerator. The top plate's matt, black coat also enables the device to be operated as a solar-powered engine. In this case the direction of rotation will depend on whether the heat is applied from above or from below. The power cylinder is made of precision glass, while the displacement cylinder and flywheel are made of acrylic glass; this allows a clear observation of the movements of the power piston, displacement mechanism and crankshaft drive. The crankshaft and connecting rod have miniature precision ball bearings.

Rotation speed: 80 rpm at $\Delta T = 10^{\circ}\text{C}$
 Flywheel: 110 mm diam.
 Dimensions: 138 mm x 110 mm diam.

P-1002598



P-1002599

Low Temperature Stirling Engine, Assembly Kit

P-1002599

Stirling Engine S

This affordable Stirling engine comes complete with built-in alcohol burner. Red flywheels and chassis mounted on a green base, this all-metal engine runs silently at speeds in excess of 1,000 rpm. The engine demonstrates the principle of the Stirling cycle and the functioning of a classical heat engine. It comes completely assembled and ready to run, accompanied by the book "Stirling Cycle Engines" which explains the principles of operation.

Rotation speed: 1000 rpm
 Base plate: 180x110 mm²
 Weight: 1.15 kg

P-1003505

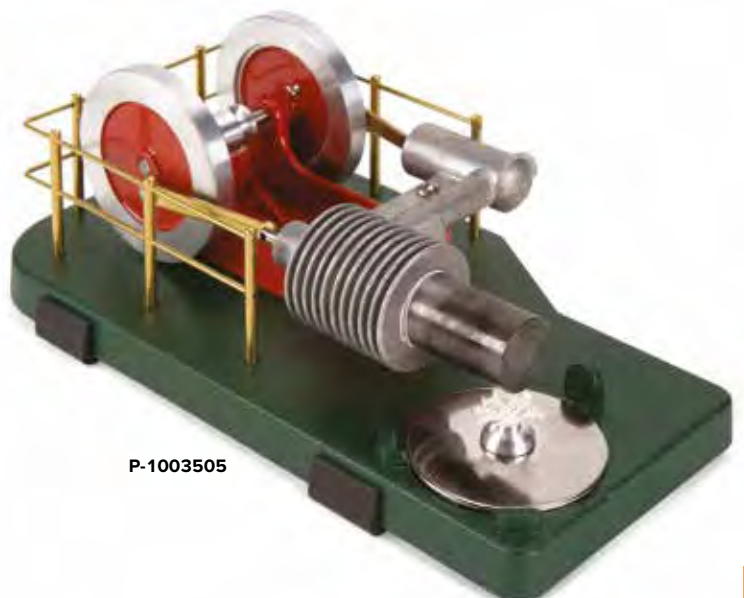

P-1003505

Heat and Thermodynamics

Advantages

- Very clear demonstration model with a compact and easily understood design
- The layout of the components matches the sequence of a heat cycle
- Inspection windows for observing how the refrigerant changes state

Heat Pump D

Demonstration model for showing how refrigerators and electrical compression heat pumps work. Consisting of compressor with drive motor, vaporiser, expansion valve and condenser. May be used as an air water or water water heat pump. Includes wattmeter, so that one can record the operation time, the mains voltage, instantaneous power input and electrical work, and two thermometers for measuring the temperatures in the two reservoirs. The components are connected in a closed system by copper pipes and mounted on a base board, and the clear layout makes it possible to directly relate the sequence of changes of state to the cyclic operation of the heat pump. Evaporator and condenser are constructed as copper tubing spirals and each of them is submerged in water filled containers serving as heat reservoirs for determining the heat absorbed or emitted. Two large manometers display the pressure ratios of the coolant in both heat exchangers. Two observation windows are provided for observing the state of aggregation of the refrigerant after the evaporator and after the condenser. A protective overpressure switch disconnects the compressor motor from the circuit when overpressure reaches 15 bars. Compressor power: 120 W

Coolant: R 134A, free of chloro-fluorohydrocarbons

Temperature reservoirs: 2000 ml each

Manometer: 160 mm diam.

Dimensions: 560x300x630 mm³

Weight: 21 kg

Heat Pump D (230 V, 50 Hz)

P-1000820

Heat Pump D (115 V, 60 Hz)

P-1000819

Experiment Topics:

- Determining the power output as a function of the temperature difference
- Analysing the cyclic process by means of a Mollier diagram

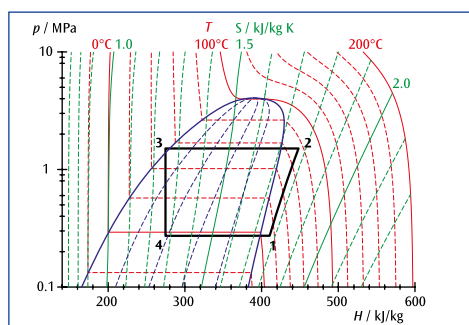

Pressure-enthalpy diagram of heat pump



UE2060300
PDF online

P-1000820
P-1000819



P-1009922

Temperature Sensor, Pt100 with Measurement Terminal

Temperature sensor for the measurement of temperatures on the copper tubing of a heat pump (P-1000820 or P-1000819). Temperature sensor shaft made of rust-proof stainless steel. Tip with matching copper terminal. Can be used in conjunction with 3B NET/log™ unit (P-1000540 or P-1000539) for manual measurements or for processing measurement data when connected to a computer. Includes connector lead with 8 pin miniDIN plugs.

Measurement range: -50°C – 150°C

Resolution: 0.1°C

Accuracy: 0.1% of measured value plus 0.25°C

Sensor cable: 1 m, with silicone insulation

Sensor type: Pt100 thermocouple

P-1009922



P-1002597

Advantages

- Easily understood, transparent design allows the sequence of movements to be viewed simply
- Durability and high precision thanks to use of high-quality materials

Steam Engine G

Transparent steam engine for demonstrating how an oscillating steam engine operates. In this engine the cylinder moves around a centre axis. This motion causes the inlet port and outlet port of the steam conduit to open and close. The base plate and flywheel are made of acrylic glass, while the boiler and working cylinder are made of heat proof quartz glass, making all of the moveable parts and actions very clearly visible. With a ball bearing supported crankshaft made of brass and a safety valve built into the boiler to prevent excessive pressure. Includes spirit burner with adjustable wick for use as heat source.

Rotation speed:	800 rpm
Mech. Power:	1 W
Boiler volume:	50 ml
Run time per load:	20 – 25 min
Max. operating pressure:	0.5 bars
Dimensions:	260x170x110 mm ³

P-1002597

Steam Engine B

Steam engine model for demonstrating a cycle where the working substance (water and steam) changes phase. Includes a fixed brass cylinder which operates in both directions with a flywheel and drive wheel also operating in both directions, plus a centrifugal governor and a steam-jet oiling mechanism. Highly polished, nickel-coated brass boiler with an inspection window to show the water level, a spring safety valve and a domed steam whistle. The brass boiler is fitted onto old-copper-coloured boiler housing with a brick pattern and a chimney. The water is heated using dry fuel. A tray for collecting condensed water is located under the chimney, allowing it to “smoke” like a real steam train.

Base:	260x200 mm
Height:	240 mm
Flywheel:	70 mm diam.
Boiler:	115x45 mm diam.
Boiler volume:	155 ml
Capacity:	120 ml approx.
Weight:	1.3 kg

P-1012801

Dry Fuel for Steam Engine B (not shown)

20 Esbit fuel tablets for heating water in steam engine B (P-1012801).

P-1012886

Oil for Steam Engine (not shown)

Oil for lubricating pistons, cylinders and all other bearings of the B-model steam engine (P-1012801).

P-1012887

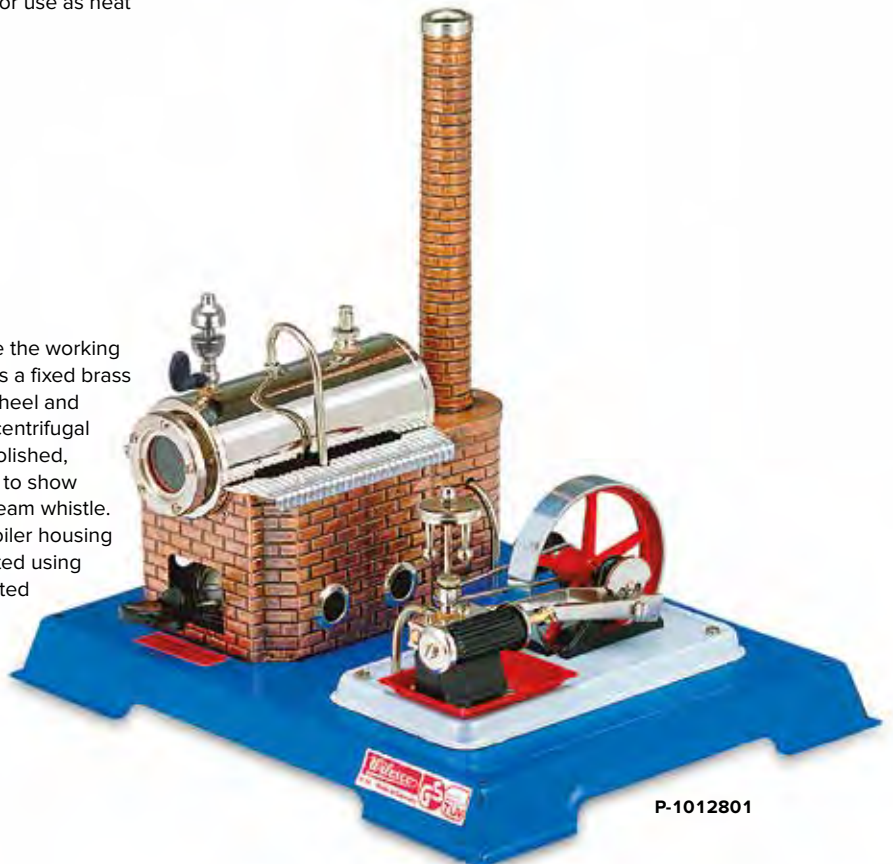

P-1012801

Experiment topics:

- Laws of reflection
- Laws of refraction
- Total reflection
- Minimum deflection angle for a prism
- Focal determination of mirrors and lenses
- Laws of lenses and image errors
- Shadow casting

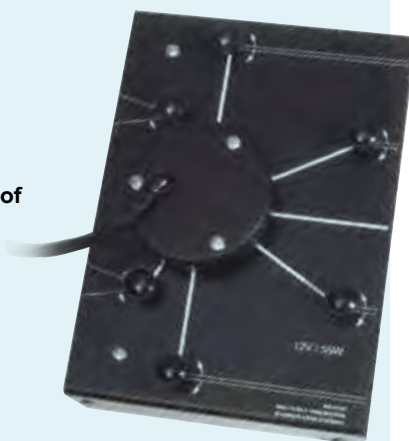

P-1003321

Multiple-Ray Projector, Magnetic

Light source for experiments demonstrating ray optics on a whiteboard (P-1002591 or P-1002592). In metal housing on magnetic foil. Experiments on reflection, refraction and basic lens laws can be performed using five narrow light rays which emerge from the right-hand side. With the help of rotating mirrors, these rays can be directed to make parallel, divergent or convergent beams, or can be masked out individually. Highly demonstrative experiments on shadow casting can be conducted using the two divergent light rays emerging from the left-hand side. With the help of rotating mirrors, these rays can be directed or masked out individually.

Lamp: 12 V, 55 W
 Connecting line: 1.5 m long with 4 mm plug
 Dimensions: approx. 150x200x50 mm³
 Weight: approx. 0.9 kg

P-1003321

Additionally required:

P-1000593 Transformer 12 V, 60 VA (230 V, 50/60 Hz)
 or

P-1006780 Transformer 12 V, 60 VA (115 V, 50/60 Hz)

Advantages

- Ideally suited for demonstration experiments
- Experiments can be carried out without darkening the room
- Experiment set-ups and hand-written notes supplement one another to give an overall picture

Optics Kit for Whiteboard

Set of optical components for use in conjunction with a single-beam lamp (P-1000682) or multiple-beam lamp (P-1003321) on a whiteboard (P-1002591 or P-1002592). All components are lined with magnetic foil or furnished with a magnet holder and can be easily mounted and aligned on the whiteboard. This apparatus permits a wide range of experiments demonstrating ray optics without the need for a dark room; handwritten notes can be added to provide a clearer explanation.

P-1000604

Additionally required:

P-1002591 Whiteboard 600x900 mm²

or

P-1002592 Whiteboard 900x1200 mm²

P-1000682 Single-Ray Projector

P-1003323 Magnetic Holder for Single-Ray Projector

or

P-1003321 Multiple-Ray Projector



P-1000604

Contents:

Art. No.	Designation	Dimensions	Material
Mirrors:			
P-1002984	Plane mirror	200x35x35 mm ³	Plastic
P-1002985	Convex – concave mirror, $f = \pm 100$ mm	200x35x35 mm ³	Plastic
Transparent objects:			
P-1002986	Plano-concave lens, $f = -400$ mm	200x40x35 mm ³	Acrylic glass
P-1002987	Plano-convex lens, $f = +400$ mm	200x40x35 mm ³	Acrylic glass
P-1002988	Plane-parallel plate	200x100x35 mm ³	Acrylic glass
P-1002989	Semi-circular body, $f = +200$ mm	diam. 200x35 mm ²	Acrylic glass
P-1002990	Right-angled prism	200x200x35 mm ³	Acrylic glass
Shadow-casting bodies:			
	Cuboid	100x20x35 mm ³	Plastic
P-1002992	Cylinder	diam. 5x35 mm ²	Plastic
	Cylinder	diam. 60x35 mm ²	Plastic

Whiteboards

Metal board with enamelled surface for demonstration experiments using magnetic components, e.g., for mechanics or optics. Scratch and acid resistant steel board that can be written on using water soluble pens. Wall mounted.

Art. No.	Designation	Dimensions
P-1002591	Whiteboard	600x900 mm ²
P-1002592	Whiteboard	900x1200 mm ²



Single-Ray Projector

Light source for experiments demonstrating ray optics on a whiteboard (P-1002591 or P-1002592). With an adjustable aperture for producing a concentrated or divergent light beam.

Lamp: 12 V, 35 W
 Connecting line: 1.5 m long with 4 mm plug
 Dimensions: approx. 120 mm x 70 mm diam.
 Weight: approx. 0.25 kg

P-1000682

Additionally required:

P-1003323 Magnetic Holder for Single-Ray Projector

P-1000593 Transformer 12 V, 60 VA (230 V, 50/60 Hz)

or

P-1006780 Transformer 12 V, 60 VA (115 V, 50/60 Hz)

Halogen Lamp, 12 V, 35 W (not shown)

Spare lamp for single-ray projector (P-1000682).

P-1003324

Magnetic Holder for Single-Ray Projector

Magnet holder for mounting single-beam lamp (P-1000682) on a white board (P-1002591 or P-1002592).

P-1003323

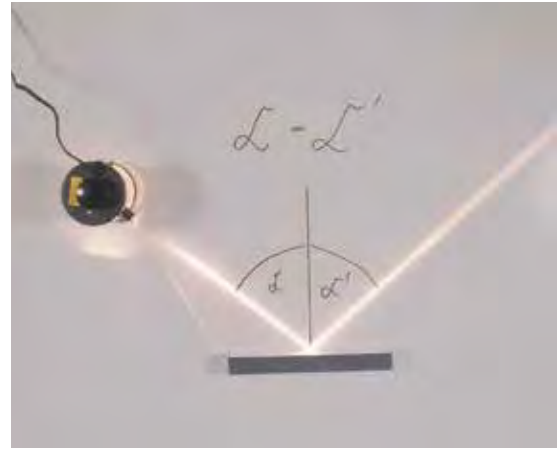

Reflection

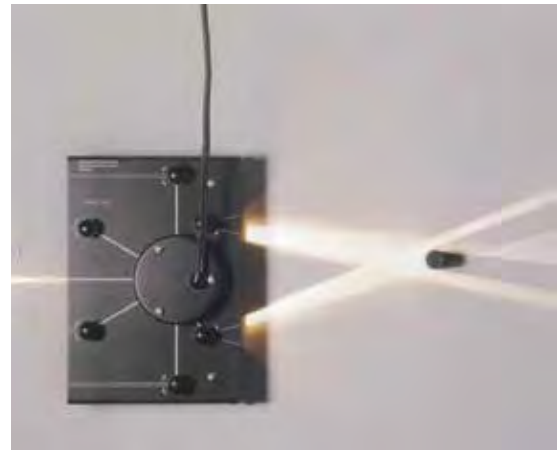

Shadow projection

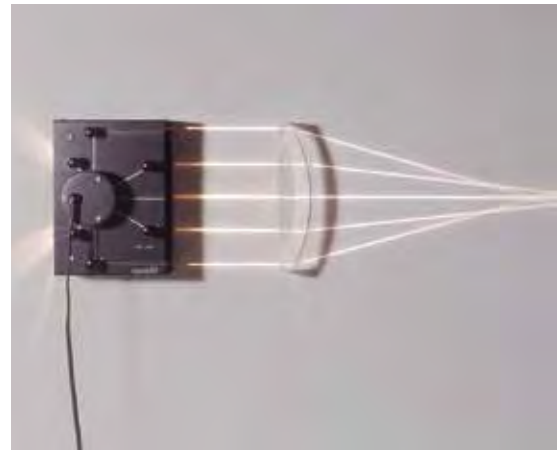

Lens errors

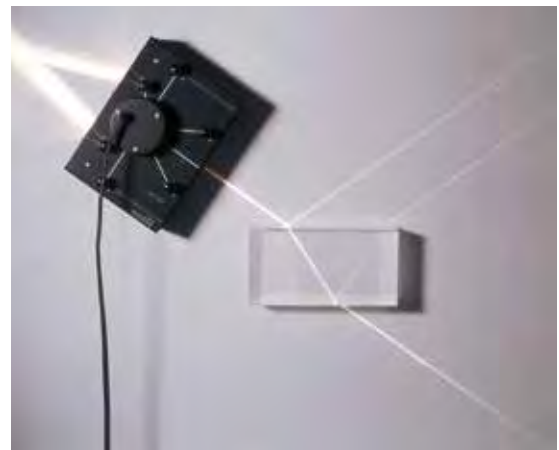

Refraction

Laser Ray Box

Laser diode capable of producing up to five parallel rays, for use with related board (P-1003056). In metal housing with magnetic foil. The number of emerging light beams can be selected electronically via switches. Power is supplied via a plug-in unit or batteries that are automatically disconnected after 60 minutes.

Diode laser: 5 beams, each max. 1 mW,
Laser safety class II
Wavelength: 635 nm
Separation of laser beams: 18 mm
Plug-in power supply: Primary 100 – 240 VAC,
Secondary 3 V DC, 300 mA
Battery compartment: for 2x 1.5 V AA-batteries
(batteries not included)
Dimensions: approx. 110x60x20 mm³

Laser Ray Box (230 V, 50/60Hz)

P-1003052

Laser Ray Box (115 V, 50/60 Hz)

P-1003051

Board for Laser Ray Box

Magnetic board for conducting experiments with laser ray box (P-1003052 or P-1003051). With a removable prop for inclining board.

Dimensions: app. 600x450 mm²

P-1003056

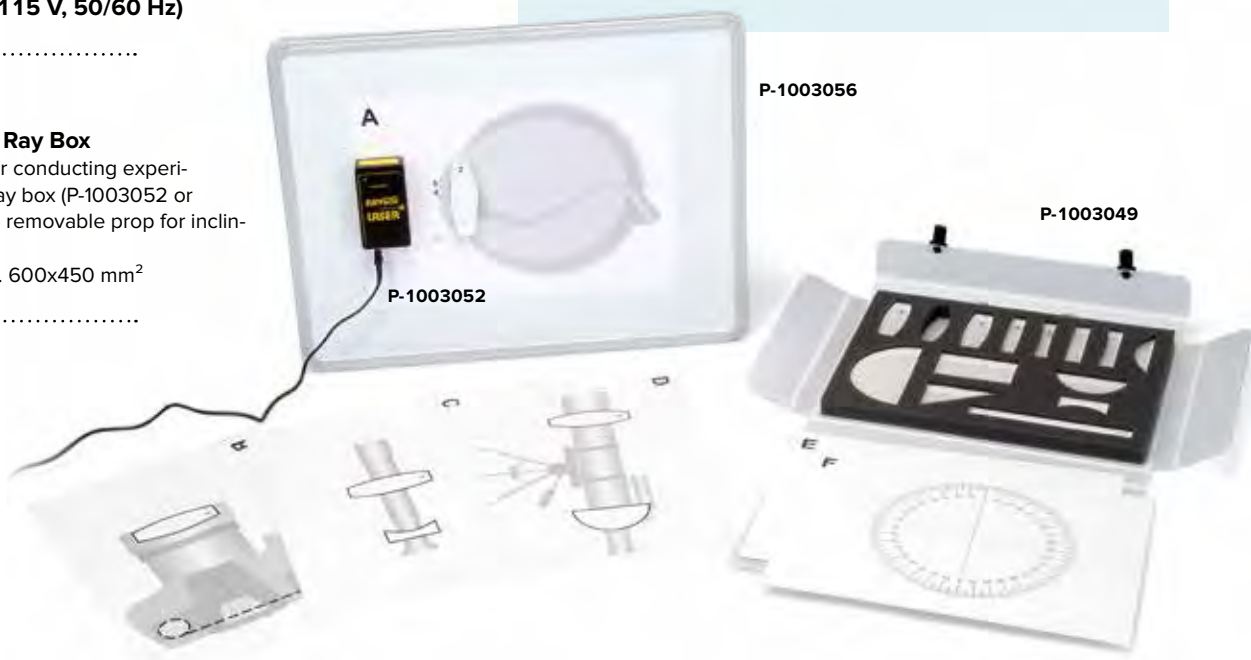

Experiment topics:

- Law of refraction
- Law of reflection
- Total reflection
- Determining the focal length of curved mirrors and lenses
- Lens laws
- Correction of spherical aberration
- Short-sightedness and long-sightedness of the human eye and the correction of such defects
- Beam paths in cameras, microscopes and telescopes

Equipment Set Optics with Laser Ray Box

Set of optical components for use in combination with a laser ray box (P-1003052 or P-1003051) and related board (P-1003056). This equipment set is ideal for conducting a wide variety of experiments on ray optics. Equipped with magnetic foil, the components can be easily attached to the board and aligned. Six work templates with pre-defined positions facilitate experiment setup. The beam paths can be observed from a relatively long way away without any need for darkening the room.

Basic length: 100 mm each (in most cases)

Thickness: 15 mm each

Contents:

- | | |
|------------------------------|---|
| 1 Biconcave lens | 1 Convex mirror |
| 4 Biconvex lenses | 1 Flat parallel block (60x100 mm ²) |
| 1 Plano-concave lens | 1 Prism |
| 1 Hemispherical body (45 mm) | 1 Wave guide (20x200 mm ²) |
| 1 Hemispherical body (75 mm) | 6 Work sheets (410x290 mm ²) |
| 1 Plane mirror | 1 Experiment guide |
| 1 Concave mirror | |

P-1003049

Additionally required:

P-1003052 Laser Ray Box (230 V, 50/60 Hz)

or

P-1003051 Laser Ray Box (115 V, 50/60 Hz)

P-1003056 Board for Laser Ray Box

Laser Optics Supplemental Set with Laser Ray Box

Supplementary kit to the demonstration laser optic set with laser ray box, consisting of 13 optical components for more advanced experiments on geometric optics, e.g. experiments using air lens that show why optical elements cause either negative or positive refraction. All components are coated with magnetic foil.

Base length: 100 mm each (in most cases)

Thickness: 15 mm each

Contents:

- | | |
|--------------------------------|--------------------------------------|
| 1 Biconcave lens | 2 Flat parallel blocks (rectangular) |
| 1 Biconvex lens | 2 Plane mirror |
| 1 Equilateral prism | 1 Biconcave "air lens" |
| 2 Rectangular prisms | 1 Biconvex "air lens" |
| 1 Flat parallel block (square) | 1 "Air prism" |

P-1003050



Experiment topics:

- Focal point of a converging lens
- Focal length
- Diverging lens
- Prism
- Parallel block



P-1003187

Five-Beam Optical Halogen Lamp 12 V, 55 W

Bright light source with five parallel light apertures for experiments involving ray optics to be conducted on a lab bench. In metal housing with integrated ventilation fan. Includes an adjustable reflecting mirror for setting the beam length. Thanks to a magnetic foil the lamp can also be used on a whiteboard.

Halogen lamp: 12 V, 50 W
 Connection: 4 mm safety sockets
 Slit width: 2 mm
 Slit spacing: 18 mm
 Housing dimensions: approx. 210x118x85 mm³

P-1003187

Set of Optical Components

In conjunction with the five-beam optical lamp (P-1003187), this equipment set is intended for experiments introducing students to geometric optics. The optical components are made of acrylic glass. Height: 15 mm each

Contents:

- | | |
|----------------------|------------------------|
| 1 Planar-convex lens | 1 Irregular prism |
| 2 Bi-convex lenses | 1 Plane-parallel plate |
| 1 Bi-concave lens | 1 Semicircular element |
| 1 Equilateral prism | 1 Cylindrical lens |
| 1 Rectangular prism | |

P-1002993



P-1002993

Additionally required:

- P-1000593 Transformer 12 V, 60 VA (230 V, 50/60 Hz)**
 or
P-1006780 Transformer 12 V, 60 VA (115 V, 50/60 Hz)
P-1002993 Set of Optical Components

Experiment topics:

- Reflection and refraction of light by semicircular elements and prisms
- Snell's law
- Critical Angle



P-1003058
P-1003057

Optical Disc with Diode Laser

Set of apparatus for a comprehensive and easily understandable introduction to the basic principles of refraction and reflection of light by means of demonstration or student experiments. The laser can be easily attached via its built-in magnet and aligned on the end of the metal base. The rotating optical disc has an angular scale with 1° divisions and marked lines to position the elements. The set includes a semi-circular disc and an equilateral prism for use in optical experiments, as well as a plug-in mains-adaptor power supply and a battery compartment (batteries are not included in the apparatus as supplied).

Diode Laser: 1 beam, Class II
 Output power: <1 mW
 Wavelength: 635 nm
 Operating voltage: 3 V DC
 Battery-box: for 2x 1.5 V batteries (AA, LR6, MN1500, Mignon)

Laser ray box: 80x25x21 mm³
 Metal base: 320x40x35 mm³
 Optical disc: 250 mm diam.
 Semicircular element: 90 mm diam.
 Prism: 100 mm equilateral

Optical Disc with Diode Laser (230 V, 50/60 Hz)

P-1003058

Optical Disc with Diode Laser (115 V, 50/60 Hz)

P-1003057

Additionally recommended:

P-1003191 Semicircular Cell

P-1003191



Semicircular Cell

Graduated cell with 1 mm scale division, made of acrylic glass.
 Dimensions: 200 mm diam.
 Height: 20 mm

P-1003191

With a dependability that has been proven over the course of decades, the Kröncke optical system provides the precision necessary for student exercises and practical experiments in a wide range of experiments on ray optics and wave optics.

All optical components are mounted in diaphragms with no stem and can easily be moved up and down on an optical rider, perpendicular to the popular optical axis for the purpose of precise adjustment. The optical riders can be freely moved along the optical bench's U-shaped profile and secured by means of a simple clamping mechanism.

Optical Bench K

Optical bench made of black anodised aluminium profile with printed millimetre scale.

Cross-section: approx. 70x30 mm

Art. No.	Length	Weight
P-1009699	2000 mm	2.4 kg
P-1009696	1000 mm	1.2 kg
P-1009926	500 mm	0.6 kg

Advantages

- Rugged design
- Rapid set-up
- Extensive accessories



Optical Lamp K

Halogen lamp in cylindrical housing attached to diaphragm screen (100x100 mm²) for mounting on optical rider K (P-1000862).

The filament can be aligned horizontally or vertically.

Halogen lamp: 12 V, 20 W

Terminals: 4 mm safety sockets

Dimensions: approx. 60x100x100 mm³

Weight: approx. 130 g

P-1000863

Additionally required:

P-1000866 Transformer 12 V, 25 VA
(230 V, 50/60 Hz)

or

P-1000865 Transformer 12 V, 25 VA
(115 V, 50/60 Hz)



P-1000863

Halogen Lamp 12 V/20 W (not shown)

Special substitute lamp for the optical lamp K (P-1000863).

P-1003533

Micrometer Screw K

Micrometer screw with fine tip for measuring diffraction and interference lines. Holder fits the optical rider K (P-1000862).

Dimensions: approx.
80x30x60 mm³

Weight: approx. 120 g

P-1000887

Plane Mirror K

Simple plane mirror, glass.

Dimensions: 100x100 mm²

Weight: approx. 70 g

P-1003532

Optical Rider K

Optical rider for K-model optical benches (P-1009699, P-1009696 and P-1009926). With two clamps for diaphragms from the Kröncke optical system or for plates up to 2 mm thick.

Dimensions: approx. 40x50x35 mm³

Weight: approx. 70 g

P-1000862

Prism Table K

Prism table with clip for clamping prisms. Holder fits the optical rider K (P-1000862).

P-1000876



P-1000876

Concave Mirror K

Concave mirror on diaphragm screen 100x100 mm².

Focal length: 180 mm

Mirror diam.: 32 mm

Dimensions: 100x100 mm²

P-1009925

Iris Diaphragm K

Continuously adjustable iris on diaphragm screen 100x100 mm².

Aperture: 2 – 18 mm

Dimensions: 100x100 mm²

P-1000850



P-1000887



P-1003532



P-1009925

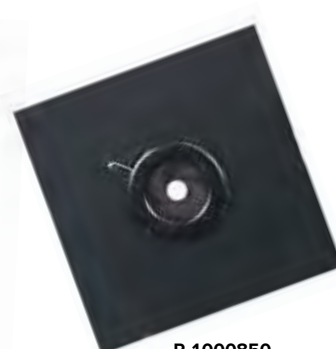

P-1000850

Optical Lenses K

Lenses made of high-grade optical glass. Shock-proof and crack-proof installation in optical diaphragm (100x100 mm²). With focal length specification.
 Dimensions: 100x100 mm²
 Lens diameter: 32 mm



P-1000869 – P-1009863

Art. No.	Designation
P-1000869	Convex Lens K, f = 50 mm
P-1010300	Convex Lens K, f = 100 mm
P-1000871	Convex Lens K, f = 150 mm
P-1009861	Convex Lens K, f = 200 mm
P-1009866	Convex Lens K, f = 300 mm
P-1009863	Convex Lens K, f = 500 mm
P-1009864	Concave Lens K, f = -100 mm
P-1009865	Concave Lens K, f = -500 mm



P-1009864 – P-1009865



P-1003571



P-1009927

Fresnel Mirror K

Fresnel mirror with holder for use on K-model optical benches (P-1009699, P-1009696 or P-1009926). Two mutually inclined surface-coated mirrors are bonded to a common metal plate. A knurled screw at the rear can be used to adjust the angle between the mirrors. The wave nature of light can be demonstrated by interference following reflection at both mirrors. Holder matches the optical rider K (P-1000862).

Dimensions: 135x100x40 mm³
 Weight: approx. 123 g

P-1009927

Clamp K

Tough clamp for diaphragms, filters, diffraction objects and other objects in a slide frame (see as of page 161). On diaphragm screen 100x100 mm². Clamping range: 0.2 – 4 mm
 Dimensions: 100x100 mm²
 Round opening: 38 mm diam.

P-1008518

Adjustable Slit K

Continuously adjustable slit on diaphragm screen (100x100 mm²). The slit width can be adjusted by means of a micrometer screw.
 Slit width: 0 – 3 mm
 Slit height: 25 mm
 Dimensions: 100x100 mm²
 Weight: approx. 240 g

P-1008519

Storage Box

Box made from smoked beech, varnished, with 20 compartments for lenses and optical elements of width 100 mm.

Dimensions: 400x130x90 mm³

Weight: approx. 1,000 g

P-1003571

Projection Screens K

(not shown)
 Plastic projection screens for mounting on optical rider K (P-1000862).
 Dimensions: 200x150 mm²

Projection Screen K, transparent

P-1000878

Projection Screen K, white

P-1000879

Holder K for Diode Laser

Magnetic holder for diode laser (P-1003201 or P-1003202). On diaphragm screen 100x100 mm².

P-1000868

Pair of Polarsation Filters K

Two polarising filters on a diaphragm screen (100x100 mm²) for producing and analysing polarised light. In a rotating frame with a pointer and protractor scale.

Scale: 0 – 180°

Scale division: 5°

Dimensions: 100x100 mm²

Filter diameter: 32 mm

P-1009929



P-1008518

P-1008519

P-1009929

P-1000868

The inexpensive NEVA optics system offers reliability and ease of use for setting up basic experiments in ray optics.

All the optical components are set in a slide with a magnetic base and can easily be aligned on a sturdy optical base and moved into a beam of light.



P-4003987

Optical Bench N

Metal rail with millimetre scale and guide slots for accommodating optical components on a magnetic base.

Dimensions: 400x75x10 mm³
Weight: 230 g approx.

P-4003987

Optical Lamp N

High-powered white LED in a plastic housing with a magnetic base. Includes 5-V-DC, 1000-mA plug-in power supply.

Dimensions: 90x70x70 mm³
Weight: 200 g approx.

Optical Lamp N (230 V, 50/60 Hz)

P-1009946

Optical Lamp N (115 V, 50/60 Hz)

P-1009945



P-1009946

Optical Lenses N

Lenses made of high-quality optical glass. Breakage and impact-resistant, set in a slide with magnetic base.

Dimensions: 70x70 mm²
Lens diameter: 36 mm

Art. No.	Designation
P-1000843	Convex Lens N, f = +50 mm
P-1000842	Convex Lens N, f = +100 mm
P-1000841	Convex Lens N, f = +300 mm
P-1000844	Concave Lens N, f = -100 mm



P-1000841 - P-1000844



P-1006791

Parallel Light Optical Lamp N

Light source for parallel and divergent beams based on a high-powered white LED in a plastic housing with a magnetic base. The outlet side for parallel light has a slot for a slide and there is also a side for outputting divergent beams. Includes 5-V-DC, 1000-mA plug-in power supply.

Dimensions: 90x70x70 mm³
Weight: 400 g approx.

Parallel Light Optical Lamp N (230 V, 50/60 Hz)

P-1006791

Parallel Light Optical Lamp N (115 V, 50/60 Hz)

P-1006790

Projection Screen N

Angled, white-painted metal projection screen for horizontal or vertical use or placement beyond the N-model optical bench (P-4003987).

Screen area: 120x170 mm²

P-1012891

Object Holder N

Object holder with magnetic base to accommodate optical apertures in slides (50x50 mm²), e.g. single slit N (P-4004002) or triple/quintuple slit N (P-4004057).

P-1000845



P-1012891

P-1000845

Single Slit N

Single slit slide for mounting in N-model object holder or in the filter slot of the N-model parallel light optical lamp to use in optical experiments requiring a tight single beam.

Dimensions: 50x50 mm²

P-4004002

Triple/Quintuple Slit N

Slide with a triple and a quintuple slit arrangement for mounting in N-model object holder (P-1000845) or in the slide slot of the N-model parallel light optical lamp (P-1006791 or P-1006790) to use in optical experiments requiring multiple tight beams.

Dimensions: 50x50 mm²

P-4004057

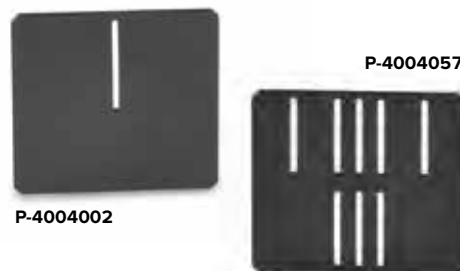

P-4004002

P-4004057

Experiment topics:

- Demonstration of various light beams
- Reflection of a light ray by a plane mirror
- Reflection of a beam of rays by a plane mirror
- Reflection of a beam of rays by a concave/convex mirror
- Snell's law of refraction
- Refraction by a plane-parallel plate
- Refraction by a prism
- Inverting prism
- Concave and convex lenses

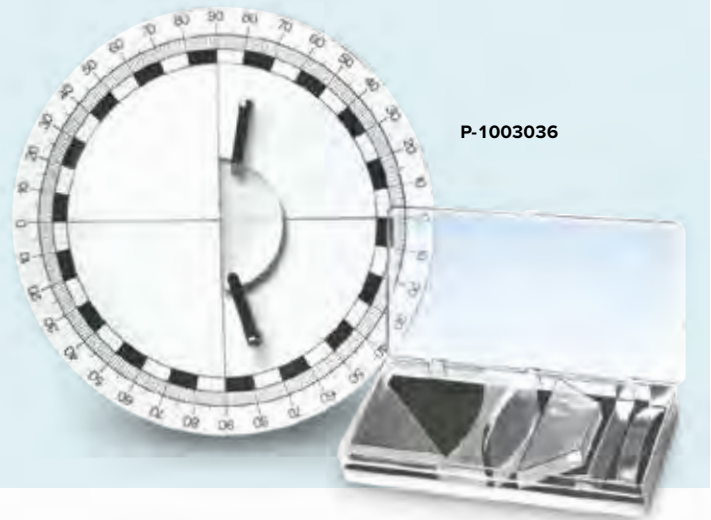

Optical Disc with Accessories

This equipment set introduces the fundamentals of geometric optics. It consists of a base plate with an angular scale possessing 1° divisions, a block scale and two bore holes for mounting clamps for optical components (lenses, prisms, mirrors). An adjustable holder and tripod permit horizontal as well as vertical installation.

Delivered with a storage case, this equipment set comprises the following items:

- 1 Optical disc with a holding stem and 2 clamps, 240 mm diam.
- 1 Bi-concave lens, 90 mm
- 1 Bi-convex lens, 90 mm
- 1 Semi-circular element, 90 mm
- 1 Trapezoid element, 45° and 60°
- 1 Prism, rectangular, leg length 50 mm
- 1 Combined mirror (planar, convex, concave)

P-1003036

Optical Rider U

Optical rider for U-model optical benches (P-1003039 and P-1003040) for mounting optical attachments on a stem. A smooth base ensures easy movement on the optical bench. Clamping width for stems: 10 mm

Art. No.	Sleeve height
P-1003041	75 mm
P-1003042	30 mm

Optical bench U

Comprising a solid aluminium profile, anodised with natural finish, robust and resistant to twisting, with mm scale along the full length. For experiments with optical attachments on a stem. Cross-section: approx. 100x40 mm²

Art. No.	Length	Scale length	Weight
P-1003039	1200 mm	1000 mm	approx. 3.0 kg
P-1003040	600 mm	500 mm	approx. 1.5 kg

Additionally recommended:

- P-1003039 Optical bench U, 120 cm
- P-1003041 Optical rider U, 75 mm (3x)
- P-1003042 Optical rider U, 30 mm
- P-1003038 Experiment lamp, halogen
- P-1000855 Object holder on a stem
- P-1003024 Convex lens, $f = +150$ mm
- P-1000607 Set of slits and apertures
- P-1000593 Transformer 12 V, 60 VA (230 V, 50/60 Hz) or
- P-1006780 Transformer 12 V, 60 VA (115 V, 50/60 Hz)

Pair of Rail Supports

Two support feet made of natural-finish, anodised aluminium for U-model optical benches (P-1003039 and P-1003040). Dimensions: 220x20x15 mm³

P-1003044

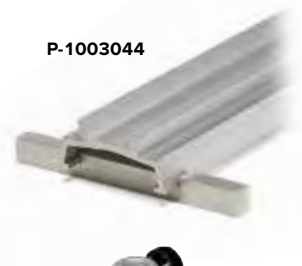

Swivel Joint with Scale

Connecting piece for articulated linking of two U-model optical benches (P-1003039 and P-1003040). Profile rails. 90° articulation angle in both directions. Natural-finish, anodised aluminium. With a mounting for optical attachments on a stem at the axis of rotation. Clamping width for stems: 10 mm. Scale division: 5°. Dimensions: 180x82x100 mm³

P-1003043

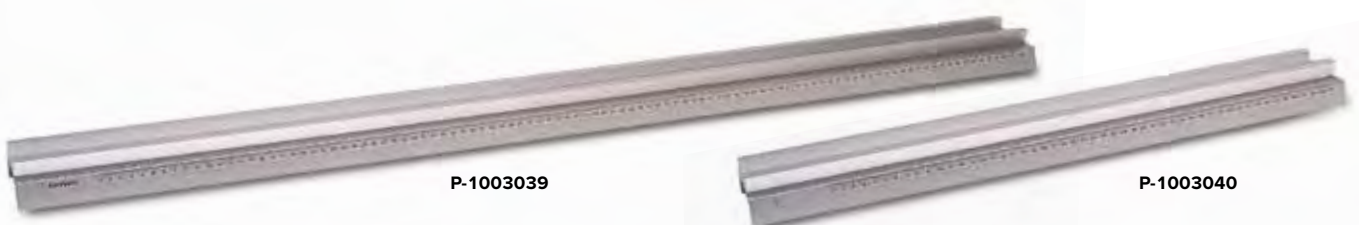

P-1002629

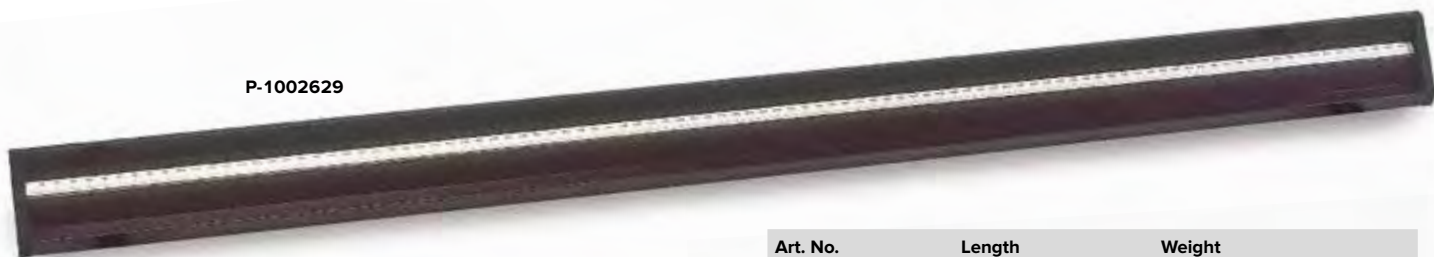

Advantages

- Durability
- Tough, three-sided profile
- Millimetre precision

Optical Precision Bench D

Optical precision bench with a triangular profile for research and demonstration experiments requiring maximum accuracy. Made of black, anodised aluminium. Tilt-proof, slip-proof, resistant to bending and twisting, equipped with a full-length scale with cm/mm divisions. Bore holes on front end for securing connecting elements for additional rails or swivel joint (P-1002632).
Cross-section: approx. 90x60 mm³

Art. No.	Length	Weight
P-1002630	500 mm	approx. 1.75 kg
P-1002628	1000 mm	approx. 3.5 kg
P-1002629	2000 mm	approx. 7 kg



P-1002628

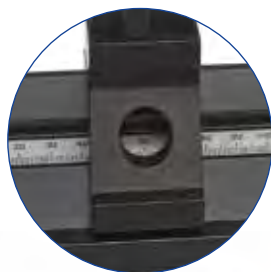

Optical Rider D

Optical rider for D-model precision optical benches (P-1002628, P-1002629 and P-1002630) for mounting optical attachments on a stem. For research and demonstration experiments requiring maximum accuracy. Made of black anodised aluminium. Thanks to a hole drilled in the middle of the base and an accompanying scale, it is possible to read off the position of the centre of the rider on the optical bench directly. The riders are preliminarily fixed to the optical bench via springy built-in plastic nipples until the grub screw is tightened. Long-term attachment is designed to protect the materials using a stainless steel pressure shoe rather than the point of a screw. The stems of the optical equipment placed on the bench are also designed to protect the materials in that they are clamped using a stainless bracket.

Clamping width for rods: 10 – 14 mm

Art. No.	Sleeve height	Base width
P-1012400	60 mm	50 mm
P-1002635	90 mm	50 mm
P-1002637	120 mm	50 mm
P-1002639	60 mm	36 mm
P-1012401	90 mm	36 mm
P-1012402	120 mm	36 mm



P-1012400

P-1002635

P-1002637

Sliding Rider D

Optical rider with a mounting for optical attachments on a stem, adjustable vertically with respect to the optical axis. Sliding rider with micrometer screw for position adjustment.

Sliding range: ±12.5 mm
Sleeve height: 90 mm
Base width: 50 mm
Clamping width for rods: 10 – 14 mm

P-1002644



P-1002644

Tilting Rider D

Optical rider for tilting optical elements out of the optical axis.

Sleeve height: 90 mm
Base width: 50 mm
Clamping width for rods: 10 – 14 mm
Tilting range: 90°

P-1012467



P-1012467

Support for Optical Bench D

One rail support and a single-point support with screws for adjusting optical bench. Made of black, anodised aluminium.
Length of rail support: 270 mm

P-1012399



Swivel Joint for Optical Bench D

For experiments where light is deflected and where the highest precision requirements prevail. Black anodized aluminum with adjustable protractor scale $\pm 180^\circ$ in 1° divisions. Sleeve for holding optical elements shaft mounted.

Protractor scale: $\pm 90^\circ$
Sleeve height: 60 mm
Clamping width for rods: 10 – 14 mm

P-1002632



Optical Base D

Optical base used for mounting a U-shaped transformer core (P-1000979) with coils and pole terminals for conducting experiments on the Faraday effect using precision optical bench D (P-1002628).
Dimensions: 148x85x60 mm³ approx.

P-1009733



Extension Arm D

Extension Arm to clamp on an optical rider D, for positioning optical elements out of the optical axis.

Extension arm: 100 mm
Clamping width for rods: 10 – 14 mm

P-1002646

Optical Lamp, Halogen

Ultra-bright light source for experiments on optical bench and for projection. It consists of a metal housing with a condenser, a movable element for axial light adjustment, a holding stem with a screw mounting and an integrated fan.

Halogen lamp: 12 V, 50 W
Connection: via 4 mm safety jacks
Condenser focal length: 75 mm
Condenser diameter: 45 mm
Stem: 120 mm x 10 mm diam.
Housing: approx. 190x125x110 mm³

P-1003188

Additionally required:
P-1000593 Transformer 12 V, 60 VA (230 V, 50/60 Hz)
or
P-1006780 Transformer 12 V, 60 VA (115 V, 50/60 Hz)

Spare Halogen Lamp, 12 V, 50 W

(not shown)
Spare halogen lamp for optical lamps (P-1003038 and P-1003188).

P-1002837



Experimental Lamp, Halogen

Light source with low-divergence beam for optical experiments. Black-painted metal housing on a stem, with fixture for vertical or horizontal set-up.

Halogen lamp: 12 V, 50 W
Connection: via 4 mm safety sockets
Light aperture: 40 mm diam.
Shaft diameter: 10 mm
Dimensions: approx. 80x80x105 mm³

P-1003038

Additionally required:
P-1000593 Transformer 12 V, 60 VA (230 V, 50/60 Hz)
or
P-1006780 Transformer 12 V, 60 VA (115 V, 50/60 Hz)



P-1003201

Laser Diode, Red

Red light source giving a beam with minimal divergence, housed in a compact and sturdy aluminium body. It is based on a 650 nm class II industrial laser module with a glass collimating lens. Fitted with a 10 cm stainless steel rod. A 100-230V AC/DC converter is included.

Laser protection class:	II
Output power:	0.9 – 1 mW at 20° C
Wavelength:	650 nm ± 5 nm
Spot size at 5 m distance:	< 8 mm diam.
Divergence:	< 1 mrad
Operating voltage:	6 – 12 V DC

P-1003201

Achromatic Objective – 10x/0.25

Microscope objective for diverging beam in conjunction with He-Ne laser P-1003165.

P-1005408

Objective for Beam Divergence

Microscope objective 4x mounted on an adapter for diverging the beam in conjunction with the red laser diode (P-1003201) or the green laser module (P-1003202).

P-1000675



Divergence of laser beam by a microscope objective.



P-1000675

He-Ne Laser

Monochromatic, coherent light source for optical experiments, e.g. on diffraction, interference, and hologram reconstitution. Anodised metal housing with key switch, neutral filter for attenuating beam, 2 stand rods and power supply unit. To widen the beam, microscope objectives (e.g. P-1005408) can be screwed to the beam aperture.

Laser protection class:	II
Output power:	< 0.2 mW (with neutral grey filter) < 1 mW (without neutral grey filter)
Wavelength:	633 nm
Beam diameter:	0.48 mm
Radiation divergence:	1.7 mrad
Mode:	TEM ₀₀
Polarisation:	Random
Service life:	> 12000 hours
Plug-in power supply:	12 V DC, 1 A
Dimensions:	approx. 230x55x90 mm ³
Weight:	approx. 0.8 kg

Contents:

- 1 Helium-Neon Laser
- 2 Keys
- 1 Long stand rod
- 1 Short stand rod, 6-edges
- 1 Transformer 12 V

P-1003165



P-1003202

Laser Module, Green

High performance 532 nm green laser (doubled NdYag). The laser (safety classification II) produces green light ideally suitable for optical demonstrations, as the wavelength is in the range where the human eye has maximum sensitivity. The visibility is as good as that for red laser light from a 5 mW source. Fitted with a 10 cm stainless steel stem. The apparatus supplied includes a plug-in mains-adaptor power supply.

Laser protection class:	II
Output power:	0.4 – 1 mW at 20° C
Wavelength:	532 nm ± 0.1 nm
Spot size at 5 m distance:	< 9 mm diam.
Divergence:	< 2 mrad
Operating voltage:	3 V DC

P-1003202

E14 Lamp Socket on Stem

E14 lamp socket on stem, with mains connection cable and Euro-plug conforming to CEE 7/16.

Shaft:	113 mm x 10 mm diam.
Weight:	approx. 135 g

P-1000853

E27 Lamp Socket on Stem

E14 lamp socket on stem, with mains connection cable and earthed plug conforming to CEE 7/4.

Shaft:	113 mm x 10 mm diam.
Weight:	approx. 240 g

P-1000854



P-1000853

P-1000854



P-1003165

Note:

All the components on stems illustrated on the following pages are supplied without an optical rider.

Lenses on Stem

Lenses in black frame on stem. With a lens protection ring for preventing damage to the lens.

Holder: 130 mm diam.

Shaft: 10 mm diam.

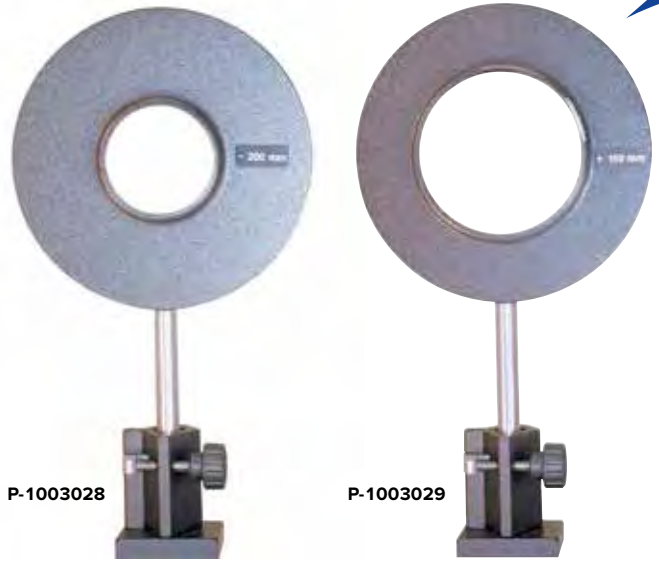

Art. No.	Designation	Focal length	Diaphragm diameter
P-1003022	Convex lens on stem	+50 mm	50 mm
P-1003023	Convex lens on stem	+100 mm	50 mm
P-1003024	Convex lens on stem	+150 mm	50 mm
P-1003025	Convex lens on stem	+200 mm	50 mm
P-1003026	Convex lens on stem	+300 mm	50 mm
P-1003029	Convex lens on stem	+150 mm	75 mm
P-1003027	Concave lens on stem	-100 mm	50 mm
P-1003028	Concave lens on stem	-200 mm	50 mm

Mirrors on Stem

Mirrors in black metal frame on stem. With protective ring for preventing damage to mirror.

Holder: 130 mm diam.

Diaphragm: 50 mm diam.

Shaft: 10 mm diam.

Art. No.	Designation	Focal length
P-1003031	Concave mirror, on stem	+75 mm
P-1003032	Convex mirror, on stem	-75 mm
P-1003033	Plane mirror, on stem	-

Variable Focus Lens

Transparent silicone lens, on stem. The radius of curvature of the soft silicone lens can be adjusted via the water pressure in the lens using a plastic syringe, e.g. for demonstrating the accommodation capacity of the eye. Includes plastic syringe and connecting tube.

Holder: 130 mm diam.

Lens: 65 mm diam.

Shaft: 10 mm diam.

P-1003030



P-1000857



P-1003016



P-1003203



P-1008668



P-1000856



P-1000855

Component Holder on Stem

Holder on steel rod for supporting an optical component of circular shape. The component is held in place by a metal ring.

Aperture: 36 mm diam.
 Components: 7 mm x 42 mm diam. max.
 Height of optical axis: 150 mm
 Mounting: 100 mm diam.
 Stem: 10 mm diam.

P-1003203

Object Holder on Stem

Object holder in black metal frame on stem. With plug-in frame for diaphragms, filters, diffraction gratings and other objects in slide frame (see as of page 161). Includes panels to partially cover the inserted objects.

Metal frame: 130 mm diam.
 Plug-in socket: 50x50 mm²
 Shaft diameter: 10 mm

P-1000855

Rotating Object Holder on Stem

Object holder in black metal frame on stem. With rotating, plug-in frame for diaphragms, filters, diffraction gratings and other objects in slide frame (see as of page 161) with protractor scale.

Holder: 130 mm diam.
 Plug-in frame: 50x50 mm
 Angular scale: $\pm 90^\circ$
 Divisions: 5°
 Shaft: 10 mm diam.

P-1003016

Polarisation Filter on Stem

Precision glass polarisation filter, which is in a mounting on a steel rod and can be rotated on a ball-bearing. With angular scale marked in 1° intervals.

Aperture: 38 mm diam.
 Extinction coefficient: $>99.9\%$ at $\lambda = 450 - 750$ nm
 Height of optical axis: 150 mm
 Mounting: 100 mm diam.
 Stem: 10 mm diam.

P-1008668

Adjustable Slit on Stem

Slit with symmetric aperture, in black metal frame on stem. With micrometer screw.

Holder: 130 mm diam.
 Slit width: 0 – 3 mm
 Slit height: 25 mm
 Shaft: 10 mm diam.

P-1000856

Total Reflection Apparatus on Stem

Acrylic rod with bend in black metal frame on stem. Parallel light shone through the rod undergoes total internal reflection and is guided around the bent end.

Metall holder: 130 mm diam.
 Shaft: 10 mm diam.

P-1000857



P-1003164



P-1003017



P-1000608



P-1012863

Holder on Stem for Lenses without Frame

Holder with a clamp for mounting frameless lenses. In black metal frame on stem.

Holder : 130 mm diam.
Aperture: 40 mm diam.
Shaft: 10 mm diam.

P-1003164

Projection Screen

Translucent screen, on stem, for all projection purposes on optical bench.

Dimensions: 250x250 mm²
Shaft: 10 mm diam.

P-1000608

Iris on Stem

Iris diaphragm in black metal frame, shaft-mounted. Continuously adjustable diaphragm diameter.

Holder: 130 mm diam.
Iris diameter: 3 – 29 mm
Shaft: 10 mm diam.

P-1003017

Holder on Stem for Direct-Vision Prism

Holder with rotating mounting for direct-vision prism (P-1002862). In black metal frame on stem.

Holder: 130 mm diam.
Shaft: 10 mm dia

P-1012863

Prism Table on Stem

Round prism table with a height-adjustable clamp, e.g. for fixing prisms. On stem for mounting on optical rider.

Table: 60 mm diam.
Shaft: 10 mm diam.

P-1003019



P-1003019

Storing Base for Lenses

Wooden strip with ten bore holes for storing instruments with 10 mm-shaft.

P-1003034



P-1003034



UE4030350
PDF online



P-1008669

Glass Inset for Newton's Rings Experiments

Optical component for demonstrating and investigating Newton's interference rings. Composed of flat and curved glass pane on a stem. Includes three adjustment screws for centring the interference module.

Height of optical beam: 150 mm
Usable diameter: 38 mm
Thickness of glass pane: 3 mm
Radius of curvature: 50 m
Diameter of setting: 100 mm
Diameter of stem: 10 mm

P-1008669

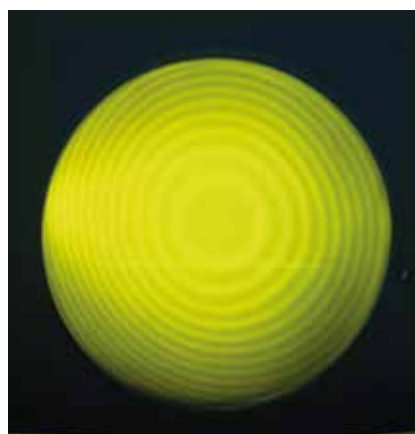

Newton's rings
in yellow light



P-1002649

Fresnel Mirror on Stem

This device is used to demonstrate the wave nature of light by observing interference caused by reflection at two mirrors and can be used to calculate the wavelength of light. It consists of two mutually inclined, front-coated mirrors made of black acrylic glass and fitted in black, anodised aluminium holders with firmly mounted mirror protection elements on a tripod made of high-grade steel. The angle of inclination can be finely adjusted from the rear.

Total mirror area: 30x95 mm²
Adjustment range: -0.3° – +0.7°
Shaft: 10 mm diam.

P-1002649

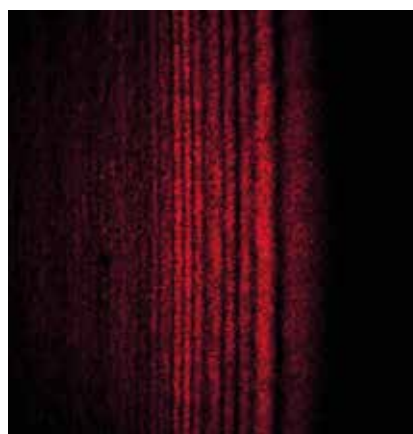

Interference pattern on
the observation screen

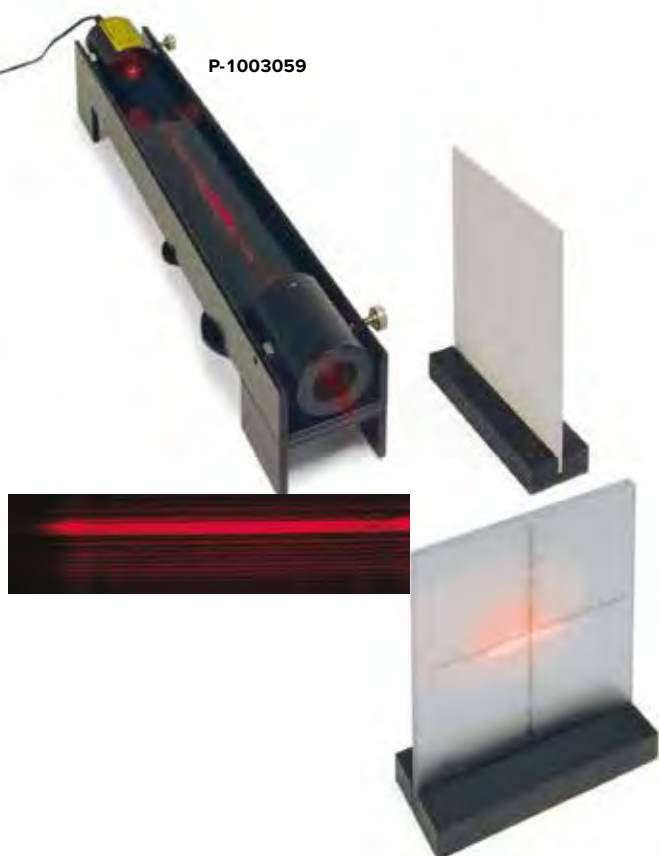

P-1003059

Fresnel Mirror Experiment Set

Complete equipment set for demonstrating the wave nature of light by observing the interference of laser light. This is caused by the reflection of a laser at two black planar glass mirrors which are offset by a small angle of a few degrees. The laser, mirrors and the optical projector are all mounted on a metal base. One mirror is fixed and the other is adjustable to change the angle of inclination. A projection screen, a ground glass screen with scaled crosshairs and a battery box are also included.

Diode Laser: class II
Output power: < 1 mW
Wavelength: 635 nm
Operating voltage: 3 V DC
Battery-box: for 2x 1.5 V batteries (AA, LR6, MN1500, Mignon) (batteries not included)

Dimensions:
Metal base: 400x75x85 mm³
Screens: 150x90x30 mm³

P-1003059

Additionally recommended:
P-1008659 Plug-In Power Supply 3 V DC

Plug-In Power Supply 3 V DC (not shown)
Plug-in mains adaptor to provide electrical power supply for the Fresnel mirror experiment set (P-1003059).

Mains voltage: 100 – 240 V, 50/60 Hz

P-1008659

Geometrical Objects

For fitting on an object holder on a stem (P-1000855), in a rotatable object holder on a stem (P-1003016) or in a clamping holder K (P-1008518).

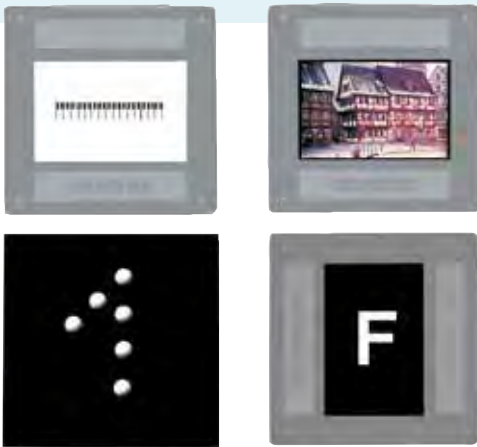

P-1000886

Set of 4 Image Objects

Set of four image objects in a slide frame.

Dimensions: 50x50 mm²

Contents:

- 1 Scale, 15 mm with scale divisions of 0.1 mm
- 1 Photograph
- 1 F diaphragm
- 1 Number 1 diaphragm

P-1000886

Set of 5 Hole Diaphragms

Five hole diaphragms of different diameters in a slide frame.

Hole diameter: 1/ 3/ 6/ 10/ 15 mm

Dimensions: 50x50 mm²

P-1000848

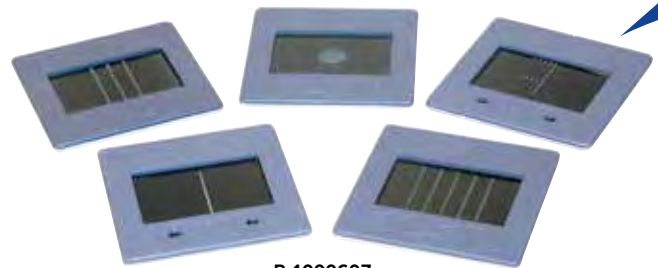

P-1000607

Set of 5 Slit and Hole Diaphragms

Five slit and hole diaphragms in a slide frame.

Dimensions: 50x50 mm²

Contents:

- 1 Slit, slit width 1 mm
- 1 Threefold slit, slit width 1 mm, slit spacing 5 mm
- 1 Fivefold slit, slit width 1 mm, slit spacing 5 mm
- 1 Apertured diaphragm, diam. 8 mm
- 1 F diaphragm

P-1000607

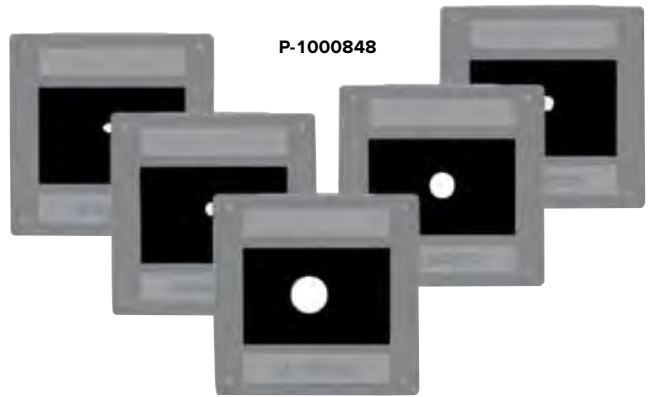

P-1000848

Geometrical Objects

Suitable for mounting in the optical component holder (P-1003203).

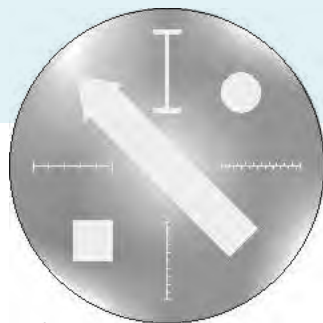

P-1014622

Geometrical Objects on Glass Plate

High quality, chrome-plated glass plate with four scales and three geometrical objects for quantitative experiments on geometric optics. The glass plate is highly resistant against ageing and contamination.

- Diameter: 40 mm
- Thickness: 1.5 mm
- Length of scale: 10 mm
- Graduation: 10 mm, 2 mm, 1 mm, 0.5 mm
- Geometrical objects: Arrow 30 mm long
- Square 5 mm side length
- Disc 5 mm diam.

P-1014622



P-1010031

P-1010030

Frosted Discs

Glass discs with frosted surface. Suitable for use as frosted transparent object in optical experiments.

- Diameter: 40 mm
- Thickness: 2 mm

Frosted Disc with "d"

P-1010030

Frosted Disc

P-1010031

Diffraction Objects

For fitting on an object holder on a stem (P-1000855), in a rotatable object holder on a stem (P-1003016) or in a clamping holder K (P-1008518).

Transmission Grating

Transmission grating for spectroscopic examinations and for experiments on diffraction and interference. Suitable to resolve the Na-D lines. Mounted on glass carrier.

Dimensions: 38x50 mm²

Art. No.	Description	Lines/mm
P-1003080	Transmission Grating	300
P-1003079	Transmission Grating	600



P-1000846

Set of 5 Single Slits

Five single slits of different widths in a slide frame.

Slit widths: 0.1/ 0.2/ 0.4/ 0.8/ 1.6 mm

Dimensions: 50x50 mm²

P-1000846

Polarisation Filter

Set of two polarisation filters in a slide frame.

Dimensions: 50x50 mm²

P-1003328



P-1003328



P-1003177

Hologram

Transmission hologram in slide holder.

Dimensions: 50x50 mm²

P-1003177

P-1003082



Diaphragm with a Single Slit and Rib

Photographic diffraction object in a slide frame.

Slit and rib width: 0.5 mm each

Dimensions: 50x50 mm²

P-1000602



P-1000602

Diaphragm with 3 Single Slits and 1 Double Slit

Photographic diffraction object in a slide frame.

Single slit widths: 0.075 / 0.15 / 0.4 mm

Double slit width: 0.1

Double slit spacing: 0.5 mm

Dimensions: 50x50 mm²

P-1000885



P-1000885

Copy of a Rowland Grating

This copy of a Rowland grating is supplied on a collodion foil between two glass plates in a metal frame for the purpose of projecting diffraction spectra, measuring wavelengths and observing spectra with spectrum lamps.

Number of lines: 600 Lines/mm

Dimensions: 50x50 mm²

P-1002917



P-1002917

Reflection Grating

Reflection grating for demonstrating visible spectra and UV-spectra of 1st and 2nd order and when inclined, of up to 5th order. Mounted on round, concave glass carrier.

Curvature radius: 500 mm

Number of lines: 530 lines/mm

Grating dimensions: 40x30 mm²

Glass carrier: 50 mm diam.

P-1003083

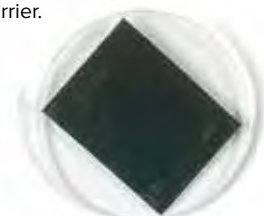

P-1003083

Demonstration Gratings

Three diffraction gratings on a frame for demonstrating the relationship between line spacing and diffraction angle.

Number of lines: 100/ 300/ 600 lines/mm.

Dimensions: 90x30 mm²

P-1003082



Diaphragms with Circular Holes and Discs

Photographic diffraction objects in a slide frame.

Dimensions: 50x50 mm²

Art. No.	Description	Diameter
P-1000603	Diaphragm with 3 Circular Hole and Disc Pairs	1.0/1.5/2.0 mm
P-1000889	Diaphragm with 9 Circular Discs	0.1 – 1.8 mm
P-1000891	Diaphragm with 9 Circular Holes	0.1 – 1.8 mm



Diaphragms with Double and Multiple Slits

Photographic diffraction objects in a slide frame.

Dimensions: 50x50 mm²

Art. No.	Description	Slit spacing	Slit width	No. of slits
P-1000596	Diaphragm with 3 Double Slits of Different Widths	0.3 mm	0.10/0.15/0.20 mm	2
P-1000597	Diaphragm with 4 Double Slits of Different Spacings	0.25/0.50/0.75/ 1.00 mm	0.15 mm	2
P-1000598	Diaphragm with 4 Multiple Slits and Gratings	0.25 mm	0.15 mm	2/3/4/5/40



Diaphragms with Gratings

Photographic diffraction objects in a slide frame.

Dimensions: 50x50 mm²

Art. No.	Description	Grating constant	Slit width	No. of lines
P-1000599	Diaphragm with 3 Ruled Gratings	0.5/0.25/0.125 mm	0.25/0.125/ 0.063 mm	2/4/8 Lines/mm
P-1000600	Ruled Gratings	0.125 mm	0.063 mm	8 Lines/mm
P-1000601	Diaphragm with 2 Cross Gratings	0.25 mm	0.125 mm	4 Lines/mm

Gratings

Line gratings in slide frames. For students and demonstration experiments.

Dimensions: 50x50 mm²

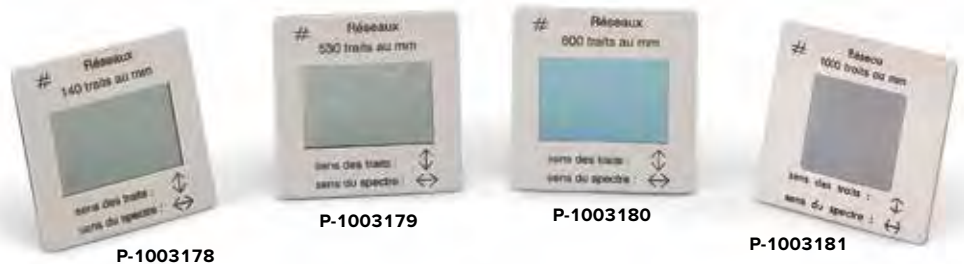

Art. No.	Description	Lines/mm
P-1003178	Grating	140
P-1003179	Grating	530
P-1003180	Grating	600
P-1003181	Grating	1000

Set of 4 Gratings

Four line gratings mounted in slide frame with protective glass plates.

For student and demonstration experiments.

Number of lines: 80/ 100/ 300/ 600 Lines/mm

Dimensions: 50x50 mm²

P-1003081



Diffraction Objects on Glass Plates

Suitable for mounting in the optical component holder (P-1003203). Chromium-coated glass plates with diffraction objects of high precision and regularity applied by microlithography. The glass supports are highly resistant against ageing and contamination.



P-1008664

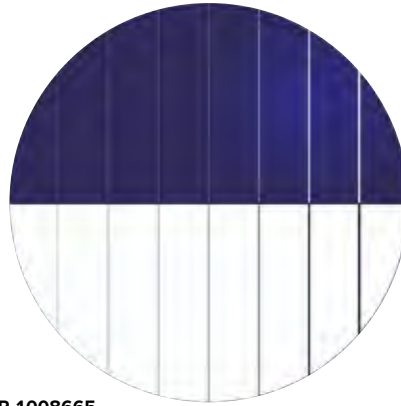

P-1008665

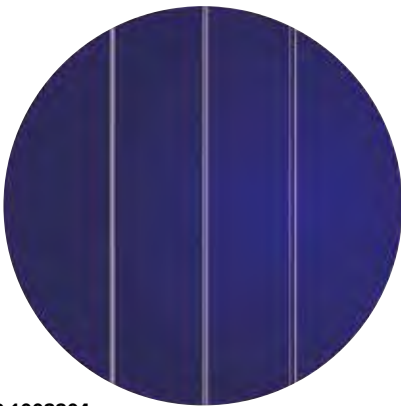

P-1003204

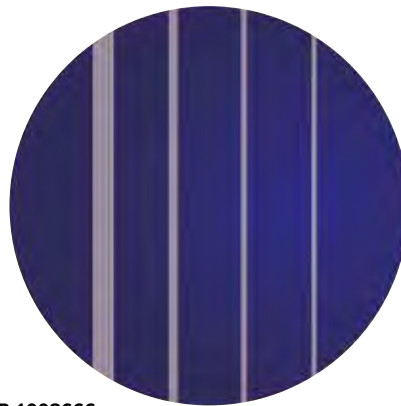

P-1008666

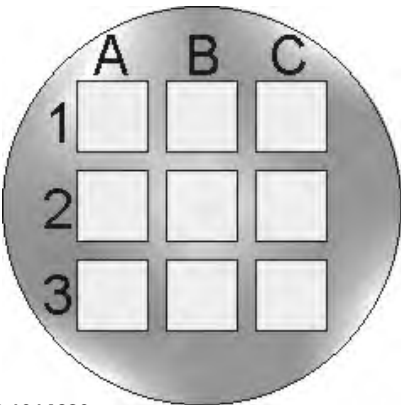

P-1014620

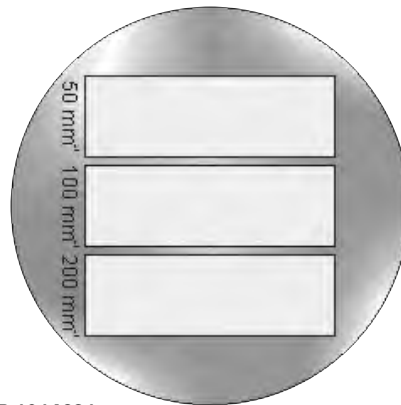

P-1014621

Microstructures on Glass Plate

Glass plate with nine different microstructures consisting of discs, rectangles and squares for quantitative diffraction experiments.

Diameter:	40 mm
Thickness:	1.5 mm
Disc diameters:	30 μm, 50 μm, 100 μm
Rectangles:	10x50 μm, 20x100 μm, 30x150 μm
Squares:	40x40 μm, 70x70 μm, 120x120 μm

P-1014620

Diffraction Gratings on Glass Plate

Glass plate with three diffraction gratings of different number of lines for quantitative diffraction experiments.

Diameter:	40 mm
Thickness:	1.5 mm
Surface:	25x7.5 mm each
Number of lines:	50, 100, 200 / mm
Gratings pitch:	20, 10, 5 μm
Precision:	<1 μm

P-1014621

Diffraction Apertures on Glass Plate

Glass plates with 12 different single and double diffraction apertures for quantitative diffraction experiments.

Diameter of support: 40 mm

Aperture

irregularities: <1 μm

Single apertures:

Diameters: 20, 30, 50, 100, 200 and 500 μm

Double apertures:

Separations: 100, 200 and 400 μm

Diameter: 50 μm

Rectangular

apertures:

Dimensions: 70x70 μm²,
200x200 μm² and
70x200 μm²

P-1008664

Slits and Bars on Glass Plate

Glass plates with 7 sets of slits and bars of different widths for quantitative diffraction experiments.

Diameter of support: 40 mm

Irregularities: <1 μm

Slit widths: 30, 40, 60, 80, 100, 150 and 200 μm

Bar widths: 30, 40, 60, 80, 100, 150 and 200 μm

P-1008665

Double Slits on Glass Plate

Glass plates with three double slits of different separations for quantitative diffraction experiments.

Diameter of support: 40 mm

Irregularities: <1 μm

Slit width: 70 μm

Separations: 200, 300 and 500 μm

P-1003204

Multiple Slits on Glass Plate

Glass plates with four different numbers of multiple slits for quantitative diffraction experiments.

Diameter of support: 40 mm

Irregularities: <1 μm

Slit width: 40 μm

Slit separation: 100 μm

Number of slits: 3, 4, 6 and 14

P-1008666

Colour Filters

For fitting on an object holder on a stem (P-1000855), in a rotatable object holder on a stem (P-1003016) or in a clamping holder K (P-1008518).



P-1003185

P-1003186

Set of 3 Colour Filters, Primary Colours

Set of 3 colour filters, primary colours, in slide frames.

Colours: Red, green, blue
Dimensions: 50x50 mm²

P-1003185

Set of 3 Colour Filters, Secondary Colours

Set of 3 colour filters, secondary colours, in slide frames.

Colours: Cyan, yellow, magenta
Dimensions: 50x50 mm²

P-1003186

Set of 7 Colour Filters

Set of 7 colour filters for experiments on additive and subtractive colour combination. Coloured plastic transparencies fitted in slide frame between glass plates.

Primary colours: Red, blue, green
Secondary colours: Cyan, magenta, yellow and violet
Dimensions: 50x50 mm²

P-1003084



P-1003084

Interference Filters

Suitable for mounting in the optical component holder (P-1003203).



P-1008672

Interference Filters

Narrow frequency-range optical filters for filtering out light of a specific wavelength from a spectrum featuring multiple wavelengths or for making a nearly mono-chromatic light source from a continuous spectrum.

Diameter: 40 mm
Thickness: 3 mm
Precision: 3 nm
Band width (full width half maximum): 10 nm
Transmission: > 60 %
Parasitical transmission: < 1 %

Art. No.	Wavelength	Filtered spectral lines
P-1008671	436 nm	Blue mercury line
P-1008670	546 nm	Green mercury line
P-1008672	578 nm	Yellow mercury doublet

Additionally required:

P-1003203 Component Holder

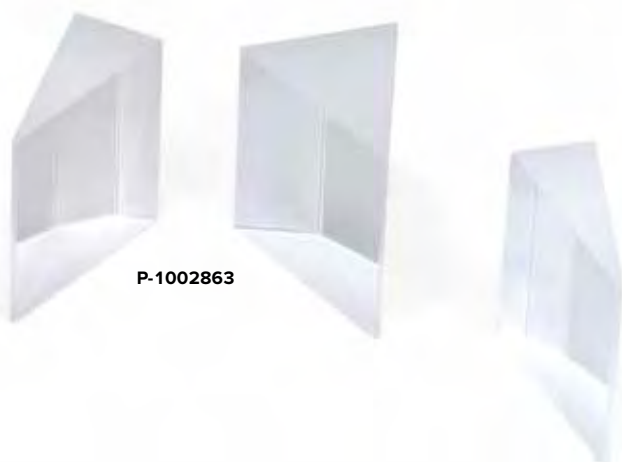
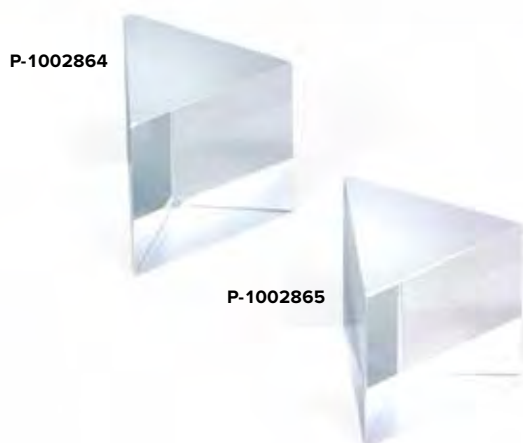
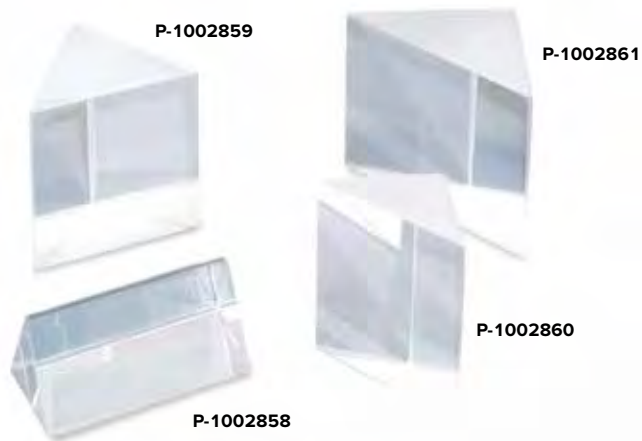

60° Prisms

Equilateral prisms for use on the prism table on shaft (P-1003019) or prism table K (P-1000876).

	P-1002858	P-1002859
Material	Crown glass	Crown glass
Refractive index	1.515	1.515
Side length	27 mm	45 mm
Height	50 mm	50 mm

	P-1002864	P-1002865
Material	Crown glass	Flint glass
Refractive index	1.515	1.608
Average dispersion	0.008	0.017
Side length	30 mm	30 mm
Height	30 mm	30 mm

90° Prisms

Rectangular prisms for use on the prism table on stem (P-1003019) or prism table K (P-1000876).

	P-1002860	P-1002861
Material	Crown glass	Crown glass
Refractive index	1.515	1.515
Side length	30 mm	45 mm
Height	50 mm	50 mm

Set of 3 Prisms

Set of prisms for demonstrating the design of an achromatic prism and a direct vision prism. Consists of a thin flint glass prism, as well as thin and thick crown glass equilateral prisms. The two thin prisms deflect a light beam equally strongly but with different dispersions. Moving them closer together in the light path results in a direct vision prism which decomposes light into its spectral components without deflecting it. The thick crown glass prism has the same dispersion as the flint glass prism, but deflects the light beam twice the distance. This permits configuration of an achromatic prism which deflects light without splitting it into a spectrum.

P-1002863

Material	Flint glass	Crown glass	Crown glass
Refractive index	1.608	1.515	1.515
Average dispersion	0.017	0.008	0.008
Base	15 mm	30 mm	18 mm
Side length	40 mm	40 mm	40 mm
Height	40 mm	40 mm	40 mm

Hollow Prism, Equal-Sided

Equal-sided hollow prism made of optical glass to study diffraction and dispersion of light in liquids. With Teflon stopper on the filling hole.

Length of base: 60 mm_{inside}
 Height: 60 mm_{inside}
 Volume: 89 ml

P-1014618

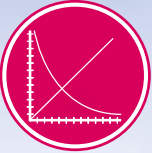
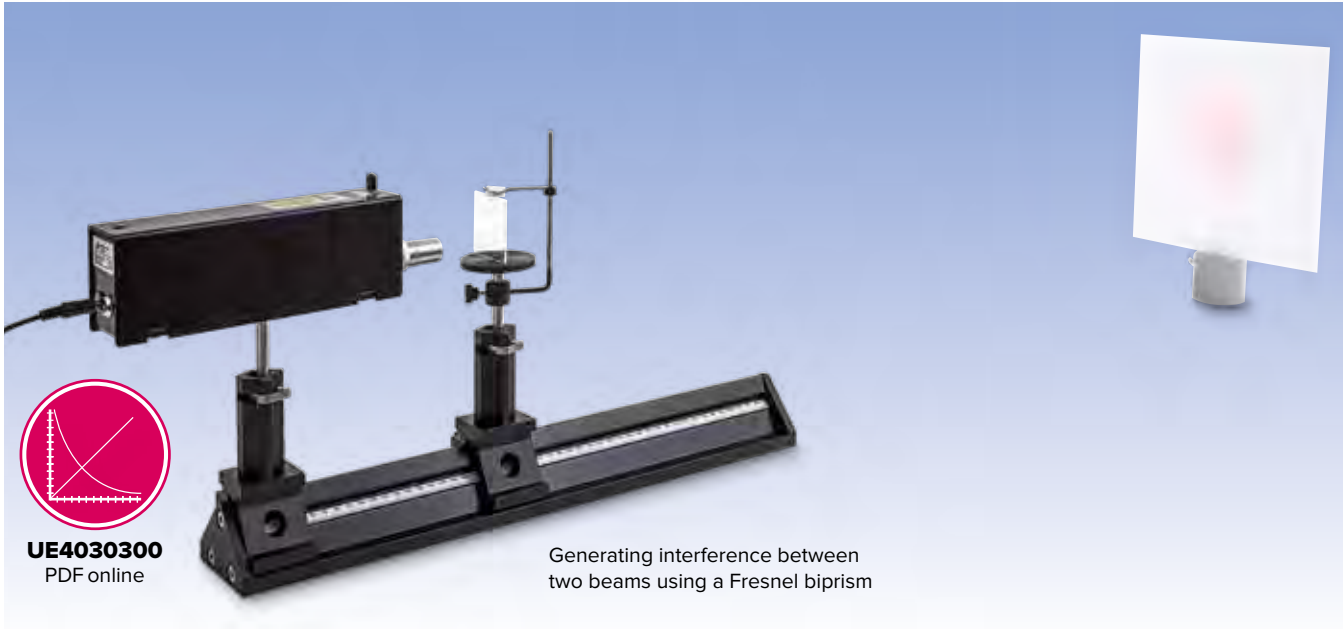

UE4030300
PDF online

Generating interference between two beams using a Fresnel biprism

Fresnel Biprism

Fresnel biprism for observing interference by creating two virtual sources of light by refracting the light from a single coherent source.

Dimensions: 50x50x2 mm³

Prism angle: 179° approx.

Refractive

index: 1.5231

P-1008652



P-1008652

Equipment for Fresnel biprism:

P-1008652 Fresnel Biprism

P-1003019 Prism Table on Stem

P-1003165 He-Ne Laser

P-1005408 Achromatic Objective 10x / 0.25

P-1003025 Convex Lens on Stem f = +200 mm

P-1002635 Optical Rider D, 90/50

P-1002630 Optical Precision Bench D, 50 cm

P-1000608 Projection Screen

P-1002834 Barrel Foot, 1000 g

P-1002603 Pocket Measuring Tape, 2 m

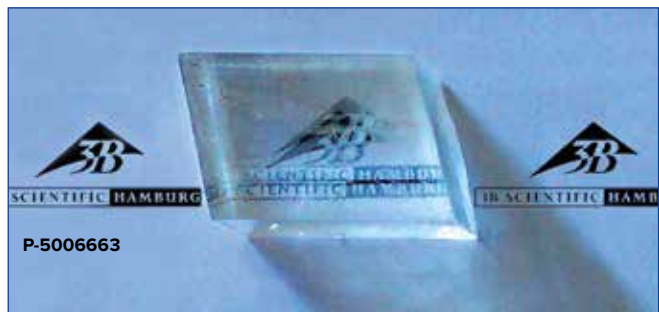

P-5006663

Doubly Refracting Crystal

Calcite crystal showing the birefringence in crystals.

P-5006663



P-1000895

Inverting Spectacles

Spectacles with two fully rotatable inverting prisms in a shielded spectacle frame. The inverting prisms reverse incoming light rays, turning the world upside down, so to speak, and making it unexpectedly difficult for the wearer to perform even the simplest of daily tasks such as reaching for objects, drawing, moving about in a room etc.

P-1000895

Amici Direct Vision Prism

A combined prism for splitting light beams into a spectrum without deflecting them. Comprises an alternating combination of two crown glass prisms and one flint glass prism; blackened on the outside.

Dispersion

angle: 4.2°

Dimensions: approx.

105x20x20 mm³

P-1002862

Additionally recommended:

P-1012863 Holder for Direct-Vision Prism on Stem



P-1002862

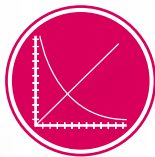

UE4040600
PDF online

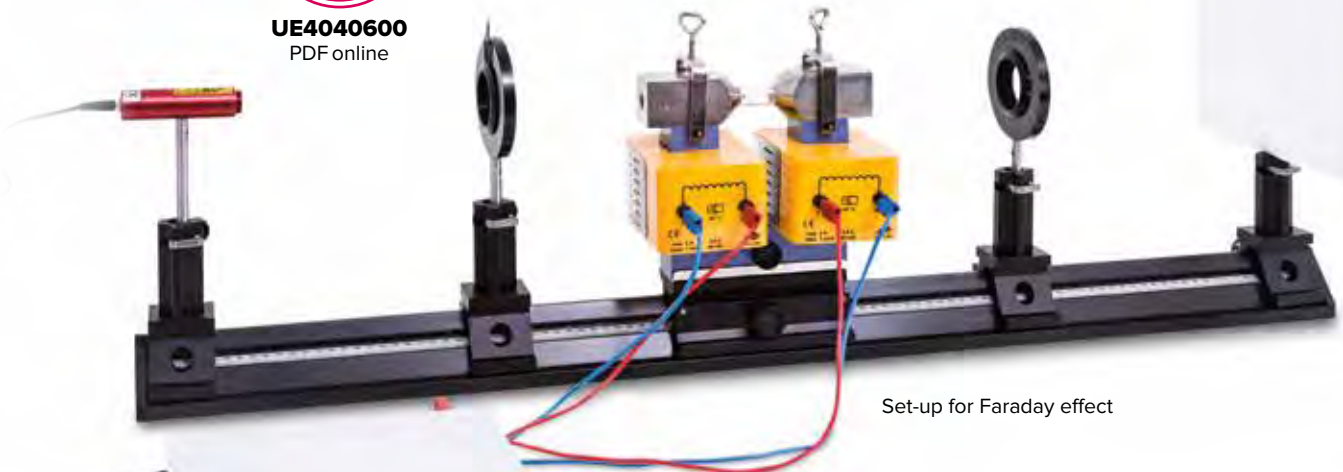

Set-up for Faraday effect



Accessories for Faraday Effect

Three-part set of accessories for holding a flint glass block (P-1012860) and a U-shaped transformer core (P-1000979) in experiments on the Faraday effect.

P-1012861

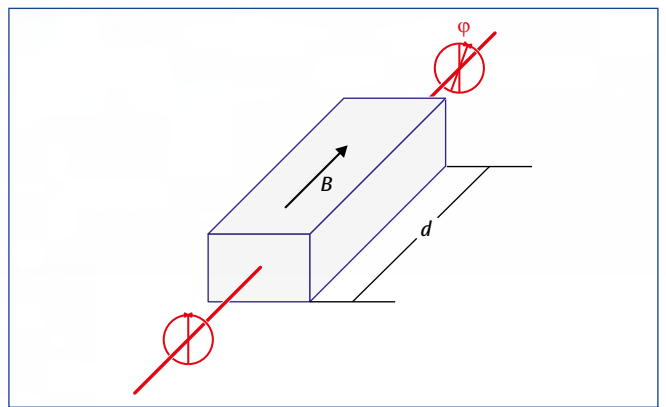

Schematic diagram to illustrate the Faraday effect



P-1012861

Equipment for Faraday Effect:

P-1002628 Optical Precision Bench D

P-1009733 Optical Base D

P-1012860 Flint Glass Block for Faraday Effect

P-1012861 Accessories for Faraday Effect

P-1000979 U Core

P-1000978 Pair of Pole Shoes

P-1000977 Pair of Clamps

P-1012859 Coil D 900 Turns (2x)

P-1012857 DC Power Supply 1 – 32 V, 0 – 20 A
(230 V, 50/60 Hz)

or

P-1012858 DC Power Supply 1 – 32 V, 0 – 20 A
(115 V, 50/60 Hz)

P-1002843 Set of 15 Safety Experiment Leads, 75 cm

P-1008668 Polarisation Filter on Stem (2x)

P-1002635 Optical Rider D, 90/50 (3x)

Light source with colour filter or laser

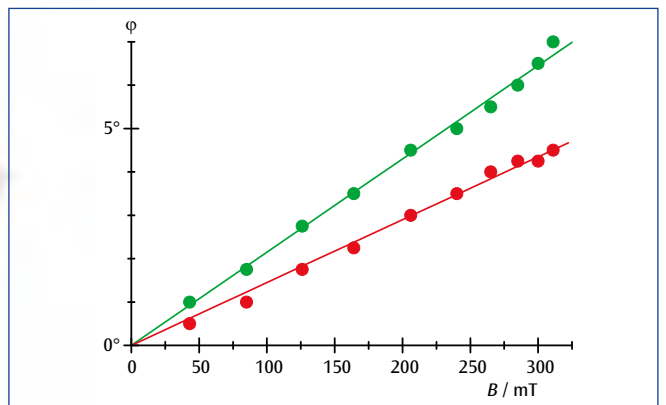

Angle of rotation as a function of the magnetic field for red and green laser light

Flint Glass Block for Faraday Effect

Rectangular block made of flint glass for demonstrating optical activity in a magnetic field (Faraday effect).

Dimensions: 20x10x10 mm³

P-1012860



P-1012860

Experiment Topics:

- Refraction and interference at the surfaces of a glass block, apertured diaphragm, square diaphragm, grating with slits, cross grating
- Michelson interferometer
- Investigation of linearly polarised light
- Absorption of light
- Reconstruction of a hologram

Equipment Set for Wave Optics with Laser

Equipment set for demonstrating fundamental phenomena in wave optics by means of practical experiments. The light source is provided by a partially polarised diode laser with adjustable mount. Power is supplied from a plug-in power supply (included) or from batteries. The components are magnetic and can be placed horizontally or vertically on the included metal board, according to the set-up required for the various experiments. All components are stored in a case with shaped foam inlay.

Diode laser: max. 1 mW, laser safety class II
 Wavelength: 635 nm
 Plug-in power supply: primary 100 V AC – 240 V AC
 secondary 3 V DC, 300 mA
 Battery holder: for 2x 1.5 V AA batteries
 (batteries not included)

Contents:

- 1 Diode laser with adjustable mounting
- 1 Plug-in power supply
- 1 Battery holder (without batteries)
- 2 Mirrors with adjustable mounting
- 1 Half-silvered mirror
- 1 Screen, white
- 1 Screen, frosted glass
- 1 Convex lens
- 1 Polarisation filter
- 1 Holder for lens and filter
- 3 Colour filters in slide frames (red, green, blue)
- 2 Apertured diaphragms in slide frames
- 2 Square diaphragms in slide frames
- 3 Gratings with slits in slide frames
- 1 Cross grating in slide frame
- 1 Glass plate in slide frame
- 1 Holder for slide frames
- 1 Hologram
- 1 Metal board (60x45 cm²) with removable strut
- 4 Rubber feet for metal board
- 1 Storage case
- 1 Experiment guide

P-1003053



P-1003053



Newton's Colour Disc, with Crank

Newton's Colour Disc for demonstrating additive combination of colours. Mounted on a stable base, moved with crank.
 Diameter of disc: 178 mm
 Dimensions of the base: 143x90x282 mm³

P-1010194



P-1010194



P-1010175

Newton's Colour Disc, with DC Motor

Newton's Colour Disc for demonstrating additive combination of colours. Mounted on a stable box, moved by a DC motor.
 Diameter of disc: 90 mm
 Motor: 4 – 6 V DC
 Connection: 4 mm safety sockets
 Dimensions: 135x85x130 mm³

P-1010175

Additionally required:
P-1002849 Pair of Safety Experiment Leads, 75 cm
P-1003560 DC Power Supply 1.5 – 15 V, 1.5 A (230 V, 50/60 Hz) or
P-1003559 DC Power Supply 1.5 – 15 V, 1.5 A (115 V, 50/60 Hz)



P-1002983

P-1002705



P-1002705

Newton's Colour Disc

Plastic, circular disc with segments coloured red, orange, yellow, light green, dark green, light blue, dark blue and violet for demonstrating additive combination of colours. When the disc is turned rapidly, its colours merge to produce white.
 Diameter: 170 mm

P-1002983

Additionally required:
P-1002705 Motor with Drive Control



P-1002983

Motor with Drive Control

Controllable motor for spinning the colour disc fast (P-1002983). With disc holder and clamp for attachment to a stand rod. Includes plug-in power supply.
 Control range: 0 – 25 rev/s
 Rotation direction: reversible
 Dimensions: approx. 110x70x45 mm³
 Weight: approx. 0.2 kg

P-1002705

Additionally recommended:
P-1002835 Tripod Stand, 150 mm
P-1002934 Stainless Steel Rod, 470 mm

Experiment topics:

- Additive colour mixing
- Subtractive colour mixing

Equipment Set for Colour Mixing

Equipment set for demonstrating how colours combine (with the aid of an overhead projector). This equipment set is designed to permit quick setting up and safe, simple operation. The clear configuration facilitates understanding of the experiments and allows direct viewing of results. The projection plate, along with its three holders for mirrors and lenses, is placed onto the projection surface of the overhead projector. Depending on the projection distance, three large circles with diameters of 30 to 80 cm appear on the projection screen. By turning



P-1003189

the holders and mirrors, it is possible to project colours so that they are separated or so that they partially overlap. Such adjustments can be performed easily and precisely. The large colour filters can be simply inserted into the lens holders, or placed directly on the overhead projector.

Contents:

- 1 Projection plate with three mirror and lens holders
- 3 Colour filters; red, green, blue (120x50 mm²)
- 3 Colour filters; cyan, yellow, magenta (120x50 mm²)

P-1003189

Additionally required:

Overhead Projector

Experiment topics:

- The three primary colours
- Creating colours by additive colour mixing
- Components of primary colours in mixed colours
- Colours on a monitor screen
- Principles of perceiving colours (colour triangle)



P-1012821

“Addition of Colours” School Apparatus

Handy desk-top device for investigating additive mixing of the primary colours, red, green and blue (RGB) to make any other colour. Three adjustment mechanisms allow any intensity of each primary colour to be selected so that various components of LED light can be mixed and observed with the help of a frosted glass screen. Includes 12 V/500 mA plug-in power supply and instruction manual for a colour triangle.

Dimensions: 192x65x120 mm³

P-1012821

Advantages

- **Plug & play: no software installation or drivers required**
- **Measurement and evaluation in real-time**
- **Simple and practical software with built-in wizards and powerful evaluation function**
- **Spectra of high quality and signal stability**
- **Low noise**
- **High resolution**
- **Suitable for measuring very slight fluctuations in intensity with very high precision**
- **Measurement of second-order diffraction without saturation of the first order**

Experiment Topics:

- Measurement and calculations for models of diffraction at a single slit, multiple slit and diffraction gratings.
- Interference
- Fluctuations in intensity

CCD HD Sensor

Optical sensor for investigating distribution of light intensity. Particularly well suited for the investigation of light diffraction at single slits, multiple slits or diffraction gratings. User-friendly measurement and evaluation software enable simultaneous recording and analysis in real-time. The built-in software for Windows 2000/XP/Vista/7/8 32- and 64-bit versions starts running as soon as the sensor is connected to the computer via a USB cable. Includes attenuating filter, stand rod and plug-in power supply.

Software:

Data acquisition possible in two modes:
 Intensity as a function of location, e.g. for diffraction and interference.
 Intensity in a region as a function of time.
 Pointer mode, model calculation mode, spreadsheet and report modes are all available for the purposes of evaluation.

Sensor: Toshiba 3648 pixel SWB
 Resolution: 16 bits
 Integration time: 0.1 ms to 6.5 s
 Filter attachment: Clix (magnetic ring)
 Sensitive surface of sensor: 8 µm x 30 mm
 Interface: USB 2.0

P-1018820

Additionally recommended:

- P-1003201 Laser Diode, Red**
- P-1003203 Component Holder**
- P-1008664 Diffraction Apertures on Glass Plate**
- P-1008665 Slits and Bars on Glass Plate**
- P-1003204 Double Slits on Glass Plate**
- P-1008666 Multiple Slits on Glass Plate**
- P-1002628 Optical bench**
- P-1002635 Optical rider (3x)**



P-1018820



P-1003201

Experiment Topics:

- Pockels effect (linear electro-optic effect)
- Photorefractive crystal with no inversion centre
- Occurrence and modification of double refraction in external electric fields
- Half-wave voltage
- Modulation of refractive index

new

Pockels Cell on Stem

Transverse Pockels cell for demonstrating linear electro-optic effect and measuring half-wave voltage of a lithium niobate crystal. With accurate, free-moving and smooth angle adjustment for demonstrating double refraction in conjunction with a polarisation filter used as an analyser.

Dimensions: 156x26x218 mm³
 Weight: 206 g
 Crystal: Lithium niobate (LiNbO₃), 20x2x2 mm
 Connectors: 4-mm safety sockets

P-1013393

Additionally recommended:

- P-1002628 Optical Precision Bench D P-1000 mm
- P-1002635 Optical Rider D, 90/50 (3 x)
- P-1012401 Optical Rider D, 90/36 (2x)
- P-1008668 Polarisation Filter on Stem
- P-1000608 Projection Screen
- P-1003165 He-Ne Laser
- P-1005408 Achromatic Objective 10x / 0.25
- P-1003022 Convex Lens on Stem f =+50 mm
- P-1013412 High Voltage Power Supply E 5 kV (230 V, 50/60 Hz) or
- P-1017725 High Voltage Power Supply E 5 kV (115 V, 50/60 Hz)
- P-1002849 Pair of Safety Experiment Leads, 75 cm

Pockels effect

Light and Optics

Advantage

- With accurate, free-moving and smooth angle adjustment



P-1013393

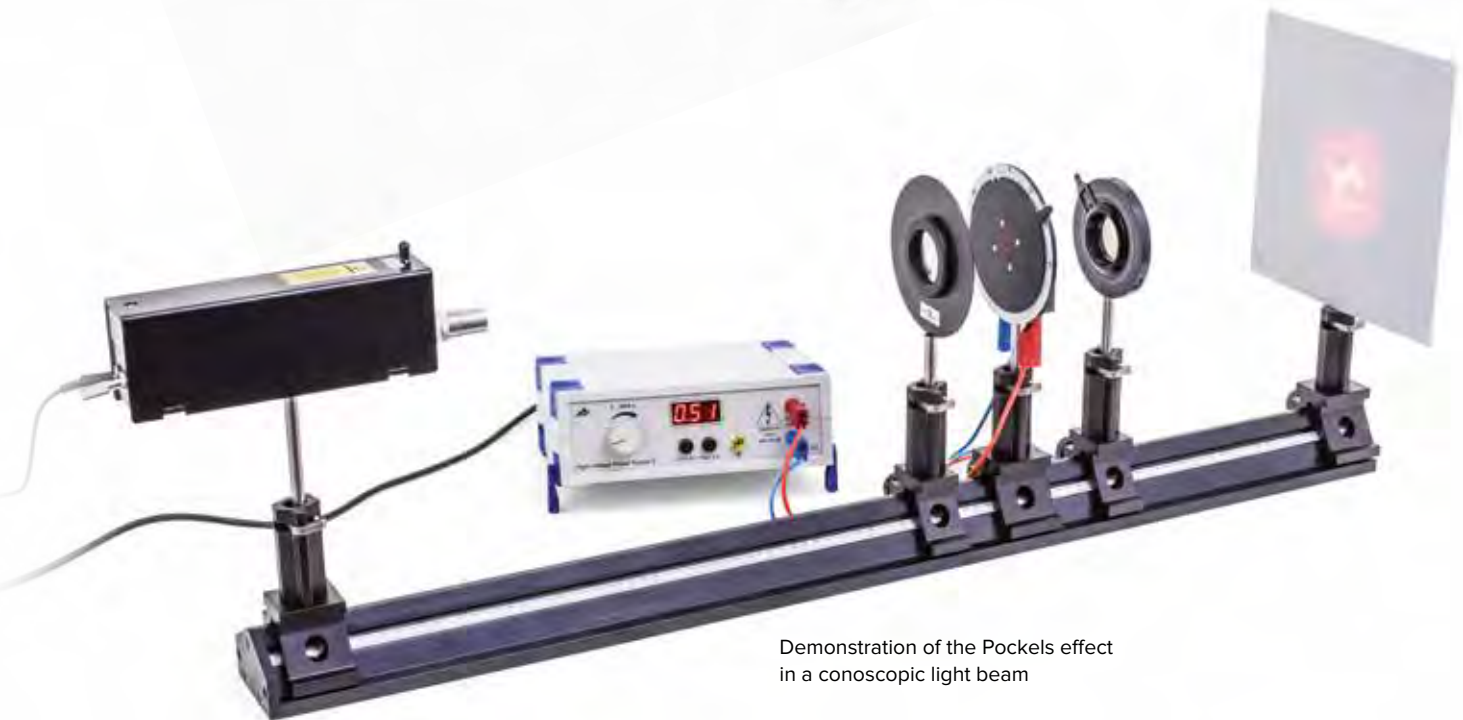

Demonstration of the Pockels effect in a conoscopic light beam



P-1002906

Demonstration Polarimeter

Device for use on an overhead projector to demonstrate optical activity and determine specific angles of rotation and concentrations at known specific angles of rotation. A yellow filter (for more precise measurement accuracy) and a polariser are embedded in a black plastic base plate. A cell containing a solution of the substance to be investigated with 50 mm and 100 mm markings is inserted into the holder. The analyzer is situated above this set-up in a holder with rotary handle and pointer. By turning the analyser, it is possible to ascertain the angle of rotation and read it off a transparent angle scale.

Cuvette: Markings at 50 mm and 100 mm
 Angle scale: -40° – $+40^\circ$
 Scale divisions: 1°
 Dimensions: approx. 370x330x190 mm³

P-1002906

Additionally required:
Overhead Projector

Demonstration Polariscopes

Apparatus for use on an overhead projector to demonstrate a photo-elastic image in samples subjected to stress and strain. The polarising filter is incorporated into the base plate of the frame; the analyser is embedded in the laterally swivelling upper base plate. Via the spindle drive, a tensile or pressure load can be exerted on the test body.

Samples: Epoxy-resin
 Dimensions: approx. 150x150x45 mm³
 Total weight: approx. 820 g

Contents:

- 1 Basic apparatus
- 2 Metal clamps for applying tension
- 1 Ring, 60 mm diam.
- 1 Block, 60x10x10 mm³
- 2 Blocks, 20x10x8 mm³
- 3 Triangles to lay on surface

P-1000851

Additionally required:
Overhead Projector



P-1000851

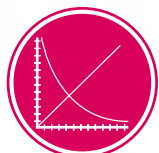
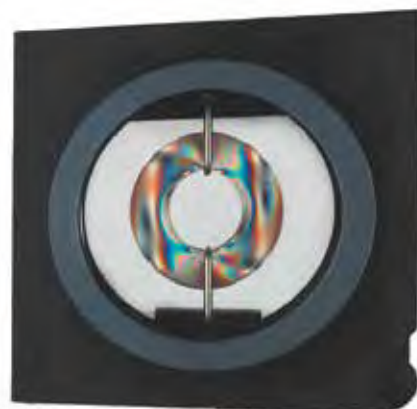

UE4040300
 PDF online



P-1001057

Polarimeter with 4 LEDs

Polarimeter with a lighting unit comprising four monochromatic LEDs for determining the angle and direction of rotation of polarised light as a function of wavelength as well as sample thickness and concentration with the help of an optically active substance. The light emerging from those LEDs that are lit is polarised linearly and transmitted through a fitted sample cylinder filled with the optically active substance. The analyser in the cover is used to identify the direction of polarisation which can be read on the cover's angle scale.

Wavelength of LEDs: 468 nm (blue), 525 nm (green),
 580 nm (yellow), 630 nm (red)
 Dimensions: approx. 110x190x320 mm³
 Weight: approx. 1 kg

P-1001057

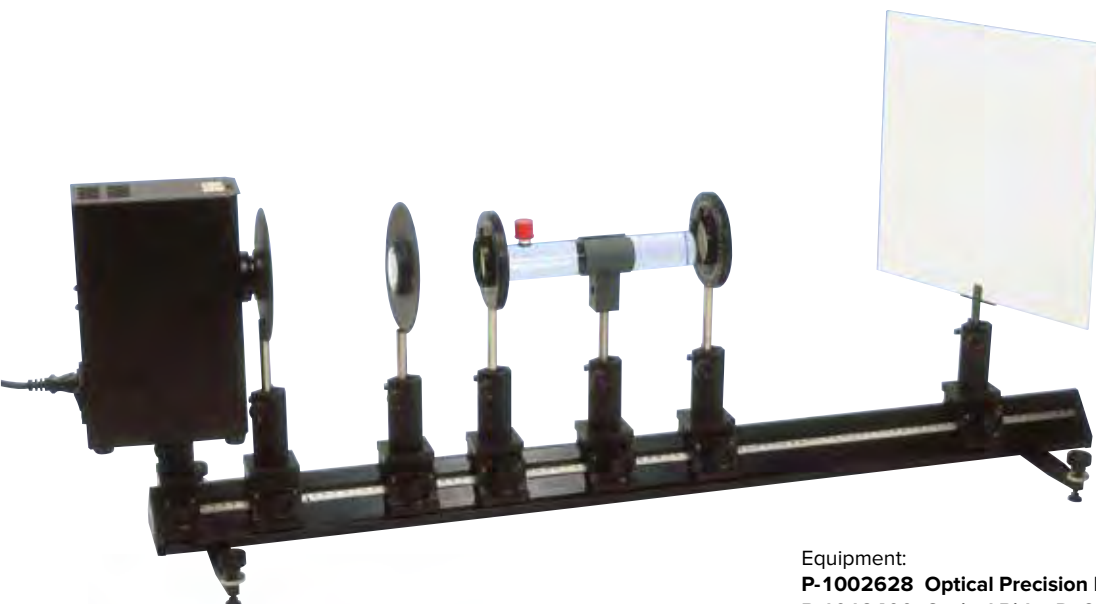

Determination of the angle of rotation of optically active substances

Equipment:

- P-1002628** Optical Precision Bench D, 1000 mm
- P-1012400** Optical Rider D, 60/50 (2x)
- P-1002635** Optical Rider D, 90/50 (5x)
- P-1002721** Cell Holder on Stem
- P-1002884** Round Cell, 200 mm
- P-1002885** Round Cell, 100 mm
- P-1003017** Iris Diaphragm on Stem
- P-1003022** Convex Lens on Stem, $f = 50$ mm
- P-1000608** Projection Screen
- P-1008668** Polarisation Filter on Stem (2x)
- P-1003159** Na Low-Pressure Spectral Lamp (230 V, 50/60 Hz)



P-1002721



P-1002884

P-1002885

Round Cells

Duran glass cells with bonded optical discs and GL threads. E.g. for experiments on the determination of the angle of rotation of optically active substances on the optical bench.

Diameter: 35 mm
Thread: GL-14

Round Cell, 100 mm

P-1002884

Round Cell, 200 mm

P-1002885

Cell Holder on Stem

Plastic holder for round cells (P-1002884) and (P-1002885).

Holder: 36 mm diam.
Stem: 90 mm x 10 mm diam.

P-1002721

Polarimeter

Polarimeter with a sodium lamp as the light source for the measurement of the rotation and the rotation direction of the polarisation plane of polarised light through optically active substances as well as the determination of the concentration of liquids. Robust metal stand with slightly tilted shaft for tubes with lengths up to 220 mm. With swivel cover, analyser and polariser. A sodium lamp with filter holder is used as a light source. Includes polarimeter tubes 100 mm, 200 mm and spare sodium lamp.

Measurement range: 2 semi-circles (0 – 180°)
Glass tubes: 100 and 200 mm, 15 mm diam.
Scale division: 1°
Readability: 0.05° (with Vernier scale)
Dimensions: 200x360x450 mm³
Weight: approx. 10 kg
Light source: Sodium lamp (589 nm)
Mains voltage: 115 V – 230 V, 50/60 Hz

P-1008696

Spare Sodium Lamp (not shown)

Spare lamp for polarimeter (P-1008696).

P-1012885

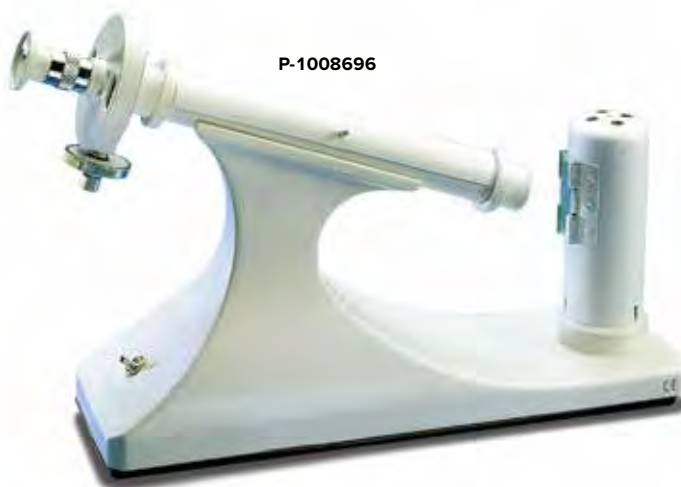

P-1008696

Polarimeter Tube 100 mm

(not shown)
Spare glass tube for polarimeter (P-1008696).
Length: 100 mm, 15 mm diam.

P-1012883

Polarimeter Tube 200 mm

(not shown)
Spare glass tube for polarimeter (P-1008696).
Length: 200 mm, 15 mm diam.

P-1012884

Control Unit for Spectrum Lamps

Control unit for operating spectral lamps (P-1003537 – P-1003546), including a lamp housing on a stand rod. A second lamp housing on a stand rod can be clamped to the rear side of the stable metal housing and connected to the electricity supply. A switch on the front can be used to change over between the right-hand and left-hand spectral lamps.

Maximum output current: 1 A

Lamp housing: 180 mm x 50 mm diam.
 Tripod rod: 300 mm x 10 mm diam.
 Lamp socket: Pico 9
 Dimensions: approx. 255x175x135 mm³
 Weight: approx. 5.3 kg

Contents:

1 Control unit
 1 Lamp housing on a stand rod with a 7-pole connection cable

Control Unit for Spectrum Lamps (230 V, 50/60 Hz)

P-1003196

Control Unit for Spectrum Lamps (115 V, 50/60 Hz)

P-1003195

Additionally recommended:

P-1003197 Lamp Housing on a Stand Rod

Lamp Housing on a Stand Rod (not shown)

Additional lamp housing with a cable for connecting to a spectral lamp ballast coil (P-1003196 resp. P-1003195).

P-1003197

Spectrum Tube Power Supply

Control unit for stable operation of spectral tubes (P-1003402 – P-1003417). The integrated current limiter ensures a long service life of the tubes. Spring-contacts in fully insulated fixtures and a protective window guarantee secure mounting and reliable operation.

Voltage: 5000 V
 Maximum current: 10 mA
 Dimensions: approx. 370x120x90 mm³

Spectrum Tube Power Supply (230 V, 50/60 Hz)

P-1000684

Spectrum Tube Power Supply (115 V, 50/60 Hz)

P-1000683

Spectrum Tubes

High luminance spectral tubes emitting the line or band spectrum of a gas or mercury vapour. Partly evacuated capillary glass tubes filled with gas or mercury vapour are furnished with electrodes for the application of a voltage to generate the electrical field that provides the necessary energy.

Capillary length: 100 mm
 Total length: approx. 260 mm

Spectral Lamps

Gas discharge lamps for emitting line spectra of inert gases and metal vapours with high luminance and spectral purity.

Socket: Pico 9
 Operating current: max. 1A
 Weight: approx. 350 g

Spectral lamps may only be operated with the control unit for spectral lamps (P-1003196 or P-1003195).

Additionally required:

P-1003196 Control Unit for Spectrum Lamps (230 V, 50/60 Hz) or

P-1003195 Control Unit for Spectrum Lamps (115 V, 50/60 Hz)



P-1003537 / P-1003546

Art. No.	Filling
P-1003537	Cd
P-1003539	He
P-1003541	Na
P-1003543	Ne
P-1003544	Tl
P-1003545	Hg 100
P-1003546	Hg/Cd

P-1003196 / P-1003195

UE5020150
PDF online

P-1000684 / P-1000683

Additionally required:

P-1000684 Spectrum Tube Power Supply (230 V, 50/60 Hz) or

P-1000683 Spectrum Tube Power Supply (115 V, 50/60 Hz)

Art. No.	Filling
P-1003402	Air
P-1003403	Argon
P-1003404	Bromine
P-1003405	Carbon dioxide
P-1003406	Chlorine
P-1003407	Deuterium
P-1003408	Helium
P-1003409	Hydrogen
P-1003410	Iodine
P-1003411	Krypton
P-1003412	Mercury
P-1003413	Neon
P-1003414	Nitrogen
P-1003415	Oxygen
P-1003416	Water vapor
P-1003417	Xenon

Recording the line spectrum of hydrogen



P-1000684

UE5020100
PDF online

P-1018103

High-Pressure Mercury Spectral Lamp (230 V, 50/60 Hz)

Gas discharge lamp for observing high-intensity mercury spectral lines at high vapour pressures. Lines in the ultra-violet range are suppressed by the glass body. Includes a black metal housing with integrated power supply unit, a light aperture with a fine thread for direct screw-mounting of filters and a threaded stand rod.

Luminance: 1800 lm
 Operating current: 0.6 A
 Power: 50 W
 Base: E27
 Service life: approx. 24000 h
 Threaded light aperture: 40 mm diam.
 Fine thread for filter: M49
 Dimensions: approx. 295x165x85 mm³
 Weight: approx. 1.5 kg

P-1003157

Low-Pressure Mercury Spectral Lamp (230 V, 50/60 Hz)

Gas discharge lamp for observing mercury spectral lines at low vapour pressures with optimal line widths. The body is made of quartz glass to allow detection of lines in the ultra-violet range too. Includes a black metal housing with integrated power supply unit, a light aperture with a fine thread for direct screw-mounting of filters and a threaded stand rod.

Operating current: 0.16 A
 Power: 6 W
 Base: G5
 Service life: approx. 3000 h
 Threaded light aperture: 40 mm diam.
 Fine thread for filter: M49
 Dimensions: approx. 295x165x85 mm³
 Weight: approx. 1.5 kg

P-1003158

Low-Pressure Sodium Spectral Lamp (230 V, 50/60 Hz)

Gas discharge lamp for observing Na D lines and investigating of the doublet. Includes a black metal housing with integrated power supply unit, a light aperture with a fine thread for direct screw-mounting of filters and a threaded stand rod.

Luminance: 1800 lm
 Operating current: 0.35 A
 Power: 18 W
 Base: BY22d
 Service life: approx. 10000 h
 Threaded light aperture: 40 mm diam.
 Fine thread for filter: M49
 Dimensions: approx. 295x165x85 mm³
 Weight: approx. 1.5 kg

P-1003159

Spare Lamps: (not shown)

Art. No.	Description
P-1003161	Hg High-Pressure Spectral Lamp for P-1003157
P-1003162	Hg Low-Pressure Spectral Lamp for P-1003158
P-1003163	Na Low-Pressure Spectral Lamp for P-1003159



P-1003158

P-1003157

P-1003159

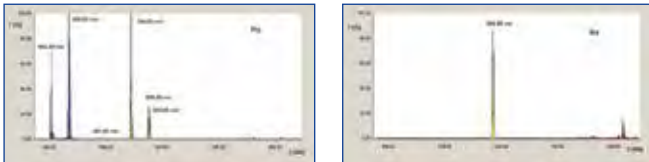

Line spectra of Hg (high-pressure) and Na, recorded using the digital spectrometer

High-Pressure Mercury Vapour Lamp

High-pressure mercury vapour lamp in hardened glass bulb made of blackened borosilicate glass, with tube-shaped hole allowing emission of unfiltered ultra-violet radiation. Includes E27 lamp holder on stem and see-through screen to protect users from UV radiation.

Wavelength ranges: UV-A, UV-B, UV-C
 Power consumption: 125 W

P-1000852

Additionally required:

P-1003196 Control Unit for Spectrum Lamps (230 V, 50/60 Hz)

or

P-1003195 Control Unit for Spectrum Lamps (115 V, 50/60 Hz)

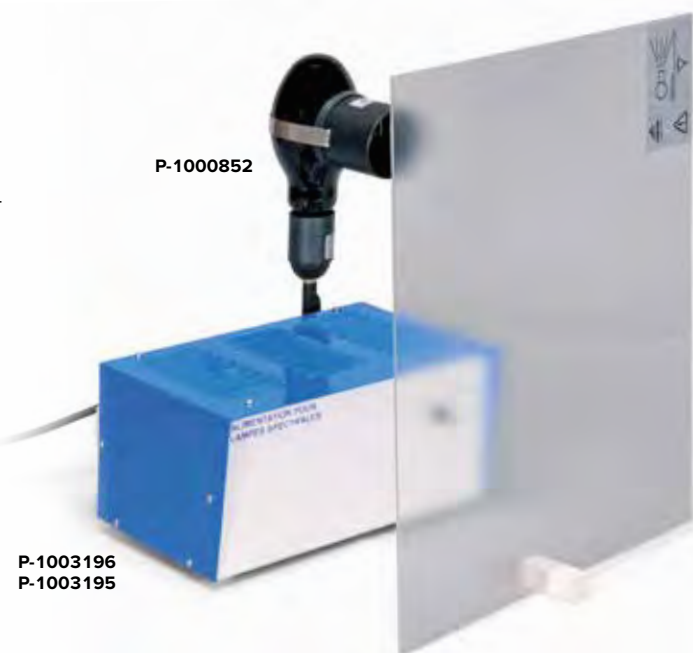

P-1000852

**P-1003196
P-1003195**

Handheld Spectroscope

Device for observing absorption and emission spectra, e.g. to observe the Fraunhofer line spectrum in sunlight for the observation of absorption spectra through liquids, the emission spectra of gas discharge tubes or for chemical analysis during flame tests.

Spectroscope in Cardboard Box

Hand spectroscope in a flat cardboard box with printed wavelength scale for easy reading of spectral lines and spectra.

Dimensions: approx. 180x115x25 mm³

P-1003183

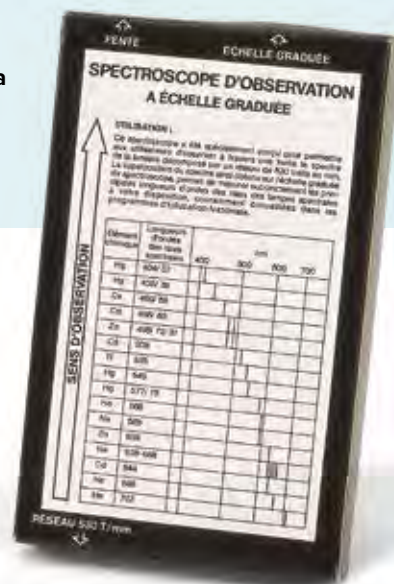

P-1003183

Spectroscope in Metal Case

Hand spectroscope in a flat metal case with printed wavelength scale for easy reading of spectral lines and spectra. With holder for mounting a probe in a plastic vessel.

Dimensions: approx. 180x115x25 mm³

P-1003184



P-1003078

Pocket Spectroscope

High quality optical system with centered visible spectrum, which is linear with respect to the wavelength. In metal sleeve. With fixed slit and prism system with grating

Slit width: 0.2 mm

Number of grating lines: 600 lines/mm

Dimensions: approx. 115 mm x 25 mm diam.

Weight: approx. 62 g

P-1003078



P-1003184

Hand Spectroscope with an Amici Prism

Precise optical system with a visible spectrum that is linear in terms of wavelength around the centre point. In a metal housing with an adjustable slit and high-grade Amici prism. Delivery in hinged case for protective and dust-free storage.

Angular dispersion: 7° (C-F)

Linear dispersion: 60 mm

Slit width: 0 – 1 mm

Folding case: approx. 150x70x30 mm³

Weight: approx. 150 g

P-1003531



P-1003531

Spectrometer-Goniometer

Spectrometer with rotatable prism and directionally-adjustable objective tube for observing and measuring emission and absorption spectra. Can also be used for precise determination of the optical parameters of prisms. Includes prism with mounting and a holder for transmission gratings.

- Objective tube: Symmetrical precision slit of hardened steel; adjustable slit width, slit height and distance; $f = 160$ mm, 18 mm diam.
- Eye-piece tube: Continuous focusing and viewing angle adjustment, eyepiece with cross-wire, $f = 160$ mm, 18 mm diam.
- Prism: flint glass (60°)
 - Dispersion ($n_F - n_C$): 0.017
 - Base length: 33 mm
 - Height: 22 mm
- Angular scale: 0° to 360°
 - Scale divisions: 0.5°
 - Reading precision: $1'$ (Vernier scale with magnifying lens)
- Height: 250 mm approx.
- Weight: 8 kg approx.



P-1002912

P-1002912



P-1002911

Kirchhoff-Bunsen Spectroscopy

Desktop spectroscopy for the observation and measurement of emission and absorption spectra. With adjustable slit, condenser, flint glass prism as well as an observation telescope with sliding ocular. Scale tube with reference division, which is superimposed on the image plane of the spectrum due to reflection at the front surface of the prism. Includes removable prism hood. Ideal for schools and universities.

- Observation tube: moveable, with locking screw, slideable eyepiece
- Objective: $f = 160$ mm, 18 mm diam.
- Slit tube: stationary, with symmetrical slit
- Objective: $f = 160$ mm, 18 mm diam.
- Scale tube: stationary, 200-division scale
- Eye-piece: $f = 90$ mm, 18 mm diam.
- Scale: can be calibrated in wavelengths
- Prism: Flint glass (60°), Dispersion ($n_F - n_C$): 0.017
- Length of base: 20 mm, height: 30 mm
- Weight: 4.8 kg

P-1002911

S-system Spectrometer-Goniometer

Spectrometer with rotatable prism or grating and directionally-adjustable objective tube for observing and measuring emission and absorption spectra. Can also be used for precise determination of the optical parameters of prisms or gratings. Includes prism with holder and transmission grating with holder.

- Objective tube: Adjustable slit width and object distance; $f = 175$ mm, 32 mm diam.
- Eye-piece tube: Continuous focusing and viewing angle adjustment, eyepiece with cross-wire, $f = 175$ mm, 32 mm diam.
- Prism: flint glass (60°)
 - Dispersion ($n_F - n_C$): 0.017
 - Base length: 40 mm
 - Height: 40 mm
- Transmission grating: 300 lines/mm
- Angular scale: 0° to 360°
 - Scale divisions: 0.5°
 - Reading precision: $0.5'$ (Vernier scale)
- Height: 250 mm
- Weight: approx. 12 kg



P-1008673

P-1008673

Advantages

- **Plug & play: no software installation or drivers required**
- **Connect up your spectrometer and the spectrum is obtained immediately**
- **Measurement and evaluation in real-time**
- **Simple and practical software with built-in wizards and powerful evaluation functions**
- **Internal memory for measured data**
- **Spectra of high quality and signal stability**
- **Highly stable metal casing with built-in entry slit**
- **Internal beam paths and the principle of operation can be viewed by opening the lid of the casing**

Digital Spectrometer

Digital spectrometer for quantitative analysis of emission and absorption spectra, for recording transmission curves and performing measurements in calorimetry and kinetics. Incident light from a fibre-optic cable is dispersed into a spectrum by a Czerny-Turner monochromator and projected from there onto a CCD detector. The entry slit is built into the casing. User-friendly measurement and evaluation software enable simultaneous recording and analysis in real-time. The built-in software for Windows 2000/XP/Vista/7/8 32- and 64-bit versions starts running as soon as the sensor is connected to the computer via a USB cable. Includes plug-in power supply and holder for fibre-optic cable.

CCD detector:	3600 pixels
Resolution:	16 bit
Integration time:	0.1 to 60 s
Entry slit:	40 μm metal
Interface:	USB 2.0
Connectors:	SMA 905
Fibre-optic cable:	2 m
Mains voltage:	100 – 240 V
Dimensions:	133x120x60 mm ³
Weight:	950 g

Digital Spectrometer HD

Grating:	1200 lines/mm
Spectral range:	400 – 700 nm
Spectral resolution:	0.5 nm (for resolution of sodium doublet)
Accuracy:	1 pixel per 0.08 nm

P-1018104

Experiment Topics:

- Line spectra, continuous spectra
- Black-body radiators, Wien's law
- Emission spectrum of sodium
- Flame spectra
- Transmission spectra of solid bodies and liquids
- Kinetics
- Beer-Lambert law

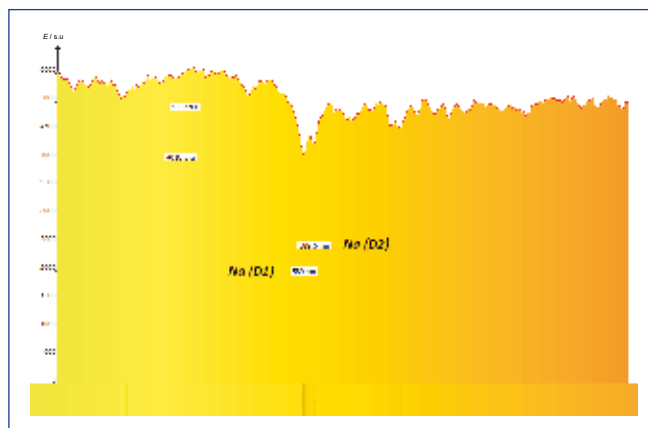

Sodium absorption lines in the spectrum of the sun (resolution of sodium doublet), observed using digital spectrometer HD.

Digital Spectrometer LD

Grating:	600 lines/mm
Spectral range:	350 – 900 nm
Spectral resolution:	1 nm (for resolution of mercury doublet)
Accuracy:	1 pixel per 0.15 nm

P-1018103

Digital Spectrometer LD with Absorption Chamber (p. 181)

P-1019196

Additionally recommended:

P-1018106 Set of 100 Cuvette Cells, 4 ml

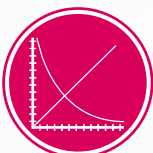

UE5020100
UE5020150
PDF online

Digital Spectrometer LD with Absorption Chamber

Multi-functional module for recording transmission or absorption measurements using 4-ml cells (10x10x40 mm), objects in slide format (50x50 mm) or objects in coin format (40 mm diam.). Up to two slide-format objects and one coin-format object can be analysed simultaneously and compared. With built-in light source for the spectral region from 350 – 1000 nm. In metal casing resistant to chemicals. For direct connection to digital spectrometers LD via fibre-optic cable.

Light source: 350 – 1000 nm
 Power supply: 12 V (via adaptor cable from plug-in power supply for digital spectrometer)
 Dimensions: 65x100x55 mm³
 Weight: 250 g

P-1019196

Additionally recommended:

P-1018106 Set of 100 Cuvette Cells, 4 ml

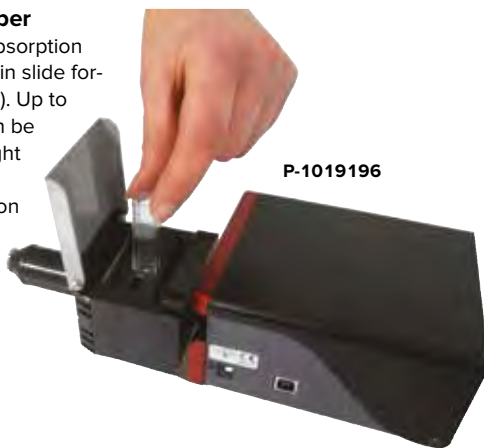

Set of 100 Cuvette Cells, 4 ml (not shown)

Set of 100 disposable cuvette cells for use in absorption chamber for digital spectrometers LD (P-1019196).
 Dimensions: 10x10x40 mm³

P-1018106



UE4020400
 PDF online

Recording the transmission spectra of colour filters.



Spectrophotometer S

Robust spectrometer for investigating the near infra-red and infra-red regions of the spectrum between 360 and 800 nm. Its removable covers allow students to see first hand the spectrum analysis process. Setup is quick and easy. The optical signal enters the device through a flexible fibre optic cable. Connection to a PC is via the USB 2.0 interface. A specially selected transmission grating and precision slit gives high resolution and excellent results. Data collection software is intuitive with real time graphical output. For easier interpretation of the spectrum, each wave band is shaded with the corresponding colour. The spectrum can be viewed either as a graph or in text form, which allows for more advanced calculations. The availability of several toolbars makes it possible to set the spectrometer parameters to exactly fit the requirements of the experiment. Spectrometer S is supplied ready to use; tested and calibrated.

Spectral range: 360 – 800 nm
 Spectrometer resolution: < 2.0 nm
 Pixel resolution: < 0.5 nm
 Operating system: Win XP, Vista, Win7
 Interface: USB 2.0
 Dimensions: 60x60x120 mm³
 Weight: 600 g

Contents:

Spectrophotometer S with USB cable, fibre optic cable, and a CD containing experimental software and an instruction manual. Laptop not included.

P-1003061



Experiment topics:

- Mach-Zehnder interferometer
- Changes in polarisation at beam splitter and mirror surface
- Demonstration analogous with quantum eraser experiment
- Determination of the refractive index of glass*
- Determination of the refractive index of air*
- Twyman-Green test for optical components (qualitative)*

* Accessory set (P-1002652) required



P-1014617



UE4030520
PDF online

Mach-Zehnder Interferometer

Complete equipment set consisting of two beam splitters, two surface-coated mirrors, two observation screens and four polarisation filters. The high-grade optical components mounted on a heavy, rigid base plate for precise and reproducible measurements. Beyond the first beam splitter, the two parts of the split beam take different paths to the second beam splitter, where they are once again superimposed. This means that by adding in polarisation filters, it is possible for the two beams to be differently polarised. The large optical components permit a generation of clear and well-defined interference patterns, which can even be viewed in daylight as the tilt of the two reflecting observation screens can be adjusted. Pre-defined component positions allow quick rearrangement to ensure extremely rapid preparation for the various experiments. The equipment set includes a stable plastic box for storing the mounted and adjusted interferometer as well as the base plate for laser.

Beam splitter:

Diameter: 40 mm
Evenness: $\lambda/10$ (front side), $\lambda/4$ (rear side)

Surface-coated mirror:

Dimensions 40x40 mm²
Evenness: $<\lambda/2$

Polarisation filter:

Diameter: 30 mm
Adjustable range: $\pm 105^\circ$
Material: Glass (2x), foil (2x)
Angular graduation: $3^\circ, 15^\circ$

Base plate:

Weight: 5.5 kg
Dimensions: 245x330x25 mm³

P-1014617

Additionally required:

P-1003165 He-Ne-Laser

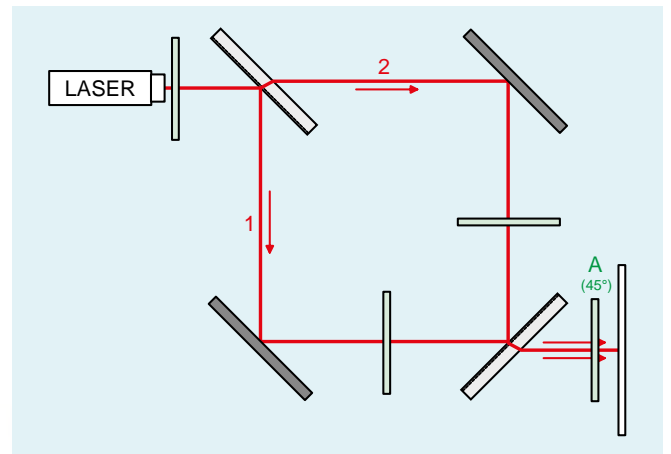

Paths through the Mach-Zehnder interferometer (polariser A "erases" the path information)



P-1017284

Optical Lamp with Pinhole Aperture

High quality source of white light with a pinhole aperture fitting which can be rotated and latches into position. Includes matching base for use with Mach-Zehnder or Michelson interferometers.

Light source: LED, 2x2 mm² light-emitting surface
Light intensity: 289 lumen
Pinholes: 0.5/0.7/1.0/1.4/2.0/2.8/4.0/5.7/8.0/16 mm

P-1017284

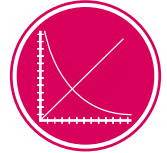

UE4030410
PDF online

Experiment topics:

- Michelson Interferometer
- Fabry-Perot Interferometer
- Determination of the refractive index of glass*
- Determination of the refractive index of air*
- Twyman-Green test for optical components (qualitative)*

* Accessory set (P-1002652) required



P-1002651



Interferometers

Interferometer

This complete equipment set comprises high grade optical components mounted on a heavy, rigid base plate for precise and reproducible measurements. The large optical components permit a generation of clear and well defined interference patterns in daylight. The reflective observation screen has an adjustable inclination. Pre-defined component positions allow quick rearrangement to ensure extremely rapid preparation for the various experiments. The equipment set includes a stable plastic box for storing the mounted and adjusted interferometer as well as the base plate for laser.

Beam splitter:

Diameter: 40 mm
Evenness: $\lambda/10$ (front side), $\lambda/4$ (rear side)

Surface-coated mirror:

Dimensions 40x40 mm²
Evenness: $<\lambda/2$

Accessory Set for the Interferometer

This accessory set for the interferometer (P-1002651) consists of a vacuum cell for determining the refractive index of air and a glass plate on a rotatable holder for determining the refractive index of glass and investigating the surface quality of optical components (Twyman-Green interferometer).

P-1002652

Additionally required:
P-1012856 Vacuum Hand Pump
P-1002622 Silicone Tube

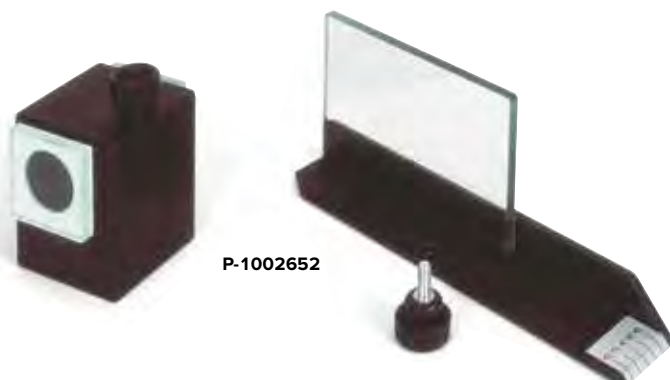

P-1002652

Mirror adjustment:

Eccentric reduction: approx. 1:1000 (individual calibration specified on eccentric base)

Base plate:

Weight: 5.5 kg
Dimensions: 245x330x25 mm³

P-1002651

Additionally required:
P-1003165 He-Ne Laser



Glass plate in the beam path of the Michelson interferometer



Vacuum chamber in the beam path of the Michelson interferometer

Light and Optics

Advantages

- Precise, safe and inexpensive solution for the operation of continuous wave (cw) and pulsed diode lasers.
- Precise current-controlled continuous wave and pulse-type laser driver
- Two TEC (Thermo Electric Cooler) drivers with PID controllers
- Digital and analogue modulation inputs

- Multiple safety circuits
- Stored configuration (EEPROM)
- Very low power dissipation due to bias voltage control in cw-mode
- Digital control using isolated RS232 serial interface

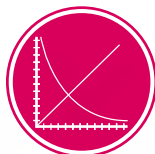
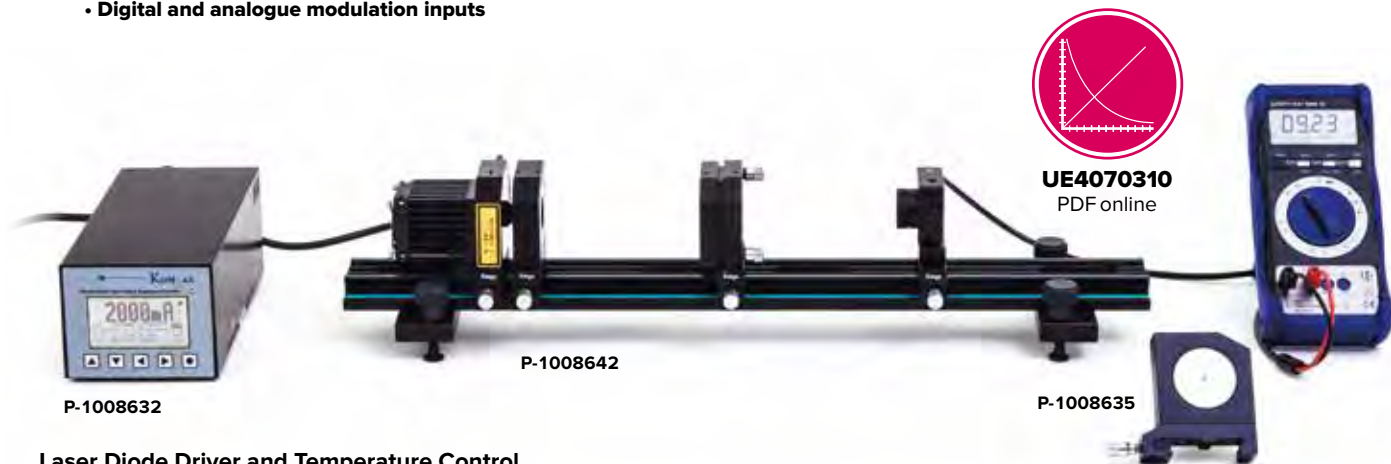

UE4070310
PDF online

Laser Diode Driver and Temperature Control

Power supply for current-stabilised control of laser diode using control unit to control the power of the optical beam from the laser diode in cw mode by means of the built-in photodiode input. In pulsed mode the laser diode can be operated with the freely configurable built-in oscillator or externally using the modulation input. The temperature controllers are designed as PID controllers and configured for standard operation with NTC and Pt100 sensors. The use of silicon temperature sensors or other types is equally possible simply by altering the software configuration.

P-1008632

Laser:

Laser current range:	0 – 2500 mA
Laser current resolution:	1 mA
Laser current accuracy:	<1 mA
Laser current noise:	<60 μ s
Pulse rise time:	<10 μ s
Pulse fall time:	<5 μ s
Voltage range:	1.2 – 5 V
Current limit:	adjustable between 0 – 2500 mA
External digital modulation input:	TTL

TEC Driver:

Peltier current:	max. -4 – +4 A
Peltier current (2nd driver):	max. -2 – +2 A
Peltier voltage:	max. 8 V
Peltier current limit:	adjustable between 0 – 4 A
Peltier current limit (2nd driver):	adjustable between 0 – 2 A
Peltier current resolution:	1 mA
Temperature control accuracy:	<10 mK

General specs:

Over-temperature protection:	for driver and laser
Mains voltage:	100 up to 240 V AC
Dimensions:	88x110x240 mm ³

Optical Bench KL

Profile rail with levelling platform, 600 mm.

P-1008642

Nd:YAG-Module

Module with Nd:YAG crystal to act as an active laser medium with dielectrically coated surface for reflecting the laser wavelength (1064 nm) during simultaneous transmission of the pumping wavelength (808 nm). On rider for optical bench KL.

P-1008635



P-1002866

Laser Safety Goggles for Nd:YAG Laser

Nylon goggles for average protection levels, integral construction for reduced weight with enlarged visual field due to large filter lenses. Supplied in a storage pouch.

Filter colour:	light blue
Degree of light transmission:	$T_{D65} = 62\%$
Specification according to DIN EN 207/208:	750 – 1100 D L5 + IR L7 > 1100 – 1200 DIR L5

P-1002866

Infra-Red Detector Card (not shown)

Converter card for converting infra-red light into visible light. Held directly in a laser to act as a sensor.

Dimensions:	90x60 mm ²
-------------	-----------------------

P-1017879

Safety instructions:

The system described here is a class four laser. The laser light emitted is not visible to the naked eye but is nevertheless highly hazardous for eyes and also dangerous for skin. It can also cause fires or explosions.

- Observe safety regulations for class 4 lasers
- Always wear goggles which can protect you from laser beams
- Even with protective goggles, do not look straight into the laser beam.

Diode Laser 1000 mW

1000 mW diode laser for optical pumping of Nd:YAG laser. With built-in Peltier cooler and thermistor plus collimating and focussing lens. On rider for optical bench KL.
Emission wavelength: 808 nm

P-1009497

Alignment Laser Diode

Tunable laser diode, on rider for optical bench KL.
Wavelength: 633 nm
Power: 1 mW

P-1008634

Frequency Doubling Module

Module with KTP crystal (potassium titanyl phosphate) for use as a non-linear optical element for frequency doubling, featuring built-in Peltier cooler and thermistor. In rotating holder on rider for optical bench KL.

P-1008636

Cr:YAG-Module

Module with Cr:YAG crystal for passive Q-switch circuit. On rider for optical bench KL.

P-1008637

Laser Mirror

Mirror for laser light of wavelength 1064 nm with spherical curvature. Includes adjustment mounting, on rider for optical bench KL.
Radius of curvature: -200 mm
Reflection coefficient: 97%

P-1008638

Laser Mirror HAT, 532 nm (not shown)

Mirror for laser light with spherical curvature for decoupling frequency-doubled laser beams of wavelength 532 nm. Includes adjustment mounting, on rider for optical bench KL.
Radius of curvature: -200 mm

P-1008639

PIN Photodiode DET 36 A/M

PIN photodiode in casing with thread for accommodating filters. On rider for optical bench KL.
Rise time/fall time: <14 ns
Wavelength range: 350 – 1100 nm
Detector surface: 13 mm²
Battery: E23, 12 V

P-1008640

PIN Photodiode DET 10 A/M (not shown)

PIN photodiode in casing with thread for accommodating filters. On rider for optical bench KL.
Rise time/fall time: <1 ns
Wavelength range: 200 – 1100 nm
Detector surface: 0.8 mm²
Battery: E23, 12 V

P-1008641

Collimator Lens, f = +75 mm

Collimator lens, f = +75 mm, with anti-reflective coating on both sides. On rider for optical bench KL.

P-1008646

Filter RG850 (not shown)

RG850 filter for suppressing pumping radiation. In holder with screw thread.

P-1008648

Filter BG40 (not shown)

BG40 filter for suppressing fundamental wavelength. In holder with screw thread.

P-1017874

Transport Case KL (not shown)

Padded transport case for all solid body laser components.

P-1008651



P-1009497



P-1008636



P-1008638



P-1008637



P-1008646



P-1008634



P-1008640

Experiment: “Tuning of Diode Laser for Stable Optical Pumping”

- Measurement of output power of diode laser as a function of applied current.
- Determination of how wavelength depends on temperature.
- Determination of how wavelength depends on injection current.
- Determination of injection current-temperature curve at constant wavelength (maximum absorption).

Number / Description	Art. No.
1 Laser Diode Driver and Temperature Controller	P-1008632
1 Diode Laser 1000 mW	P-1009497
1 Nd:YAG Module	P-1008635
1 Alignment Laser Diode	P-1008634
1 PIN Photodiode DET 36 A/M	P-1008640
2 Collimator Lens, f = +75 mm	P-1008646
1 Filter RG850	P-1008648
1 Optical Bench KL	P-1008642
1 Transport Case KL	P-1008651
1 Laser Safety Goggles for Nd:YAG Laser	P-1002866
1 Infra-Red Detector Card	P-1017879

Experiment: “Set-Up and Optimisation of Nd:YAG Laser”

- Tuning of diode laser for stable optical pumping of Nd:YAG laser.
- Determination of lifetime of the upper laser level ${}^4F_{3/2}$ in an Nd:YAG crystal.
- Adjustment of resonator and observation of resonator modes.
- Measurement of output power of Nd:YAG laser as a function of pumping power and determination of laser threshold.
- Observation of spiking in pulsed operation of laser diode.

Number / Description	Art. No.
1 Laser Diode Driver and Temperature Controller	P-1008632
1 Diode Laser 1000 mW	P-1009497
1 Nd:YAG Module	P-1008635
1 Alignment Laser Diode	P-1008634
1 Laser Mirror	P-1008638
1 PIN Photodiode DET 36 A/M	P-1008640
1 Filter RG850	P-1008648
1 Optical Bench KL	P-1008642
1 Transport Case KL	P-1008651
1 Laser Safety Goggles for Nd:YAG Laser	P-1002866
1 Infra-Red Detector Card	P-1017879
1 Digital Multimeter P3340	P-1002785
1 Digital Oscilloscope 4x60 MHz	P-1008676
1 HF Patch Cord, BNC/4 mm Plug	P-1002748
1 HF Patch Cord	P-1002746

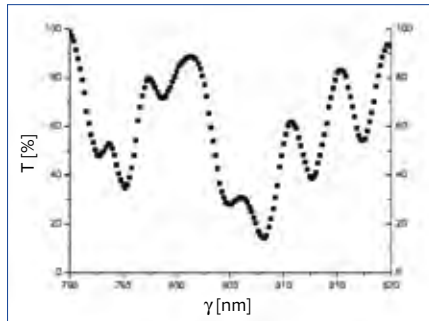

Transmission spectrum of an Nd:YAG crystal as a function of wavelength, recorded using a spectrometer

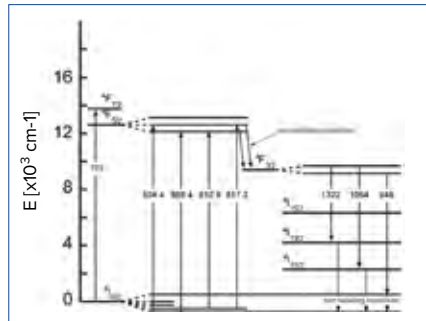

Energy level diagram for an Nd:YAG crystal with the most important transitions for optical pumping and laser operation

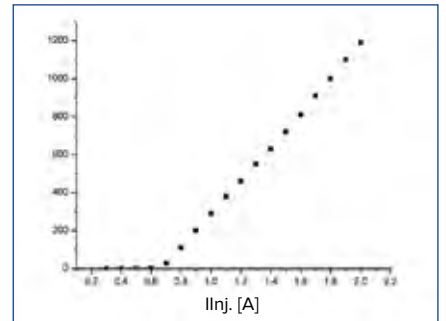

Output power of diode laser at 20° C as a function of the injection current

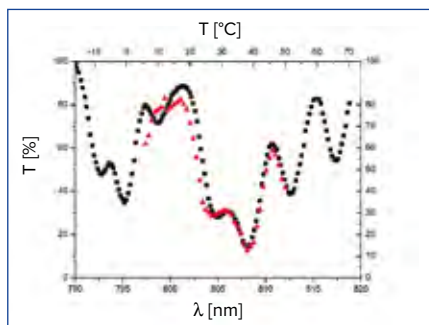

Comparison of transmission functions: Square– $T(\lambda)$ recorded using a spectrometer
Triangular – Transmission as a function of temperature

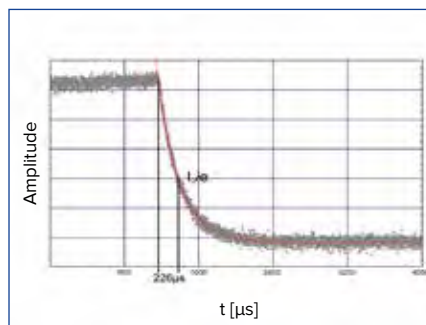

Measurement of half-life for the ${}^4F_{3/2}$ level in an Nd:YAG crystal.
An exponential function has been fitted to the measurements

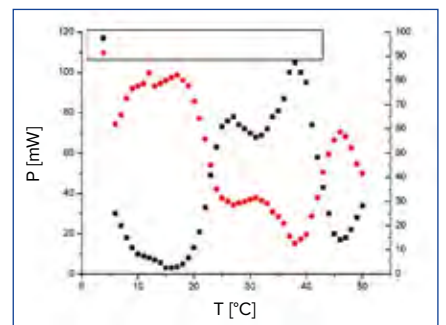

Transmission of light from a diode through an Nd:YAG crystal as a function of temperature for various injection currents

Experiment: "Q-Switch Circuit for Nd:YAG Laser with Cr:YAG Module"

- Set-up and optimisation of Q-switch circuit
- Recording of pulses and determination of pulse duration.



UE4070320
PDF online

Experiment: "Frequency Doubling with an Nd:YAG Laser"

- Frequency doubling within the resonator using a KTP crystal
- Measurement of output power of frequency-doubled beam as a function of power of fundamental wave.
- Investigation of dependency on crystal orientation and temperature.

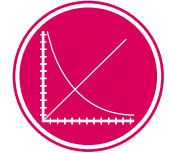

UE4070330
PDF online

Number / Description	Art. No.
1 Laser Diode Driver and Temperature Controller	P-1008632
1 Diode Laser 1000 mW	P-1009497
1 Nd:YAG Module	P-1008635
1 Alignment Laser Diode	P-1008634
1 Cr:YAG Module	P-1008637
1 Laser Mirror	P-1008638
1 PIN-Fotodiode DET 10 A/M	P-1008641
1 Filter RG850	P-1008648
1 Optical Bench KL	P-1008642
1 Transport Case KL	P-1008651
1 Laser Safety Goggles for Nd:YAG Laser	P-1002866
1 Infra-Red Detector Card	P-1017879
1 Digital Multimeter P3340	P-1002785
1 Digital Oscilloscope 4x60 MHz	P-1008676
1 HF Patch Cord, BNC/4 mm Plug	P-1002748
1 HF Patch Cord	P-1002746

Number / Description	Art. No.
1 Laser Diode Driver and Temperature Controller	P-1008632
1 Diode Laser 1000 mW	P-1009497
1 Nd:YAG Module	P-1008635
1 Alignment Laser Diode	P-1008634
1 Frequency Doubling Module	P-1008636
1 Laser Mirror HAT, 532 nm	P-1008639
1 PIN Photodiode DET 36 A/M	P-1008640
1 Filter BG40	P-1017874
1 Filter RG850	P-1008648
1 Optical Bench KL	P-1008642
1 Transport Case KL	P-1008651
1 Laser Safety Goggles for Nd:YAG Laser	P-1002866
1 Infra-Red Detector Card	P-1017879
1 Digital Multimeter P3340	P-1002785
1 HF Patch Cord, BNC/4 mm Plug	P-1002748

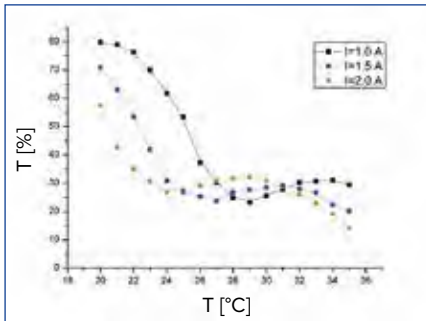

Comparison of curve characteristics for transmission of light through an Nd:YAG crystal and output power of the Nd:YAG laser as a function of the diode temperature

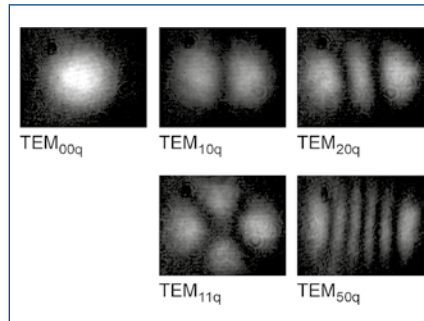

Transverse modes

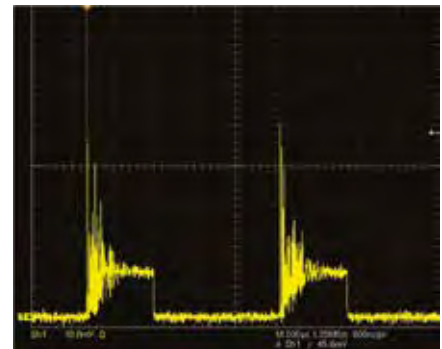

Oscilloscope trace: spiking in a Nd:YAG laser

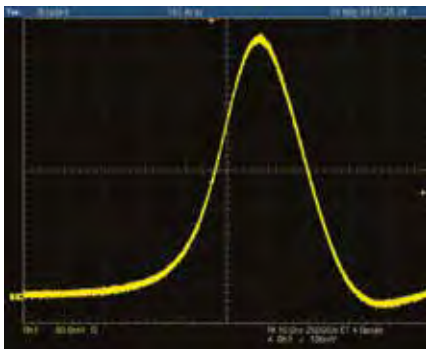

Oscilloscope trace: trace of pulses from a passive Q-switched Nd:YAG laser. Pulse duration 25 ns

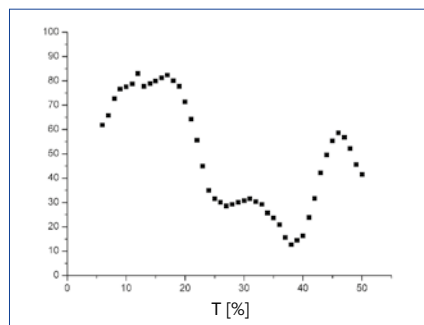

Transmission of light from a diode through an Nd:YAG crystal as a function of temperature at an injection current of 1.5 A

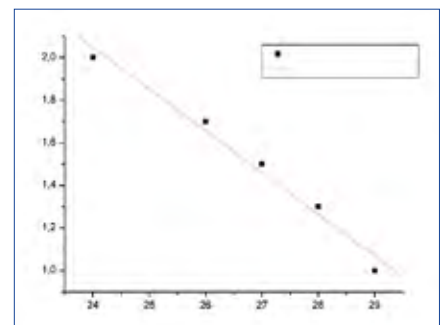

Current-temperature graph at constant wavelength

Experiment topics:

- Glass fibres and optical telecommunications
- Acceptance cone and optimisation of coupling to a fibre optic cable
- Absorption, effect of the length of the transmission line
- Coupling losses
- Diffraction by an optical grating and optical multiplexing.
- Dichroitic filters and optical demultiplexing
- Spectral composition of light sources
- Spectral dispersion and recombination
- Colour and interference filters
- Signal shaping and matching
- Band width and limiting frequency
- Calculation of theoretical band width
- Optical diaphony

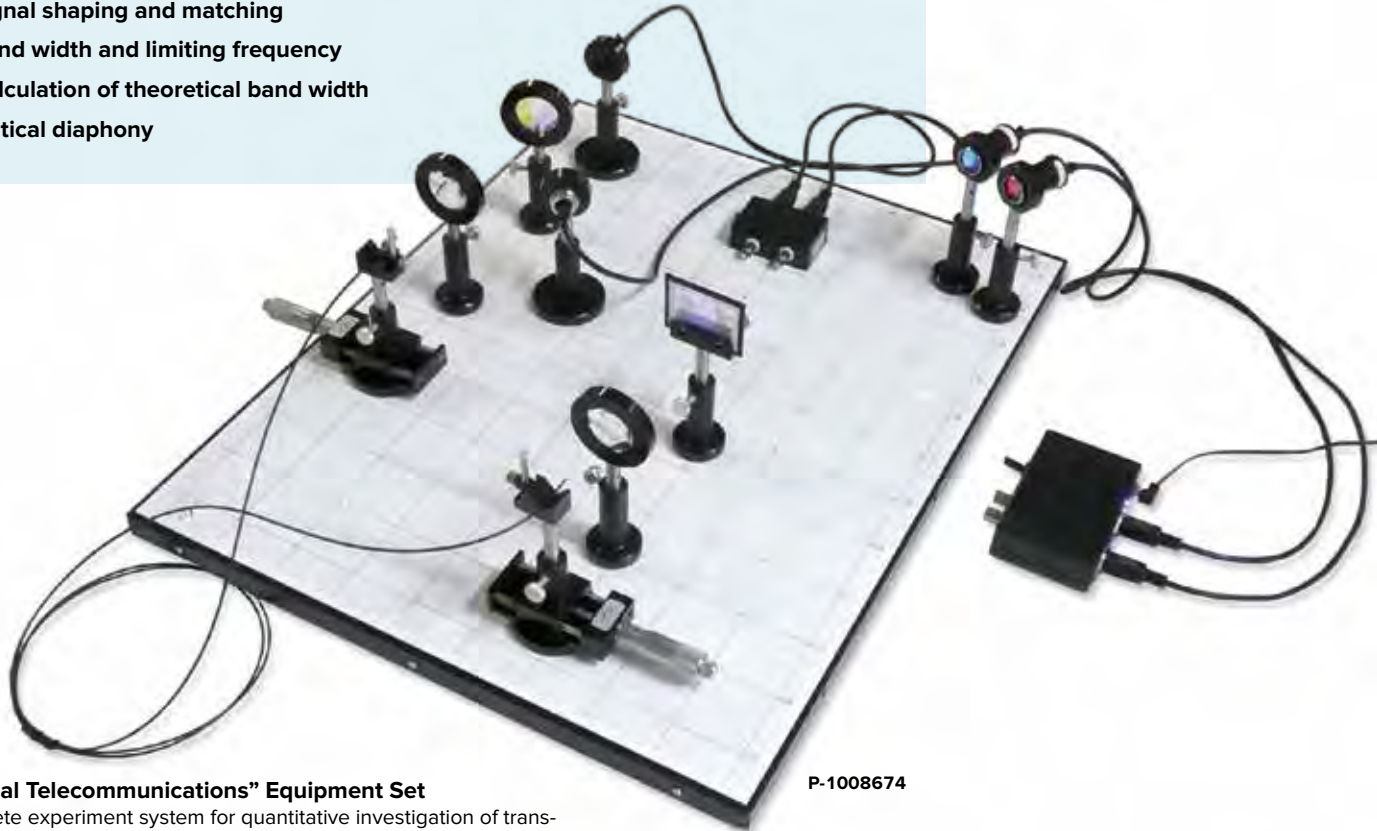
**“Optical Telecommunications” Equipment Set**

Complete experiment system for quantitative investigation of transmission of signals via optical media, plus the processes of optical multiplexing and demultiplexing. To build a two-dimensional optical system of high precision, a magnetic bench with a printed grid is provided, upon which it is possible to write.

Optical bench:

Available surface: 600x480 mm²
 Grid radials: 0°, 45°, 90°, 135°
 Grid subdivisions: 5 cm, 1 cm
 Weight: 12 kg approx.

Contents:

- 1 Optical bench, 600x480 mm, for attachment of magnetic components
- 8 Optical riders with magnetic base
- 2 Movable riders, l = 25 mm, with magnetic base
- 1 LED with collimating lens, in frame on stem, red
- 1 LED with collimating lens, in frame on stem, blue
- 1 Electronic signal transmitter, including power supply
- 1 Electronic signal receiver, including power supply
- 2 Phototransistors in housing on stem
- 1 Fibre-optic cable with SMA plugs, 1 m
- 1 Diffraction grating, 600 lines/mm
- 1 Dichroitic filter in housing on stem, blue
- 1 Dichroitic filter in housing on stem, yellow
- 2 Converging lenses in housing on stem, f = 50 mm, 40 mm diam.
- 1 Slide holder for gratings, on stem
- Component holders and spring clips

P-1008674

P-1008674

Additionally recommended:

- P-1008675 “Spectrometry” Supplementary Set**
- P-1008677 Two-Channel Function Generator, 20 MHz**
- P-1008676 Digital Oscilloscope 4x60 MHz**
- P-1002746 HF Patch Cord (6x)**
- P-1002752 T-Piece, BNC (2x)**

“Spectrometry” Supplementary Set (not shown)

Supplement to the “Optical telecommunications” equipment set for investigating spectrometry of transmitted signals and measurement of absorption losses.

Contents:

- 1 Spectrometer with SMA connectors
- 1 Reference light source with SMA connectors
- 5 Fibre optic cables with SMA plugs, 2 m
- 1 Fibre optic cable with SMA plugs, 10 m
- 5 SMA/SMA connectors

P-1008675

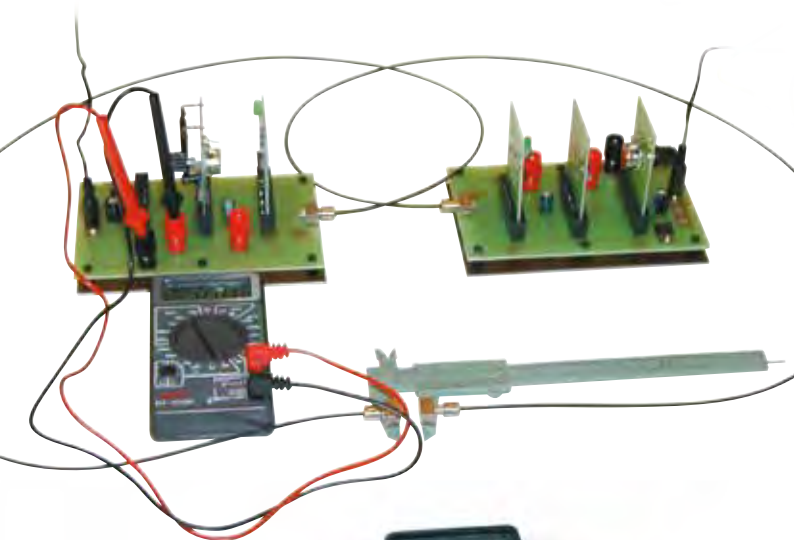

Experiment Topics:

- Tyndall's light guide experiment
- Attenuation in curved optical waveguides
- Attenuation in liquids
- Attenuation at optical transitions
- Setup for force measurement
- Setup of light barrier
- Setup for proximity sensor
- Transmission of audio signals
- Data transmission between two computers



P-1003054

Equipment Set for Waveguide Optics

Complete modular experiment set for examining optical waveguide phenomena and their applications. Consisting of one base PCB for use as a transmitting and receiving module, one analogue transmitting and receiving unit, one digital transmitting and receiving unit, one microphone amplifier and low-frequency generator, one low-frequency amplifier with integrated loudspeaker, USB interface for transmitter and receiver, one digital multimeter, sheathed and unsheathed optical fibres of different lengths and all connecting cables. Including universal plug-in power supplies and storage case.

Wall power supply units: 100 – 240 V AC (primary)
9 V DC (secondary)

P-1003054

Additionally recommended:

P-1002727 Analogue Oscilloscope

P-1002748 High-Frequency Patch Cord, BNC / 4-mm Plug

Equipment Set for Laser Communication

Experiment system for transmitting audio and video signals with a laser beam. Consisting of power supply for laser diode with variable output power and with audio and video input for modulation of laser beam, receiver unit with integrated amplifier and connectors (CINCH) for loudspeakers and TV set, microphone and loudspeaker. Audio signals are frequency modulated and video signals amplitude modulated. For transmitting video signals, any PAL or NTSC video camera (refer to p. 292) can be connected (not included in scope of delivery). Including universal plug-in power supplies and storage case.

Laser diode: Laser protection class II
Wavelength: 635 nm
Laser power: 0.2 – 1mW continuously variable
Plug-in power supply: 100 – 240 V AC 50/60 Hz (primary),
12 V DC (secondary)

P-1003055



P-1003055



Light Speed Meter

Equipment set for determining the speed of light thanks to electronic run-time measurement. Comprises a compact housing containing a transmitter emitting short LED pulses, a photo receiver and a calibrated, oscillating quartz generator producing chronologically precise square-wave pulses. Emitted light pulses are returned by an internal reflector and by a triple-prism reflector placed a long distance from the light source. The returning light signals are then superimposed on the original signal. A dual-channel oscilloscope is used to measure the time difference between the two signals. The speed of light can be calculated from this difference and the distance to the triple-prism reflector. The triple-prism reflector can be installed by eye without the need for complex adjustments

Contents:

- 1 Control unit with a transmitter, receiver and integrated power supply unit
- 1 Fresnel lense on shaft
- 1 Triple-prism reflector on shaft
- 3 HF cables, 1 m

Light Speed Meter (230 V, 50/60 Hz)

P-1000882

Light Speed Meter (115 V, 50/60 Hz)

P-1000881

Additionally required:

- P-1018583 Digital Oscilloscope, 2 x100 MHz**
- Optical Bench**
- Optical Rider (2x)**
- Stand Equipment**



**P-1000882
P-1000881**



UE4060100
PDF online

Funhouse Mirror

The Funhouse Mirror is a high grade polyester sheet with vacuum deposited silver metal surface. The mirror is 0.8 mm thick; it will not tear but can be cut with normal scissors. Keep out of sunlight as it can focus light and heat to start fires. Comes rolled into 4 cm tube, will unroll flat. This is a great way to teach concave and convex mirrors and real and virtual images. Many applications, use your imagination! For attachment to wall with double-sided adhesive tape.

Funhouse Mirror 135x210 cm²

P-1003338

Funhouse Mirror 60x130 cm²

P-1003339

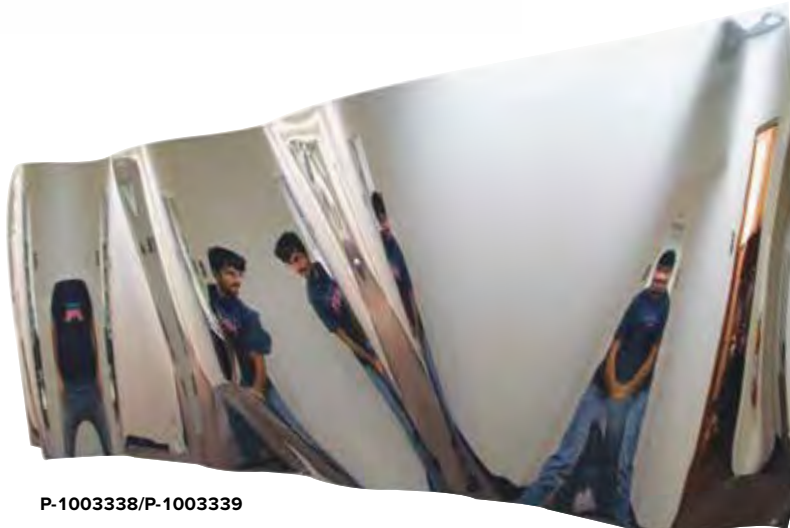

P-1003338/P-1003339

Experiment Topics:

- Adaptation (accommodation) of the eye's lens
- Short-sightedness
- Long-sightedness
- Presbyopia
- Correction by means of spectacles



P-1005047

Functional Model of the Eye

Model for demonstrating the functions of the human eye, including inverted display of images on the retina. The curvature of the silicone lens can be changed by means of water pressure in order to demonstrate the process of accommodation. A holder serves to position corrective glass lenses in front of the eye's lens. The set is mounted on a wooden base and includes an optical object, glass lenses (-0.5 D, +1.0 D) and English operating instructions.

Dimensions: approx. 320x180 mm²
Weight: approx. 1.5 kg

P-1005047

6-Piece Model of a Human Eye

Model of a human eye enlarged to 3 to 1 scale. Features sclera (white of the eye) and cornea plus muscle attachments, which can be separated into two halves, plus choroid with retina and iris, which is also separable into two, as well as a lens and a glass body. Mounted on base.

Dimensions: 90x90x150 mm³ approx.
Weight: 100 g approx.

P-1000259



P-1000259

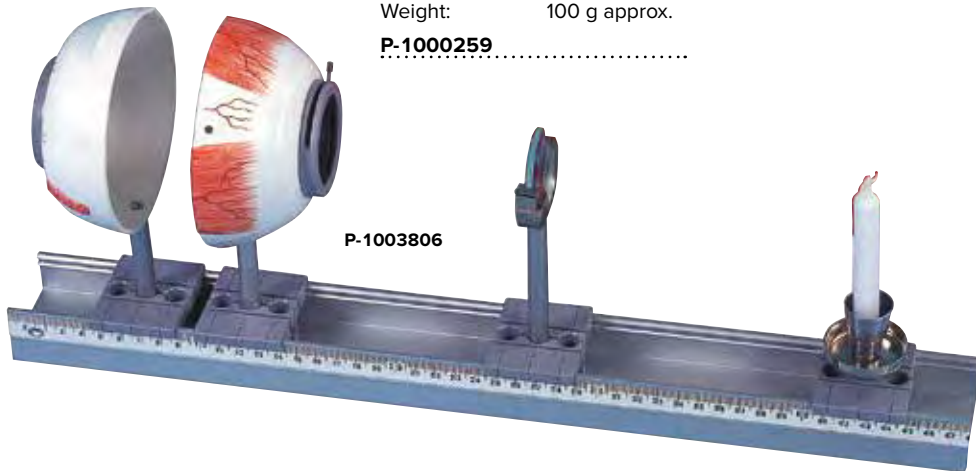

P-1003806

Physical Eye Model

This model can be used to demonstrate the optical functions of the eye, e.g. representation of an object on the retina, accommodation (change in the lens curvature), short sightedness and far sightedness. The model comprises:

- Half eyeball with adjustable iris diaphragm, lens holder and 2 convex lenses ($f = 65$ mm and 80 mm), on a rod
- Half eyeball with retina (transparent screen), on a rod
- Lens holder with one concave and one convex corrective lens, on a rod
- Candle holder with 2 candles, on a rod
- Aluminium rail, 50 cm long, with 4 clamp slides
- Storage case

49x5.5x18 cm; 2.0 kg

P-1003806



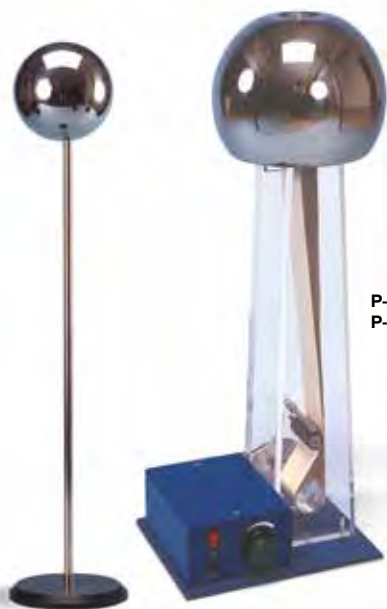

P-1002964
P-1002963

Van de Graaff Generator

Generator for the generation of DC potentials with low current for multiple experiments in electrostatics. Detachable conductor sphere, drive motor with controllable speed, including small discharge sphere on rod.

Voltage: up to approx. 100 kV
Length of sparks: up to 5 cm
Conductor sphere: 190 mm diam.
Sphere on rod: 460 mm, diam. 90 mm
Dimensions: approx. 240x190x620 mm³

Van de Graaff Generator (230 V, 50/60 Hz)

P-1002964

Van de Graaff Generator (115 V, 50/60 Hz)

P-1002963

Electrostatic Equipment Set

Using this equipment many historical experiments can be performed to investigate electrostatic phenomena. The components are equipped with 4 mm connector pins thus providing for rapid and easy interchangeability of assembly on an insulated stand. Connection chains are included for connection to the charge source, but experiment cables with 4 mm plugs can also be used. We recommend that the Wimshurst machine (P-1002967) be used as a charge source in these experiments.

Contents:

- 1 Standbase
- 1 Stand rod, insulated, with retaining and connection socket
- 1 Conductor sphere 30 mm diam., with pin
- 1 Rolling sphere race
- 1 Elder-pith double pendulum with hook stand
- 10 Pieces of elder-pith (in box)
- 1 Box with spherical electrode
- 1 Box with pointed electrode
- 1 Triskelion wheel on needle bearing
- 1 Bundle of tissue paper strips on rod
- 1 Luminous pane
- 1 Chimes with bells
- 1 Friction rod, plastic, with 4 mm socket
- 2 Connection chains
- 1 Experiment instructions

P-1000924

Additionally required:

P-1002967 Wimshurst Machine

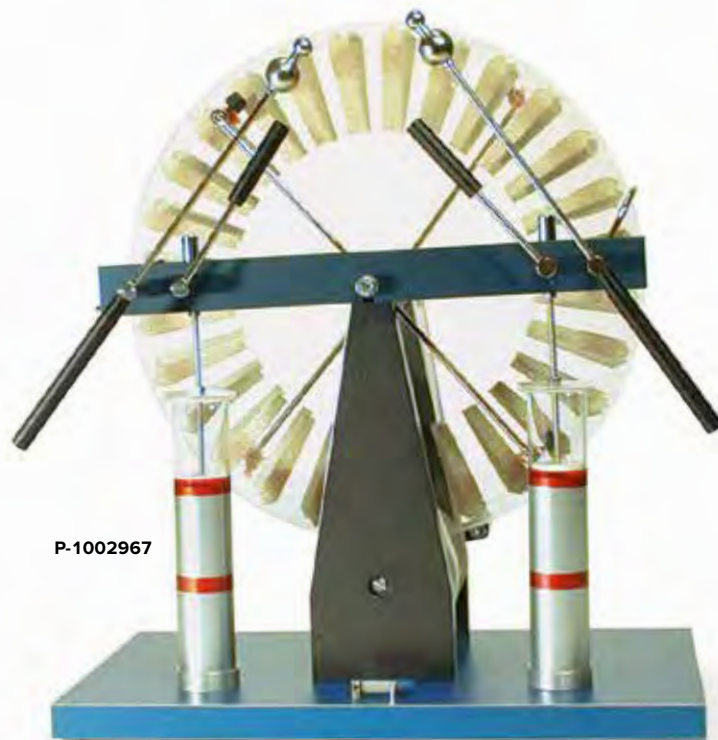

P-1002967

Wimshurst Machine

Historical experiment set-up for the generation of safe, high DC potentials for numerous experiments in the area of electrostatics. Hand crank operation and belt drive, adjustable spark gap, two high-voltage capacitors (Leyden jars).

Diameter: 310 mm
Spark gap: max. 120 mm
Dimensions: approx. 360x250x400 mm³
Weight: approx. 3.4 kg

P-1002967

Rubber Belt for Van de Graaff Generator (not shown)

Spare rubber belt for Van de Graaff generator (P-1002964 or P-1002963).

Length: 930 mm
Width: 50 mm

P-1002965



P-1000924



P-1003048

Electroscope

Pointer instrument for the detection of electrical charges and voltages. Shielding ring with 4 mm earthing sleeve. Suitable for shadow projection. Includes sphere, capacitor plate on 4 mm plug and capacitor plate on insulating rod.
Diameter: approx. 130 mm

P-1003048

P-1001027



Kolbe's Electroscope

Pointer instrument for the detection of electrical charges and voltages with high sensitivity. Metal housing with 4 mm earthing sleeve, glass front and rear, needle with pivot bearing, scale, suitable for shadow projection. Includes capacitor plate on 4 mm plug.
Measuring range: 0 – 6 kV
Dimensions: approx. 170x110x190 mm³

P-1001027



P-1000923

Piezoelectric Charge Source

Hand-held unit used for the simple generation of safe voltages needed in electrostatic experiments. Featuring the functional principle of a piezoelectric gas lighter. With shortened earthing sleeve and 4 mm cable plug. The colour may deviate from the colour in the image.
Voltage: ±4.5 kV
Dimensions: approx. 250x25x33 mm³
Weight: approx. 130 g

P-1000923

Electroscope S

Inexpensive instrument with dial for demonstrating electrical charge and voltage potential. Designed in the form of a stand base, frame, aluminium rod with magnet holder and electroscope unit.
Dimensions: 280x80x280 mm³ approx.
Weight: 500 g approx.

P-1009964



P-1009964



P-1009962

Charge Indicator

Display instrument for showing electric charge and its sign, whereby either a blue or a red LED lights up in the presence of charge. Includes two 1.5-V batteries (AA).
Dimensions: 62x67x20 mm³ approx.
Weight: 85 g approx.

P-1009962



P-1009963

Charge Storage Device with Piezo Charger

Storage device for electric charge generated by a piezo charger. The stored charge can be transferred from place to place using a so-called "charge-spoon", for example.
Capacitance: 2x 1 nF
Dimensions of storage device: 62x67x50 mm³ approx.
Dimensions of charger: 230x35x40 mm³ approx.
Total weight: 85 g approx.

P-1009963

Additionally recommended:

P-1002707 Charge Spoon, Small



P-1006813

Electrometer Accessories

Set of accessories for carrying out basic experiments on electrostatics, electricity and the photoelectric effect in combination with an electrometer (P-1001025 or P-1001024) and 450 V DC power supply (P-1008535 or P-1008534).

Contents:

- 1 Faraday cup
- 1 Pair of friction rods
- 1 Metal rod with 4 mm drilled hole
- 1 Safety adaptor socket
- 1 plug-in capacitor 1 nF
- 1 plug-in capacitor 10 nF
- 1 plug-in resistor 100 M Ω
- 1 plug-in resistor 1 G Ω
- 1 plug-in resistor 10 G Ω
- 1 Zinc electrode
- 1 Grid electrode

P-1006813

Conducting Spheres with 4 mm Plugs

Conducting spheres for electrostatics experiments, e.g. for determining the capacity of a sphere or for experiments on the influence of nearby objects.

Conducting Sphere, diam. = 85 mm, with 4 mm Plug

P-1000938

Conducting Sphere, diam. = 30 mm, with 4 mm Plug

P-1001026

Additionally recommended:

P-1002710 Drilled Rod



P-1000938

P-1001026



P-1000972

Faraday Cup

Faraday pail with 4 mm plug, e.g. for mounting on an electrostatic voltmeter (P-1003048 or P-1001027) or electrometer amplifier (P-1001025 or P-1001024). Dimensions: 115 mm x 70 mm diam. approx.

P-1000972

Friction Rods

Two rods for experiments on frictional electricity, made of PVC and acrylic.

Length: approx. 250 mm

Diameter: approx. 10 mm

P-1002709

Charge Spoon

Metal plate on insulating rod for charge transport and for experiments on electrostatic induction.

Art. No.	Designation	Length	Plate	Rod
P-1002707	Charge Spoon, small	205 mm	40x35 mm ²	10 mm diam.
P-1002708	Charge Spoon, large	265 mm	40x70 mm ²	10 mm diam.

Experiment Topics:

- Measurement of charge and voltage in electrostatics
- Measurement of charge and voltage for a plate capacitor
- Ionisation of air by burning gases or α radiation
- Hallwachs effect (external photoelectric effect)

P-1001025
P-1001024

Electrometer

Impedance converter with high-resistance input for measuring extremely small charges and currents. The input signal is converted into a proportional voltage, which can then be measured with an external voltmeter. During the measurement the potentials of the electrometer and the experimenter must be matched by using a metal rod connected to earth. Includes a 12 V AC plug-in power supply.

Electrometer gain factor: 1.00

Input resistance: $>10^{12} \Omega$

Output resistance: $<1 \text{ k}\Omega$

Input current: $<10 \text{ pA}$

Input capacitance: $<50 \text{ pF}$

Max. output voltage: $\pm 10 \text{ V}$

Resistance to excess

voltage:

1 kV (from low-resistance sources)

10 kV (from high-resistance sources)

Supply voltage:

12 V AC

Dimensions:

110x170x30 mm³ approx.

Weight:

1 kg approx.

Electrometer (230 V, 50/60 Hz)

P-1001025

Electrometer (115 V, 50/60 Hz)

P-1001024

Additionally recommended:

P-1006813 Electrometer Accessories

P-1003073 Analogue Multimeter AM50

P-1008535 DC Power Supply 450 V (230 V, 50/60 Hz)

or

P-1008534 DC Power Supply 450 V (115 V, 50/60 Hz)

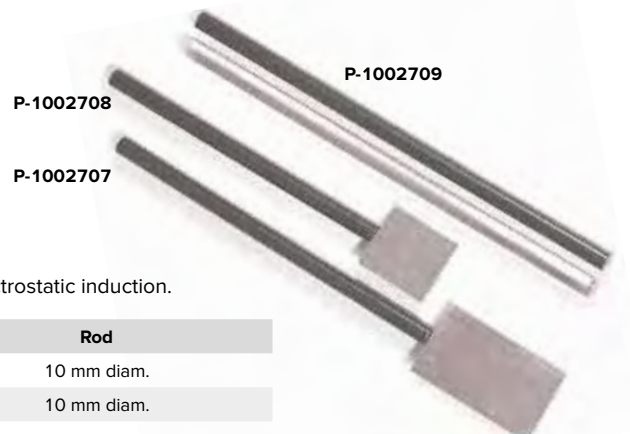

P-1002708

P-1002707

P-1002709

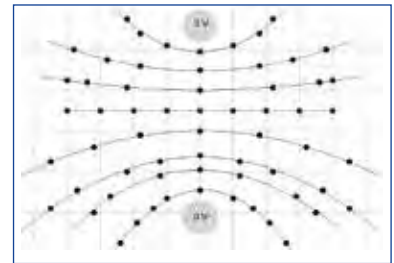
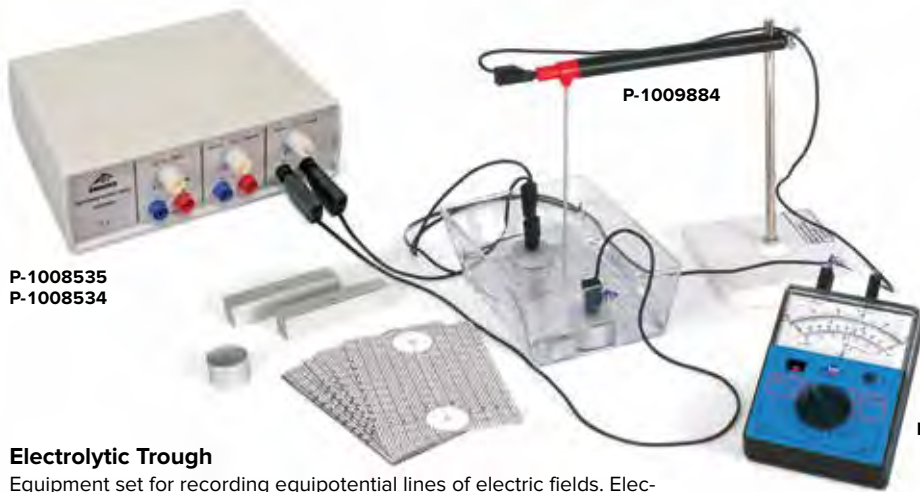

Equipotential lines of point charges

Electrolytic Trough

Equipment set for recording equipotential lines of electric fields. Electrodes of different shapes can be used to measure equipotential lines for a plate capacitor, dipole, induced surface charge and a Faraday beaker.

Trough dimensions: 160x105x65 mm³ approx.

Contents:

- 1 Plastic trough
- 1 Stand with measurement electrode
- 2 Bar electrodes
- 2 Round disc electrodes
- 1 Ring electrode
- 20 Sheets of millimetre-grid paper

P-1009884

Required Apparatus for Experiment UE3020100:

Number / Description	Art. No.
1 Electrometer (230 V, 50/60 Hz) or	P-1001025
Electrometer (115 V, 50/60 Hz)	P-1001024
1 Electrometer Accessories	P-1006813
1 Analogue Multimeter AM50	P-1003073
1 Burette, 10 ml	P-1018065
1 Constantan Wire 0.2 mm / 100 m	P-1000955
1 DC Power Supply 450 V (230 V, 50/60 Hz) or	P-1008535
DC Power Supply 450 V (115 V, 50/60 Hz)	P-1008534
1 Digital Multimeter P3340	P-1002785
1 Digital Stopwatch	P-1002811
1 Tripod Stand 150 mm	P-1002835
1 Stainless Steel Rod 1000 mm	P-1002936
2 Universal Clamp	P-1002830
1 Universal Jaw Clamp	P-1002833
1 Set of 10 Crocodile Clips 4 mm, Not Insulated	P-1019219
1 Set of 3 Safety Experiment Leads for Free Fall Apparatus	P-1002848
2 Pair of Safety Experimental Leads, 75 cm, red/blue	P-1017718
1 Peleus ball, standard	P-1013392
1 Set of 10 Beakers, Low Form	P-1002872
Additionally recommended:	
1 3B NETlog™ (230 V, 50/60 Hz) or	P-1000540
3B NETlog™ (115 V, 50/60 Hz)	P-1000539
1 3B NETlab™	P-1000544

Additionally required:

P-1003073 Analogue Multimeter AM50

P-1008535 DC Power Supply, 450 V (230 V, 50/60 Hz)

or

P-1008534 DC Power Supply, 450 V (115 V, 50/60 Hz)

DIN-B Burette with Schellbach Stripe, 10 ml

Burette tube for measuring small amounts of liquid with Schellbach stripe and tap at the side with standard ground (NS) glass connector and cock plug.

Volume: 10 ml
Scale divisions: 0.02 ml
Error limits: Class B

P-1018065

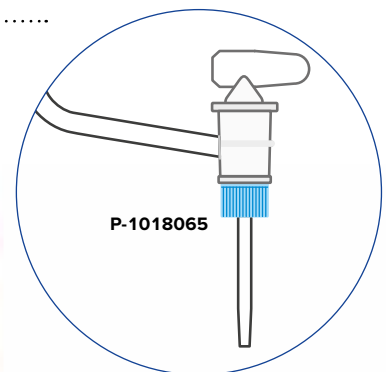

UE3020100
PDF online

Determining the current generated by the movement of the charged water droplets



P-1001030
P-1001029

Experiment Topics:

- Introductory experiments on the functioning of the apparatus
- Electrostatic tests
- Measurement of static electric field strength
- Capacitor tests
- Measurements of potential with an electrostatic meter



Electric Field Meter

Instrument for static measurements of electric field strength or electrical potential. A star-shaped modulation vane-wheel connected to earth is mounted a short distance in front of a measurement electrode, also star-shaped. Influenced by the electric field, the charges generate an alternating current proportional to the field strength. This alternating current is measured via a selective amplifier without the electric field experiencing any average energy loss over time. When used in conjunction with voltage measurement plates, the instrument can be used as an electrostatic voltmeter. The device is protected against excess voltage. A standard DC voltmeter can be used for display.

Max. output voltage: 10 V
 Measurement ranges: 1 V output can correspond to:
 100 V/cm, 300 V/cm, 1000 V/cm
 10 V, 30V, 100 V
 (with 1x voltage measurement plate)
 100 V, 300 V, 1000 V
 (with 10x voltage measurement plate)

Dimensions: 140x110x70 mm³ approx.
 Weight: 1 kg approx.

Contents:

- 1 Electric field meter
- 1 Voltage measurement plate, measuring range 1x
- 1 Voltage measurement plate, measuring range 10x
- 1 Capacitor measurement plate, 250 cm²
- Set of acrylic spacers

Electric Field Meter (230 V, 50/60 Hz)

P-1001030

Electric Field Meter (115 V, 50/60 Hz)

P-1001029

Additionally required:

P-1003073 Analogue Multimeter AM50

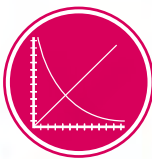
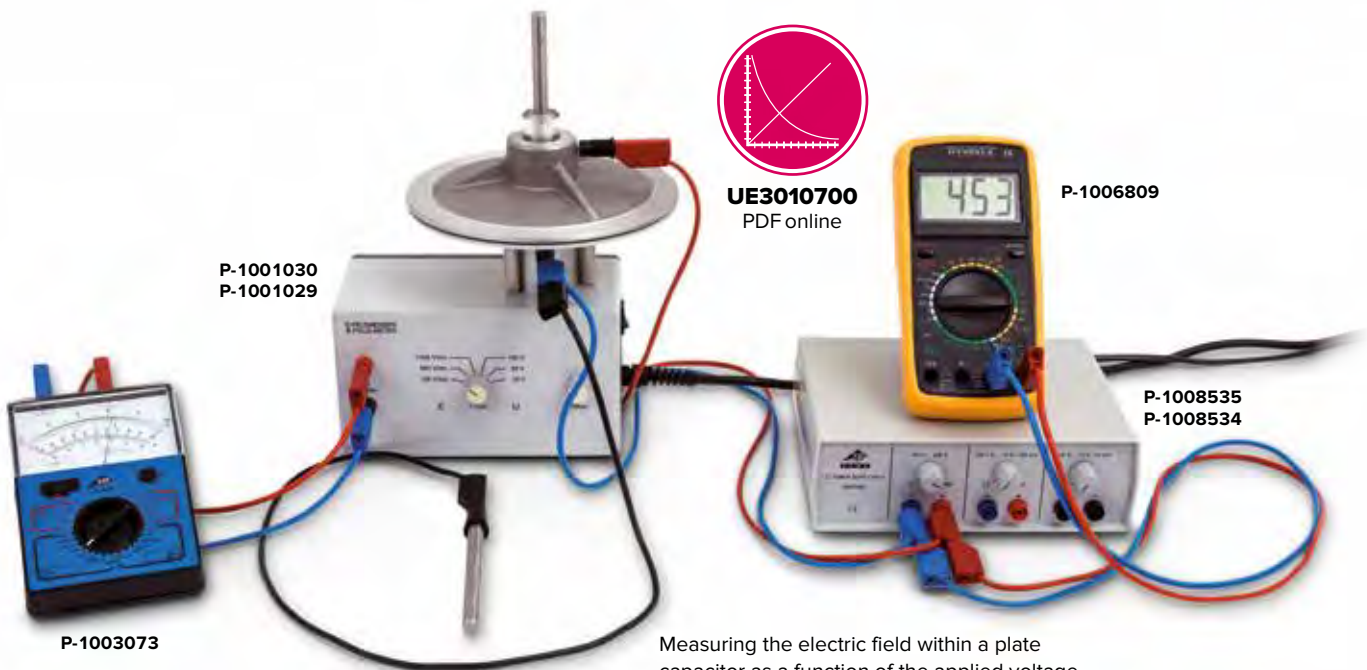

UE3010700
PDF online

P-1006809

P-1001030
P-1001029

P-1008535
P-1008534

P-1003073

Measuring the electric field within a plate capacitor as a function of the applied voltage

! Advantage

- Precise determination of plate separation, reading accuracy $\frac{1}{10}$ mm

Plate Capacitor D

Plate capacitor used to investigate the relationship between electric charge and voltage, quantify capacitance as a function of plate spacing, measure the dielectric constant ϵ and precisely determine the electric field constant ϵ_0 . Plate separation can be finely adjusted and read off from a display to an accuracy of $\frac{1}{10}$ mm.

Plate spacing: 0 – 160 mm

Plates can be adjusted between 0 and 20 mm via a spindle

Plates: Solid castings

Plate area: 500 cm²

Weight: 4.2 kg approx.

P-1006798

Additionally recommended:

P-1000936 Cardboard Plate

P-1000880 Transparent Acrylic Plate

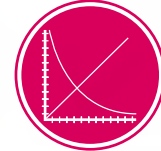
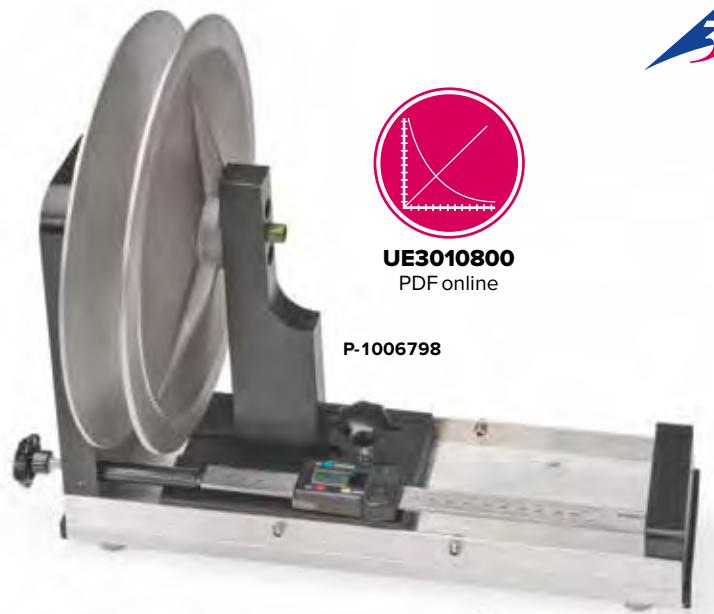

UE3010800
PDF online

P-1006798



P-1000934

P-1001045



P-1000933

P-1001045



P-1000932

P-1001045

Pair of Capacitor Plates

Pair of capacitor plates consisting of light metal castings with electrically isolated handling rod and 4 mm socket connector for constructing a capacitor. The distance between the plates is determined by the acrylic spacers that are provided.

Pair of Capacitor Plates 500 cm²

P-1000932

Pair of Capacitor Plates 250 cm²

P-1000933

Pair of Capacitor Plates 125 cm²

P-1000934

Additionally required:

P-1001045 Barrel Foot, 0.9 kg

Additionally recommended:

P-1000936 Cardboard Plate

P-1000880 Transparent Acrylic Plate

Dielectric Plates

Dielectric plates for experiments with plate capacitors.

Cardboard Plate

Dimensions: 300x300x2 mm³ approx.

Dielectric constant ϵ : 4.5 F/m approx.

P-1000936

Transparent Acrylic Plate

Dimensions: 300x300x2 mm³ approx.

Dielectric constant ϵ : 3.4 F/m approx.

P-1000880



P-1000936

P-1000880

Plate Capacitor S

Plate capacitor used to investigate the relationship between charge, voltage and capacitance, as well as determining the dielectric and electric field constants. It consists of a fixed and a movable plate on a guide rail. A centimeter scale is used to read the plate spacing. The device comes with four dielectric sample plates made of acrylic, bakelite, plywood and cardboard.

Plate spacing: 0 – 150 mm

Plate diameter: approx. 149 mm

Plate area: 175 cm²

Connection: via 4 mm safety jacks

P-1003232

P-1003232





P-1000949 – P-1000953



P-1000955 – P-1000958

Resistance Wires

Metal wires on bobbins, e.g. for experiments to investigate how resistance depends on the material, cross-sectional area and length of the wire.

Art. No.	Material	Length	Diameter
P-1000949	Copper	100 m	0.3 mm
P-1000950	Iron	100 m	0.3 mm
P-1000959	Brass	50 m	0.3 mm
P-1000951	Nickel	50 m	0.3 mm
P-1000953	Chrome-Nickel	100 m	0.3 mm
P-1000954	Chrome-Nickel	50 m	0.5 mm
P-1000955	Constantan	100 m	0.2 mm
P-1000956	Constantan	100 m	0.3 mm
P-1000957	Constantan	50 m	0.4 mm
P-1000958	Constantan	50 m	0.5 mm

Holder for Components

Holder on an acrylic base with two crocodile clips for connecting loose resistors and other electronic components or samples from the “Conductors and Insulators” set. Sockets for 4 mm safety plugs.

P-1008524



P-1008524



P-1000946

Lamp Socket E10 on Acrylic Base

Lamp socket on transparent acrylic base with screw connection for ordinary commercial filament bulbs for E10 sockets. Sockets for 4 mm safety plugs.

P-1000946



P-1000947

Lamp Socket E14 on Acrylic Base

Lamp socket on transparent acrylic base with screw connection for ordinary commercial filament bulbs for E14 sockets. Sockets for 4 mm safety plugs.

P-1000947

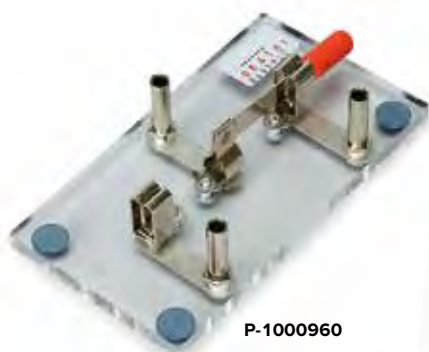

P-1000960

Toggle Switch on Acrylic Base

Switch mounted on a transparent acrylic base for the alternate opening and closing of two electric circuits. Sockets for 4 mm safety plugs.

P-1000960



P-1000962

Momentary Contact Switch on Acrylic Base

Switch mounted on a transparent acrylic base for the momentary closing of circuits. Sockets for 4 mm safety plugs.

P-1000962



P-1000961

Single-Throw Switch on Acrylic Base

Switch mounted on a transparent acrylic base for the alternate opening and closing of a circuit. Sockets for 4 mm safety plugs.

P-1000961



P-1010137

Set of 10 E10 Lamp Sockets

Set of 10 screw-in sockets for lamps with E10 screw thread. Electrical contact is made via uninsulated wires passing through the connecting eyelets in the base or via crocodile clips.

Base: 28 mm diam.

P-1010137



P-1000948

Set of "Conductors and Non-Conductors"

Samples of eight materials for experiments to investigate the electrical conductivities of different materials. In a storage container.

Materials: Iron, aluminium, copper, steel, wood, glass, plastic, cotton

Sample length: approx. 200 mm

Weight: approx. 200 g

P-1000948

Additionally recommended:

P-1008524 Holder for Components



Type A

Type B

Type C

P-1010140 – P-1010199

Set of 10 E10 Bulbs

Set of 10 bulbs with E10 screw-in threads. Lamp design A.

Art. No.	Tension	Current
P-1010142	3.5 V	150 mA
P-1010143	3.5 V	200 mA
P-1010195	3.8 V	300 mA
P-1010196	4 V	40 mA
P-1010197	6 V	50 mA
P-1010144	6 V	100 mA
P-1010145	6 V	350 mA
P-1010140	12 V	100 mA
P-1010141	12 V	500 mA

Set of 10 E10 Bulbs, 6 V, 1 A

Set of 10 6 V, 1 A bulbs with E10 screw-in threads. Lamp design C.

P-1010198

Set of 10 E10 Bulbs, 1.3 V, 60 mA

Set of 10 1.3 V, 60 mA bulbs with E10 screw-in threads. Lamp design B.

P-1010199

Insulator with Clamp

Metal stem with knurled screw and 4 mm bore hole on acrylic rod, as insulated holder for wires, e.g. when conducting experiments on the optical bench are performed.

Diameter: approx. 10 mm

Length: approx. 100 mm

P-1002970



P-1002970

P-1001054

P-1000995

Rod Clamp with Insulator

Clamp for the insulated securing of electrical components with 4 mm connectors. A PVC insulator is used to isolate sections from each other. Upper section features two 4 mm cross bore holes and one 6 mm hole with clamping screw. Lower section with two 4 mm cross holes.

Total length: approx. 205 mm

Stem diameter: approx. 10 mm

Weight: approx. 135 g

P-1001054

Contact Stand with Terminal Sockets

Connection rod on insulated base with three 4mm cross holes and one axial 4 mm bore hole used to secure components with 4 mm connectors or to plug in 4 mm cables. At the top end spring-loaded terminal socket used as a wire clamp.

Height: approx. 130 mm

Shaft: approx. 105x10 mm²

Base: approx. 25x70 mm²

Weight: approx. 210 g

P-1000995



P-1010190



P-1010192



P-1012696



P-1010146



P-1010158



P-1010155



P-1010157



P-1010138



P-1010139



P-1010152

LED on 3B Box

LED in an electrically safe box for assembling simple electric circuits using safety experiment leads. Featuring built-in current limiting resistor and printed circuit symbol.

Maximum voltage: 12 V

Maximum current: 20 mA

Dimensions: 135x85x40 mm³

Red LED on 3B Box

P-1010190

Green LED on 3B Box (not shown)

P-1010191

Battery Holder in 3B Box

Battery holder in an electrically safe box for assembling simple electric circuits using safety experiment leads. Printed circuit symbol and battery direction. Batteries not included.

Battery: 4.5 V, 3R12, flat battery

Dimensions: 135x85x40 mm³

P-1010192

Volta's Pile on 3B Box

Replica of Alessandro Volta's apparatus consisting of series-connected galvanic cells to make up a source of electricity. Zinc and copper plates stacked in alternation on top of each other are separated in each case by a piece of felt soaked in an electrolyte (salt water or acid). The electrolyte makes it possible for electricity to pass between the layers, allowing a voltage to be measured between the plates at the ends.

Connectors: two 4-mm safety sockets

Electrode diameter: 40 mm

Case dimensions: 135x85x40 mm³

P-1010132

Button on 3B Box

Normally open push-button switch attached to a safe box for building simple electric circuits using safety experiment leads. Printed with a circuit symbol.

Maximum voltage: 12 V

Maximum current: 5 A

Dimensions: 135x85x40 mm³

P-1010146

Knife-Edge Switch on 3B Box

Knife-edge switch attached to a safe box for building simple electric circuits using safety experiment leads. Printed with a circuit symbol.

Maximum voltage: 12 V

Maximum current: 5 A

Dimensions: 135x85x40 mm³

P-1010152

Crocodile Clips on 3B Box

Pair of crocodile clips for connecting loose resistors and other electronic components or samples from the "Conductors and Non-Conductors" set. Attached to a safe box for building simple electric circuits using safety experiment leads. Printed with a circuit symbol.

Maximum voltage: 12 V

Maximum current: 2 A

Dimensions: 135x85x40 mm³

P-1010155

Additionally recommended:

Steel wool

P-1000948 "Conductors and Non-Conductors" Set

Diode in 3B Box

1N4002 semiconductor in an electrically safe box for assembling simple electric circuits using safety experiment leads. Featuring printed circuit symbol.

Maximum voltage: 12 V

Maximum current: 1 mA

Dimensions: 135x85x40 mm³

P-1010157

ELV Motor on 3B Box

Low-voltage motor with pulley for simple experiments on mechanical and electrical energy. The relationship between current direction and direction of rotation is immediately obvious. Built onto an electrically safe box for assembling simple electric circuits using safety experiment leads. Printed circuit symbol.

Voltage: 4 – 6 V DC

Box dimensions: 135x85x40 mm³

P-1010158

E10 Lamp Socket on 3B Box

E10 lamp socket attached to a safe box for building simple electric circuits using safety experiment leads. Printed with a circuit symbol.

Maximum voltage: 12 V

Maximum current: 2 A

Dimensions: 135x85x40 mm³

P-1010138

Switch on 3B-Box

Switch attached to a safe box for building simple electric circuits using safety experiment leads. Printed with a circuit symbol.

Maximum voltage: 12 V

Maximum current: 5 A

Dimensions: 135x85x40 mm³

P-1010139



Coil with 600 Windings on 3B-Box

600-winding coil without core attached to a safe box and featuring safety sockets. For experiments on induction, a bar magnet can be passed through the coil.

Dimensions: 135x85x40 mm³

P-1011346

Additionally recommended:

P-1002726 Zero-Point Galvanometer, CA 403

P-1003112 Bar Magnet

Graetz Bridge in 3B Box

Bridge rectifier circuit consisting of four semiconductor diodes connected in Graetz configuration. Inside a safe box for building simple electric circuits using safety experiment leads. Printed with circuit symbols.

Maximum voltage: 12 V

Maximum current: 20 mA

Dimensions: 135x85x40 mm³

P-1012695

Fuse Holder on 3B Box

Fuse holder attached to a safe box for building simple electric circuits using safety experiment leads. Printed with a circuit symbol.

Fuses (not included): 20 mm x 5 mm diam.

Maximum voltage: 12 V

Maximum current: 5 A

Dimensions: 135x85x40 mm³

P-1010154

Current Direction Indicator in 3B Box

Circuit comprised of two LEDs for indicating the direction of current. Inside a safe box with sockets for safety experiment leads. Printed with circuit symbols.

Maximum voltage: 12 V

Maximum current: 20 mA

Dimensions: 135x85x40 mm³

P-1012697

Change-Over Switch (SPDT) on 3B Box

Single-pole double-throw change-over switch attached to a safe box for building simple electric circuits using safety experiment leads.

Printed with a circuit symbol.

Maximum voltage: 12 V

Maximum current: 5 A

Dimensions: 135x85x40 mm³

P-1012694

Ohm's Law Apparatus in 3B Box

Classic set-up for verifying Ohm's law for a two-pole resistor. Inside a safe box with sockets for safety experiment leads. Printed with circuit symbols.

Maximum voltage: 12 V

Maximum current: 2 A

Dimensions: 135x85x40 mm³

P-1012698

Universal Holder on 3B Box

Universal holder for two-pole components (resistors, capacitors, diodes, LEDs) attached to a safe box for building simple electric circuits using safety experiment leads. Printed with a circuit symbol.

Dimensions: 135x85x40 mm³

P-1010156

"Simple Electric Circuit" Experiment

Set consisting of:

1x Battery holder in 3B Box

1x Knife-edge switch on 3B Box

1x E10 lamp socket on 3B Box

1x Set of 10 E10 bulbs

2x Pair of safety experiment leads, 75 cm

P-1013825

LED Graetz Bridge in 3B Box

Bridge rectifier circuit consisting of four LEDs connected in Graetz configuration. Inside a safe box for building simple electric circuits using safety experiment leads. Printed with circuit symbols.

Maximum voltage: 12 V

Maximum current: 20 mA

Dimensions: 135x85x40 mm³

P-1012696

Unknown Resistors in 3B Box

Four unknown resistors which can be connected separately in two series circuits. Inside a safe box with sockets for safety experiment leads. Printed with circuit symbols.

Maximum voltage: 6 V

Maximum current: 200 mA

Dimensions: 135x85x40 mm³

P-1012699

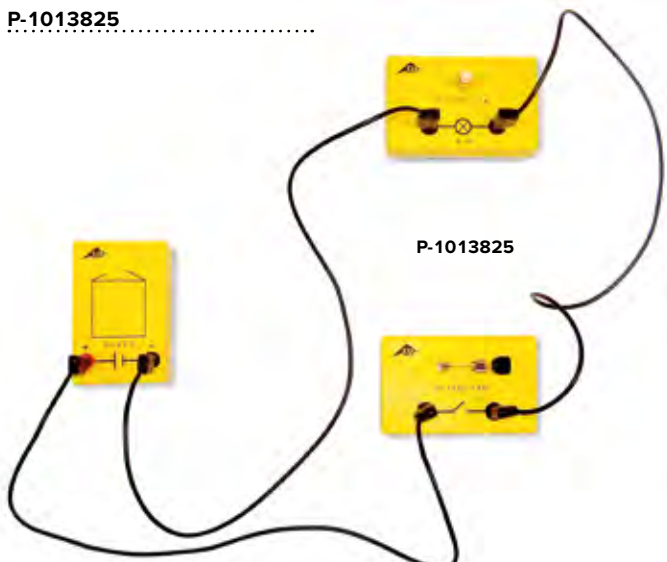



UE3020300
PDF online



P-1009885

Resistance Bridge

Resistance Bridge used to measure resistances in bridge circuits and investigate voltage drops across wires. The device is only suitable for low voltages. It consists of a rail with a scale mounted at two points and a resistance wire stretched between two connecting sockets. A sliding contact on the resistance wire is used to set the resistance of the resultant two wire sections. A Wheatstone bridge circuit is configured to determine unknown resistances.

- Dimensions: approx. 1300x100x90 mm³
- Rail: approx. 30x30 mm²
- Scale: 0 – 1000 mm
- Scale divisions: mm
- Resistance wire: 1 m, 0.5 mm diam.
- Material: NiCr
- Resistance: 5.3 Ω
- Connection: 4 mm safety jacks
- Maximum permissible voltage: 8 V
- Maximum permissible current: 1.5 A

P-1009885

Additionally recommended:

- P-1002726 Zero Galvanometer CA 403**
- P-1002730 Resistance Decade 1 Ω**
- P-1002731 Resistance Decade 10 Ω**
- P-1002732 Resistance Decade 100 Ω**
- P-1009843 High-Precision Resistor 1 Ω**
- P-1009844 High-Precision Resistor 10 Ω**
- P-1002776 AC/DC Power Supply Unit 0 – 12 V, 3 A (230 V, 50/60 Hz) or**
- P-1002775 AC/DC Power Supply Unit 0 – 12 V, 3 A (115 V, 50/60 Hz)**



P-1009949



UE3020320
PDF online

Resistance Apparatus

Apparatus to investigate the dependency of electrical resistance on conductor length, conductor cross-section and material. Six wires are laid out side by side on a metal base and both ends connect to 4 mm sockets.

- Wire specimens: Constantan 1.0 mm diam.,
Constantan 0.7 mm diam. (2x),
Constantan 0.5 mm diam.,
Constantan 0.35 mm diam.,
Brass 0.5 mm diam.
- Wire lengths: 1000 mm
- Dimensions: approx. 1085x120x50 mm³
- Weight: approx. 1.35 kg

P-1009949



P-1000689



P-1009844

Capacitor 2200 µF

- Capacitor in plastic housing with 4mm safety plugs.
- Capacitance: 2200 µF
- Tolerance: 20%
- Max. permissible voltage: 40 V
- Dimensions: approx. 122x70x50 mm³

P-1000689

High Precision Resistors

High precision resistors in plastic housing with 4 mm safety plugs.
Dimensions: approx. 122x70x50 mm³

Art. No.	Resistance	Tolerance	Load rating
P-1009843	1 Ω	1%	4 W
P-1009844	10 Ω	1%	4 W
P-1009886	100 Ω	1%	4 W
P-1009887	1 kΩ	1%	4 W
P-1000685	10 kΩ	1%	4 W
P-1000686	100 kΩ	1%	1 W
P-1000690	300 kΩ	5%	1 W
P-1000687	1 MΩ	1%	1 W
P-1000688	10 MΩ	1%	1 W



P-1002735

Resistance Decade, 1 Ω – 10 k Ω

Four resistance decades in a single housing, can be used individually or in combination, e.g. for setting up a Wheatstone bridge. Can be set using control knob, with decade scale.

Output: via 4 mm safety sockets
 Max. current: 700 mA (1 Ω – 10 Ω),
 200 mA (10 Ω – 100 Ω),
 70 mA (100 Ω – 1 kΩ),
 20 mA (1 kΩ – 10 kΩ)
 Accuracy: 1%
 Dimensions: approx. 310x90x80 mm³
 Weight: approx. 1 kg

P-1002735



P-1003062 – P-1003069

Rheostats

Slide-contact resistors of high current-bearing capacity in housings that are safe to touch, for experiments with safety low voltage circuits, to be used as continuously variable resistors or voltage dividers. With built-in earth sockets.

Resistance tolerance: 10% from nominal value
 Max. permissible power: 320 W (continuous operation),
 640 W (max. 15min)
 Max. permissible voltage: 600 V
 Terminals: 4 mm safety sockets
 Dimensions: approx. 446x93x150 mm³
 Weight: approx. 2.85 kg to 3.25 kg

Art. No.	Resistance	Max. current rating (continuous)	Max. current rating (15 min)
P-1003062	1 Ω	18 A	25 A
P-1003063	3.3 Ω	10 A	12 A
P-1003064	10 Ω	5.7 A	8 A
P-1003065	33 Ω	3.1 A	4.4 A
P-1003066	100 Ω	1.8 A	2.5 A
P-1003067	330 Ω	1 A	1.4 A
P-1003068	1000 Ω	0.57 A	0.8 A
P-1003069	3300 Ω	0.31 A	0.44 A



P-1002736 – P-1002737

Capacitance Decades

Capacitance decades which can be mechanically connected to one another. With colour-coded safety sockets and control knob for setting capacitances in 10 steps. Includes 25 cm safety patch cord.

Nominal voltage: 350 V DC
 Connections: 4 mm safety sockets
 Dimensions: approx. 72x72x90 mm³
 Weight: approx. 220 g

Art. No.	Measurement range	Step size	Accuracy
P-1002736	0.01 μF – 0.1 μF	0.01 μF	2%
P-1002737	0.1 μF – 1 μF	0.1 μF	2%

Resistance Decades

Resistance decades which can be mechanically connected to one another, e.g. in order to assemble a Wheatstone bridge. With colour-coded safety sockets and control knob for setting measurement resistances in 10 steps. Includes 25 cm safety patch cord.

Connections: 4 mm safety sockets
 Dimensions: approx. 72x72x90 mm³
 Weight: approx. 220 g

Art. No.	Measurement range	Step size	Max. current	Accuracy
P-1002730	0.1 Ω – 1 Ω	0.1 Ω	1 A	1% ±5 mΩ
P-1002731	1 Ω – 10 Ω	1 Ω	750 mA	1% ±5 mΩ
P-1002732	10 Ω – 100 Ω	10 Ω	250 mA	0.5%
P-1002733	100 Ω – 1 kΩ	100 Ω	75 mA	0.5%
P-1002734	1 kΩ – 10 kΩ	1 kΩ	25 mA	0.5%

P-1002730 – P-1002734



Experiment Topics:

- Assembly of a bell circuit
- Assembly of a relay
- Assembly of a bimetallic switch circuit



P-1000994

Assembly Kit “Bell, Relay and Bimetallic Switch”

Equipment kit comprising materials to assemble electromagnetic switches and bimetallic switches.

Base plate: approx. 200x140x40 mm³
 Weight: approx. 1.6 kg

Contents:

- 1 Stand plate with 3 clamps
- 1 Bell, 70 mm in diameter
- 2 Contact rods with three 4 mm cross holes
- 1 Leaf spring with connector
- 1 Bimetallic strip with connector
- 1 Armature with connector
- 1 Contact pin with connector
- 1 U-core, 20x20 mm²
- 1 Coil, 800 turns

P-1000994

Additionally required:

- Bulb, 12 V, 25 W, Type E14**, to replace blown components
- P-1000947 Lamp Socket E14**
- P-1003316 Transformer with Rectifier (230 V, 50/60 Hz)**
- or
- P-1003315 Transformer with Rectifier (115 V, 50/60 Hz)**

Inductance Decade

Variable inductance decade in impact-resistant plastic housing. This series incorporates mechanically stable components, a slide switch for setting measurement ranges and 4-mm safety sockets to ensure that all connections are safe.

Measuring range: 10 μH – 111.1 mH
 Increment: 10 μH
 Accuracy: 5%
 Number of decades: 4
 Limiting values: max. 100 mA AC/DC
 Dimensions: 140x190x80 mm³
 Weight: 450 g

P-1013905



P-1013905

P-1013906

Capacitance Decade

Capacitance decade in impact-resistant plastic housing. This series incorporates mechanically stable components, a slide switch for setting measurement ranges and 4-mm safety sockets to ensure that all connections are safe.

Measuring range: 100 pF – 111.1 μF
 Increment: 100 pF
 Accuracy: 5%
 Number of decades: 5
 Limiting values: max. 50 V DC
 Dimensions: 140x190x80 mm³
 Weight: 350 g

P-1013906

Experiment Topics:

- Ohm's law
- Parallel resistor circuits
- Series resistor circuits
- Unknown resistance
- Potentiometers
- Voltage dividers with no load
- Voltage dividers with load
- Discharge of a capacitor
- Bridge rectifiers
- Half-wave rectifiers
- Characteristic curve for a lamp
- Characteristic curve for an LED
- Characteristic curve for a silicon diode
- Characteristic curve for a zener diode
- LC parallel resonant circuit
- LC series resonant circuit
- RLC series resonant circuit

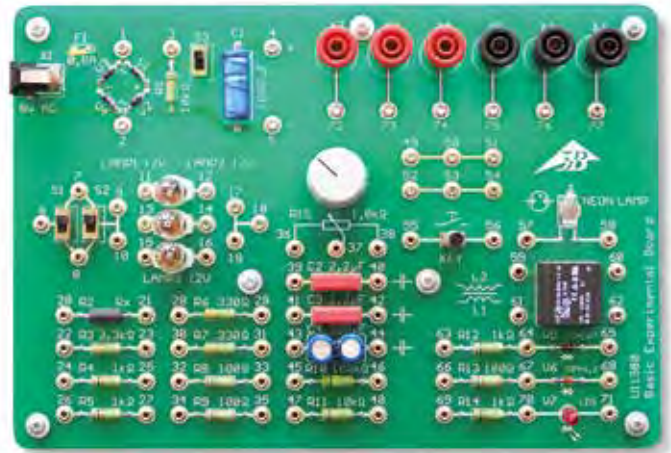

P-1000573 / P-1000572

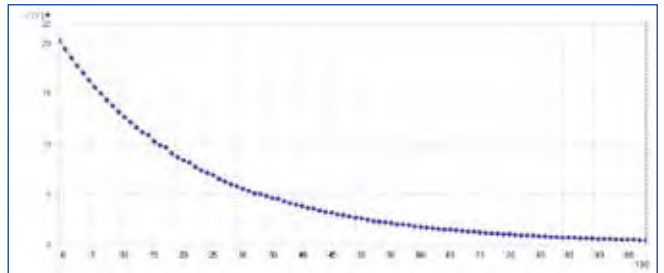

Discharge curve of a capacitor

Basic Experiment Board

Experiment board with basic circuits for electricity and electronics: circuit components, Ohm's law, Kirchhoff's laws, rheostat and potentiometer circuits, two way switching, charging and discharging curves of a capacitor, inductive effects in DC and AC circuits. Simple semiconductor circuits for determining diode characteristics, rectifier circuits, filter factors. The components can be interconnected via 2 mm sockets using jumpers and experiment leads. Six 2 mm/4 mm safety socket adaptors are provided for connecting 4 mm experiment leads.

Contents:

- 10 Leads (5 red and 5 blue) with 2 mm plugs, 20 cm long
- 10 Jumpers
- 1 Plug-in power supply 8 V AC/500 mA
- 1 board with the following electronic components:
 - 13 0.5 W resistors ranging from 100 Ω – 100 k Ω
 - 1 Potentiometer, 1 k Ω
 - 3 Filament lamps, 12 V
 - 2 Slide switches
 - 5 Capacitors (2x 2.2 μ F, 1x 100 μ F [bipolar], 1x 1000 μ F)
 - 5 1 A rectifier diodes
 - 1 Zener diode
 - 1 Red light emitting diode
 - 1 Neon fluorescent light
 - 1 Transformer, 12 V
- Dimensions: approx. 233x160 mm²

Basic Experiment Board (230 V, 50/60 Hz)

P-1000573

Basic Experiment Board (115 V, 50/60 Hz)

P-1000572

Additionally recommended:

P-1003073 Analogue Multimeter AM50

or

P-1000544 3B NETlab™

P-1000540 3B NETlog™ (230 V, 50/60 Hz)

or

P-1000539 3B NETlog™ (115 V, 50/60 Hz)

P-1009957 Function Generator FG 100 (230 V, 50/60 Hz)

or

P-1009956 Function Generator FG 100 (115 V, 50/60 Hz)

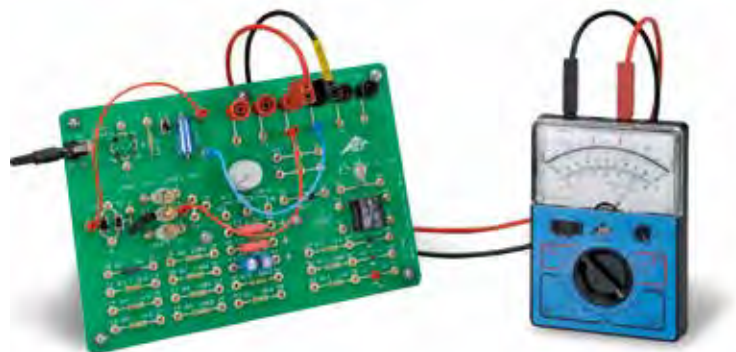

Measurement of the discharge of a capacitor



Measurement of the discharge of a capacitor



Characteristic curve for a zener diode

Plug-in Board and Components for Building Electrical and Electronic Circuits in Demonstrations or Students' own Experiments



UE3050101
UE3050321
PDF online

Plug-in board with components to build a power controller

Plug-in Board for Components

Plug-in board for assembling electrical and electronic circuits using components in plug-in housings. Features 4-mm sockets on the front and rear, each internally connected to a square of 9 sockets plus two continuous serial layouts each with 12 sockets. Two adjacent plug-in boards can be connected together via plug-in components to make a board that is twice as big.

Connector squares: 16 complete squares and four half-squares

Socket separation: 19 mm from edge to edge of connector squares
50 mm from centre to centre of connector squares

Dimensions: 300x200x24 mm³

P-1012902

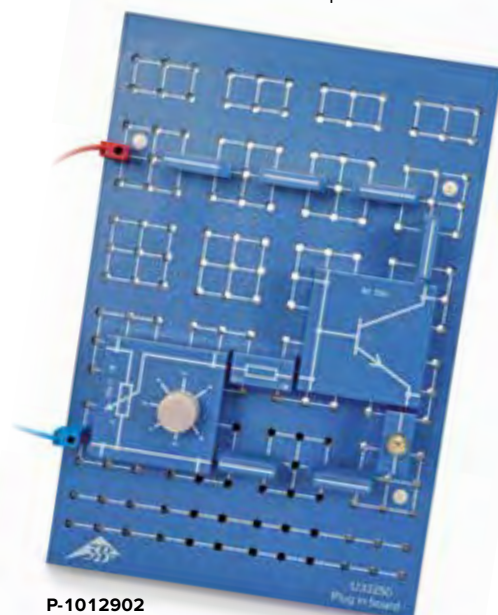

P-1012902

Pick out the individual components for your circuit yourself. Ask us about bulk discounts, even when ordering a mix of components in large numbers.

Components in Plug-in Housings with Two Plugs Separated by 19 mm

Capacitors

Art. No.	Capacitance	Tolerance	Max. tension
P-1012947	100 pF	20%	160 V
P-1012948	470 pF	20%	160 V
P-1012949	1 nF	20%	100 V
P-1012950	2.2 nF	20%	160 V
P-1012951	4.7 nF	2.5%	100 V
P-1012952	10 nF	20%	100 V
P-1012943	22 nF	20%	100 V
P-1012944	47 nF	5%	100 V
P-1012945	0.22 μF	5%	250 V
P-1012946	4.7 μF	5%	63 V
P-1012953	0.1 μF	20%	100 V
P-1012954	0.47 μF	20%	100 V
P-1012955	1 μF	20%	100 V
P-1012956	2.2 μF	5%	63 V



P-1012910



P-1012947



P-1012959

Electrolytic Capacitors

Art. No.	Capacitance	Tolerance	Max. tension
P-1012957	10 μF	20%	35 V
P-1012958	47 μF	20%	35 V
P-1012959	100 μF	20%	35 V
P-1012960	470 μF	20%	16 V
P-1017806	1000 μF	20%	35 V

Linear Resistors

Art. No.	Resistance	Tolerance	Max. power
P-1012903	1 Ω	5%	2 W
P-1012904	10 Ω	5%	2 W
P-1012905	10 Ω	5%	10 W
P-1012906	5.1 Ω	5%	2 W
P-1012907	22 Ω	5%	2 W
P-1012908	47 Ω	5%	2 W
P-1012909	68 Ω	5%	2 W
P-1012910	100 Ω	5%	2 W
P-1012911	150 Ω	5%	2 W
P-1012912	220 Ω	5%	2 W
P-1012913	330 Ω	5%	2 W
P-1012914	470 Ω	5%	2 W
P-1012915	680 Ω	1%	2 W
P-1012916	1 kΩ	5%	2 W
P-1012917	1.5 kΩ	5%	2 W
P-1012918	2.2 kΩ	5%	2 W
P-1012919	3.3 kΩ	5%	2 W
P-1012920	4.7 kΩ	5%	2 W
P-1012921	6.8 kΩ	5%	2 W
P-1012922	10 kΩ	5%	0.5 W
P-1012923	15 kΩ	5%	0.5 W
P-1012924	22 kΩ	5%	0.5 W
P-1012925	33 kΩ	5%	0.5 W
P-1012926	47 kΩ	5%	0.5 W
P-1012927	68 kΩ	1%	0.5 W
P-1012928	100 kΩ	5%	0.5 W
P-1012929	220 kΩ	5%	0.5 W
P-1012930	330 kΩ	5%	0.5 W
P-1012931	470 kΩ	5%	0.5 W
P-1012932	1 MΩ	5%	0.5 W
P-1012933	10 MΩ	5%	0.5 W



P-1012962



P-1012966



P-1012964



P-1012988



P-1012983



P-1012990

LEDs

Art. No.	Colour	Orientation
P-1012962	red	upward facing
P-1012971	green	upward facing
P-1012972	red	side facing
P-1018837	yellow	upward facing
P-1018839	infrared	side facing

Zener Diodes

Art. No.	Type	Max. power dissipation
P-1012965	ZPD 3.3	0.5 W
P-1012966	ZPD 9.1	0.5 W
P-1012967	ZPD 6.2	0.5 W
P-1012968	ZPY 5.6	1.3 W
P-1012969	ZPY 8.2	1.3 W
P-1012970	ZPD 18	0.5 W

Semiconductor Diodes

Art. No.	Type	Material	Cut-off voltage	Max. long-term current
P-1012964	1N 4007	Si	1000 V	1 A
P-1012961	BY 255	Si	1300 V	3 A
P-1012963	AA 118	Ge	90 V	50 mA

Thermistors Max. temperature:

Art. No.	Type	Resistance (25°C)	Resistance (100°C)
P-1012941	NTC	2.2 kΩ	120 Ω
P-1012942	PTC	100 Ω	

Voltage Dependent Resistor

Characteristic voltage at 1 mA:
8 V (DC) approx.

P-1018841

Phototransistor BPX43

Phototransistor for use as light-sensitive switch.

Range of sensitivity: 450 – 1100 nm

Max. operating voltage: 32 V
Max. current load: 100 mA
Max. Power dissipation: 0.3 W

P-1018842



P-1012941



P-1018844



P-1012940



P-1012973



P-1018842

Single-Pole Push-Button Switches

Art. No.	Type
P-1012988	Normally open
P-1012989	Normally closed

Coils

Art. No.	Type	Inductance
P-1012983	Coil	10 mH
P-1012984	High-Frequency Coil	33 mH

Single-Pole Rocker Switch

P-1012990

Micromotor 1.5 V DC

Miniature motor with gearbox permanently fixed to the side.

Operating

voltage: 0.5 – 1.5 V DC

Gear ratio: 40 : 1

P-1012995



P-1012995

LDR 05 Photoresistor

Resistance: 100 Ω (bright light)
– 10 MΩ (dark)

Max. power

dissipation: 0.2 W

P-1012940

BR 100 Diac

BR100 diac in a plug-in housing printed with the appropriate circuit symbol.

Breakdown voltage: 32 V approx.

Breakdown current: 50 μA approx.

P-1012973

Silicon Photovoltaic Cell BPY47P

Range of sensitivity: 420 – 1060 nm

Max. sensitivity: 820 nm

Open-circuit voltage: 0.45 V

Short-circuit current: 1.4 mA

Max. current load: 100 mA

Max. Power dissipation: 0.3 W

P-1018844

Additionally recommended:

Holder for Plug-in Components

P-1018449

Components in Plug-in Housings with Four Plugs Separated by 50 mm



P-1012939



P-1012974



P-1012975



P-1018847

Potentiometers

Art. No.	Resistance	Max. power
P-1012934	220 Ω	1 W
P-1012935	470 Ω	1 W
P-1012936	1 kΩ	1 W
P-1012937	10 kΩ	1 W
P-1012938	4.7 kΩ	1 W
P-1012939	100 kΩ	1 W

Transistors

Art. No.	Type	Current gain	Power dissipation
P-1012974	NPN BD137	40 – 250	5 W
P-1018845	NPN BC140	100 – 250	0.8 W
P-1012976	NPN BC550	420 – 800	0.5 W
P-1012975	PNP BD138	40 – 250	5 W
P-1018846	PNP BC160	100 – 250	3.7 W
P-1012977	PNP BC560	420 – 800	0.5 W
P-1018847	Darlington TIP 162	approx. 200	max. 3 W



P-1012978



P-1012979



P-1012980

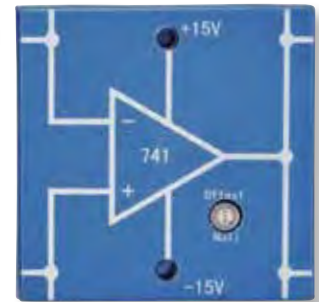

P-1012981

BF 244 Field Effect Transistor

Type: BF244, N-channel-FET
Power dissipation: 300 mW

P-1012978

TYN 1012 Thyristor

Type: TYN 1012, N-channel FET
Cut-off current: 8 A

P-1012979

BT 137/800 Triac

Type: BT 137/800
Cut-off current: 3 A

P-1012980

LM 741 Operational Amplifier

Operating voltage: ±15 V DC
Output current: 15 mA

P-1012981

Double-Pole Change-Over Switch

Mechanical rocker switch with two switch positions on a square plug-in housing printed with the appropriate circuit symbol. Internal mechanical coupling with two change-over switches for each of the three switch positions to be reproduced in two circuits.
Switch functions: 2 x ON-OFF, 2 x OFF-ON, 2 x ON-OFF-ON, 2 x Change-over

P-1012991

Relay with Change-Over Contacts

Control voltage: 4–16 V DC
Coil resistance: 150 Ω approx.
Maximum switched power: 50 VA

P-1012992

Low-Frequency Transformer, 1:2

P-1012982

Single-Pole Change-Over Switch

P-1012993



P-1012991

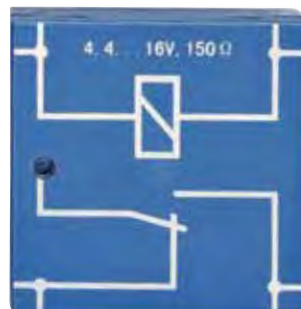

P-1012992

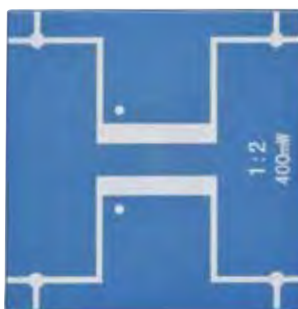

P-1012982

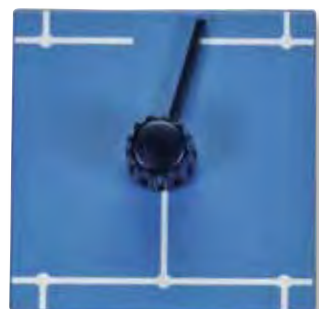

P-1012993



P-1012987



P-1012985



P-1012994

E 10 Socket

Art. No.	Type
P-1012986	Socket side facing
P-1012987	Socket upward facing

Additionally required:

E10 bulb from **P-1010140**, **P-1010141**, **P-1010142**, **P-1010143**, **P-1010144**, **P-1010145**, **P-1010195**, **P-1010196**, **P-1010197**, **P-1010198** or **P-1010199**

Set of 10 Jumpers

Set of 10 jumpers with printed lines showing the connection between the two plugs, for assembling circuits on the plug-in component board (P-1012902).
Max. permitted current: 25 A
Plug separation: 19 mm

P-1012985

Battery Holder

Open housing with connectors for type IEC R 20 1.5-V batteries.
Plugs: 2
Plug separation: 50 mm

P-1012994

Experiment topics

- Characteristics of a semiconductor diode
- Characteristic of an LED
- Characteristic of a zener diode
- Transistors
- Characteristics of a transistor
- LDR photoresistor (light dependent resistor)
- Thyristors in DC circuits
- Temperature response of NTC and PTC thermistors
- Delayed switching processes
- Characteristics of a field effect transistor
- Check for mains hum
- Bridge rectifiers



Set of Components for Electronics Experiments

Assortment of components for basic experiments in the area of electronics using a component plug-in board. In a storage case with matching foam inlay.

Contents:

- 1 Set of 10 Jumpers
- 1 Resistor 100 Ω, 2W
- 1 Resistor 470 Ω, 2 W
- 1 Resistor 1 kΩ, 2 W
- 1 Resistor 4.7 kΩ
- 1 Resistor 10 kΩ, 0.5 W
- 1 Resistor 47 kΩ, 0.5 W
- 1 Electrolytic Capacitor 100 μF, 35 V
- 1 Electrolytic Capacitor 470 μF, 16 V
- 1 E 10 Socket, socket upward facing
- 1 Set of 10 bulbs, 12 V; 100 mA
- 1 Set of 10 bulbs, 4 V; 40 mA
- 1 Single-Pole Rocker Switch
- 1 Single-Pole Push-Button Switches, normally open
- 1 Single-Pole Push-Button Switches, normally closed
- 4 Si-Diodes 1N 4007
- 1 Ge-Diode
- 1 Zener Diode ZPD 6.2
- 1 LED green
- 1 LED, red

- 1 LDR 05 Photoresistor
- 1 NTC Thermistor 2.2 kΩ
- 1 PTC Thermistor 100 Ω
- 1 Potentiometer 220 Ω, 3 W
- 1 NPN Transistor BD 137
- 1 PNP Transistor BD 138
- 1 BF 244 Field Effect Transistor
- 1 TYN 1012 Thyristor
- 1 Single-Pole Change-Over Switch
- 1 Set of earpiece headphones

P-1018532

Additionally required:

P-1012902 Plug-in Board for Components

P-1013526 Analogue Multimeter ESCOLA 30

P-1002840 Set of 15 Experiment Leads, 75 cm

P-1002776 AC/DC Power Supply 0 – 12 V, 3 A (230 V, 50/60 Hz) or

P-1002775 AC/DC Power Supply 0 – 12 V, 3 A (115 V, 50/60 Hz)

Experiment Topics:

- Measurement of charging and discharging curves for pairs of RC components
- Determination of ratings of integrated resistors
- Determination of ratings of integrated capacitors
- Determination of rating of an electrolytic capacitor
- Estimation of bounce times

P-1017781
P-1017780



Measurement at an external RC pair

Charge and Discharge Apparatus

Compact equipment for recording charging and discharging curves for capacitors at individual points. Includes 12 V AC plug-in power supply. The charger and discharger consists of three units in a single housing: a voltage comparator, a digital counter and three resistor-capacitor pairs. The comparator compares the charging and discharging voltages with a set comparison voltage, which can be selected from any of 11 values between 0 to 10 V. The digital counter indicates the charging and discharging times for the capacitor as soon as the set comparison voltage is attained. In addition there are pairs of sockets for connecting an external resistor and an external capacitor.

Internal capacitor: 2067 μF
 Internal resistors: 2.2 k Ω , 5.1 k Ω , 10 k Ω
 Digital counter: 4-digit, quartz controlled
 Maximum value: 200 s
 Resolution: 100 ms
 Power supply: 12 V AC, 2000 mA plug-in power supply
 Dimensions: 260x220x55 mm³ approx.
 Weight: 1700 g, including plug-in power supply

Charge and Discharge Apparatus (230 V, 50/60 Hz)

P-1017781

Charge and Discharge Apparatus (115 V, 50/60 Hz)

P-1017780

Additionally recommended:

- P-1017806 Capacitor 1000 μF
- P-1012920 Resistor 4.7 k Ω
- P-1012922 Resistor 10 k Ω
- P-1012924 Resistor 22 k Ω



UE3050105
PDF online

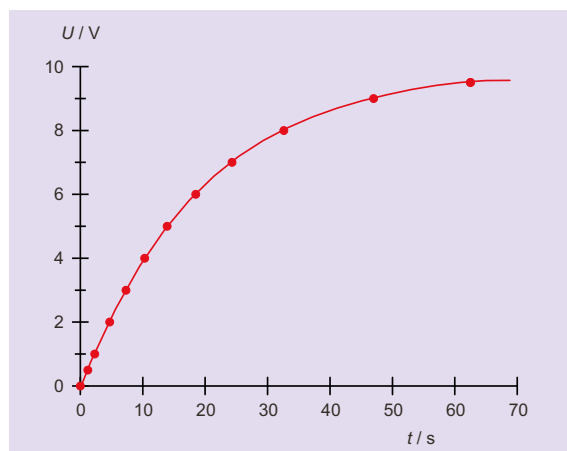

Charging curve

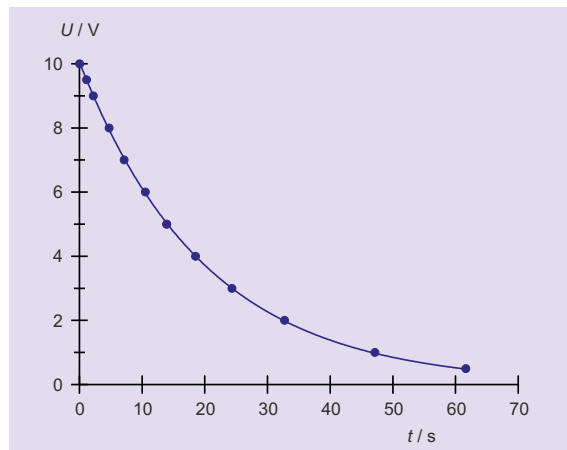

Discharging curve

Experiment Topics:

- Measurement at galvanic voltage sources
- Daniell cell, series and parallel circuits
- Electrochemical potentials (voltage sequence)
- Determination of the standard potentials of different metals and non metals
- How potentials depend on concentration
- How potentials depend on temperature
- Charge and discharge of a steel accumulator
- Leclanché cell
- Measurement of pH values



P-1002719



Electrochemistry Case

A complete equipment set in a case for basic experiments on electrochemistry. A cell block made of tough plastic, which can be unscrewed into two halves for ease of cleaning, allows four galvanic cells to be connected in parallel. A piece of filter paper stretched between the two halves of the cell acts as a diaphragm. Includes a handy, high-resistance meter for measuring potential differences with very little current and measuring pH values with the help of the supplied pH measuring probe.

Measurement device:

7 segment display:	3 digit
Height:	13 mm
Voltage ranges:	2 V DC and 20 V DC
Resolution:	1 mV
Input resistance:	200 MΩ
pH measuring range:	0.0 – 14.0 pH
Power supply:	Plug-in power supply, 12 V/0.5 A (as supplied) or 9-V block battery
Dimensions:	approx. 175x105x55 mm ³

pH Combined Electrode

pH combined electrode with shaft made of plastic with a BNC plug and highly flexible cable.

Length of cable:	approx. 1 m
Dimensions:	approx. 120 mm x 12 mm diam.

P-1002720

P-1002720



Contents:

- 1 foam lined case
- 1 measurement device
- 1 pH combined electrode with BNC plug
- 1 plug-in power unit 12 V DC / 500 mA for 115/230 V AC mains voltage
- 1 Cell block, fitted with filter paper
- 2 Ag-electrodes, 42x28 mm²
- 1 Pt-electrode, 42x28 mm²
- 4 Zn-electrodes, 42x28 mm²
- 2 Fe-electrodes, 42x28 mm²
- 2 C-electrodes, 42x28 mm²
- 2 Al-electrodes, 42x28 mm²
- 2 Ni-electrodes, 42x28 mm²
- 4 Cu-electrodes, 42x28 mm²
- 1 Mg-electrode, 42x28 mm²
- 1 set of filter papers (50 units)
- 1 Sanding block for cleaning electrodes
- 3 experiment cables with crocodile clips, 20 cm, red
- 3 experiment cables with crocodile clips, 20 cm, blue
- 1 experiment cable with crocodile clip and 2 mm plug, 30 cm, red
- 1 experiment cable with crocodile clip and 2 mm plug, 30 cm, blue
- 2 graduated plastic beakers, 25 ml
- 2 drip pipettes with suction bulbs
- 1 Storage box with loose insert
- 1 operating instructions on CD-ROM

P-1002719

Additionally required:

Chemicals

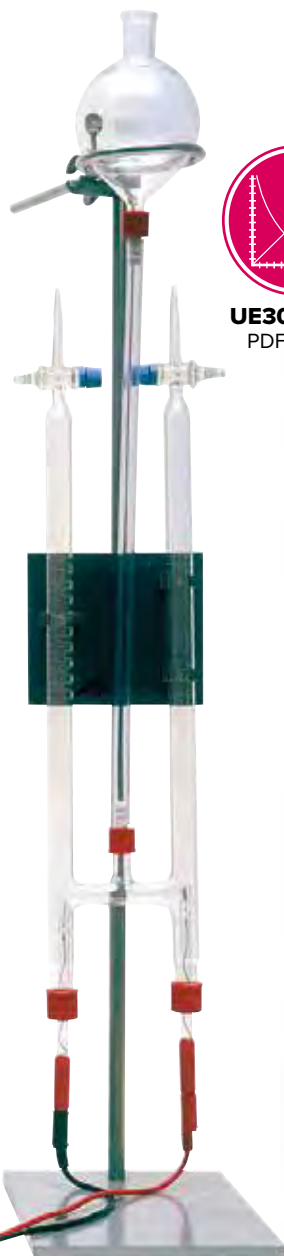

P-1002899

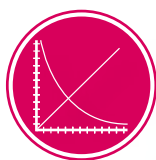

UE3020700
PDF online



P-1003507

Hofmann's Voltmeter

Apparatus for electrolysis of water, the quantitative determination of the gases formed and establishing Faraday's laws. Consists of two scaled gas collection tubes connected by flexible plastic hose with levelling bulb for pressure compensation and hence for the exact measurement of gas volumes, on stand with retaining plate. GL threads provide secure mounting for electrodes.

Dimensions: approx. 800x150 mm²
 Baseplate area: approx. 250x160 mm²
 Rod: 750 mm x 12 mm diam.
 Retaining plate: approx. 120x110 mm²

Contents:

- 1 gas collection tubes
- 2 platinum electrodes with 4 mm sockets
- 1 plastic hose with levelling bulb
- 1 stand ring for holding levelling bulb
- 1 universal bosshead
- 1 stand baseplate with rod and retaining plate

P-1002899

Additionally recommended:

P-1003312 DC Power Supply, 0 – 20 V, 0 – 5 A (230 V, 50/60 Hz)
 or
P-1003311 DC Power Supply, 0 – 20 V, 0 – 5 A (115 V, 50/60 Hz)

Daniell Cell

Galvanic cell (Daniell cell) named after John Frederic Daniell for studying the properties of an electrochemical cell. The Daniell cell consists of a cylindrical zinc and copper electrode, a clay vessel and a battery glass. Filled with cell electrolyte the Daniell cell supplies a voltage of approx. 1.1 volts. The cell is delivered empty.

Connections: 4 mm jacks
 Dimensions: approx. 105 mm x 65 mm diam.
 Suitable filling: Copper sulphate solution (CuSO₄), 10% concentration,
 Zinc sulphate solution (ZnSO₄), 10% concentration

P-1002898



P-1003508

P-1002898

Carbon Electrodes

Pair of graphite electrodes for use with the Hofmann's voltameter S (P-1003507) for the analysis of ammonia solutions, solutions of table salt or other solutions with chloride radicals.

P-1003508

Hofmann's Voltmeter S

Hofmann's voltameter is used for determining the chemical composition of water by volume. The apparatus consists of three vertical glass tubes connected to each other at the bottom. Taps at the top ends of the outside tubes are closed whilst the inner cylinder is open at the top to allow the addition of water via a reservoir. Gold sheet electrodes are fitted to the lower ends of the outside tubes and connected to a low-voltage power supply. The proportion of hydrogen and oxygen produced by electrolysis from the water can be read from the graduations on the side tubes. By opening the taps at the top of the tubes, gases can be collected for analysis. Carbon electrodes are also available for analysis of solutions where gold is unsuitable.

Dimensions: approx. 580x150 mm²
 Stand base, A-shaped: 115 mm leg length
 Operating voltage: 4 – 12 V DC

P-1003507

Additionally required:

P-1003312 DC Power Supply, 0 – 20 V, 0 – 5 A (230 V, 50/60 Hz)
 or
P-1003311 DC Power Supply, 0 – 20 V, 0 – 5 A (115 V, 50/60 Hz)

Additionally recommended:

P-1003508 Carbon electrodes

Equipment Set for Electrochemistry

Set for measuring electrochemical potentials of various metals in experiments intended for students. Includes digital multimeter.

Trough: approx. 85x70x45 mm³
 Electrodes: approx. 76x40 mm²

Contents:

- 1 flat trough
- 1 copper plate
- 1 zinc plate
- 1 iron plate
- 2 nickel plates
- 1 aluminum plate
- 2 electrolyte-carbon plates
- 1 digital multimeter with 2 cables with crocodile clamps

P-1002711



P-1002711

Electrode plates (not shown)

Spare electrodes for the electrochemistry equipment set (P-1002711).

Dimensions: approx. 76x40 mm²

Art.-No.	Material
P-1002712	Set of 10 Copper Plates
P-1002713	Set of 10 Zinc Plates
P-1002714	Set of 10 Iron Plates
P-1002715	Set of 5 Nickel Plates
P-1002716	Set of 10 Aluminum Plates
P-1002717	Set of 5 Carbon Plates

Leclanché Cell

This model of a dry battery was invented by the French chemist Georges Leclanché in the 1860s. It consists of a cylindrical zinc electrode, a rod shaped carbon electrode, a clay vessel and a battery glass. Filled with cell electrolyte, the Leclanché cell supplies a voltage of approximately 1.5 volts. The cell is delivered empty.

Connections: 4 mm jacks
 Dimensions: approx. 175 mm x 65 mm diam.

Suitable filling: Ammonium chloride solution (NH₄Cl), approx. 20% concentration

P-1002897



Experiment Topics:

- Conductors and non-conductors
- Determining electrolytes
- Distinguishing between 5 typical electrolytes

Conductivity Tester

Easy to use meter for determining conductivity of electrolytes (in water courses) and distinguishing between distilled water, rain water, tap water, brine and sea water, as well as between acids and alkalis. The display indicates the levels "very low", "low", "medium", "high" and "very high" and has LED backlighting. Even the very low conductivity of distilled water is displayed. The device is protected against spray and can therefore be used without difficulty in the open air. It can be powered either by a 9-V block battery (not included) or by the supplied 12-V/500-mA plug-in power supply.

Measuring ranges: 2 – 20 μS/cm (very low),
 20 – 100 μS/cm (low),
 100– 500 μS/cm (medium),
 500 – 3000 μS/cm (high),
 > 3000 μS/cm (very high)

Dimensions: 85x35x170 mm³
 Battery capacity: 10 hours approx.

P-1012890

Additionally required:
P-1012889 Conductivity Electrode

P-1012890



Conductivity Electrode

Conductivity electrode for use with conductivity tester (P-1012890). With platinum wires and 0.8 m of cable tipped by two 4-mm plugs.

Cell constant: 1/cm approx.
 Dimensions: 130 mm x 15 mm diam.

P-1012889

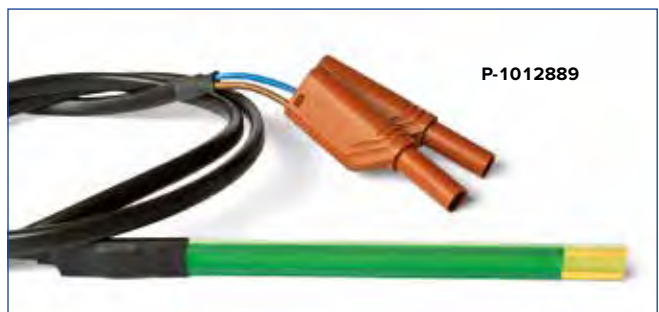

P-1012889

Magnetic Equipment Set

A selection of various magnets for introducing the subject of magnetism. Complete with a specially moulded storage tray.

Contents:

- 3 AlNiCo round magnets: 12 mm, 19 mm, 24 mm diam.
- 1 AlNiCo horseshoe magnet, 25 mm long
- 1 Chromium-steel horseshoe magnet, 100 mm long
- 2 Chromium-steel bar magnets, 100 mm x 6 mm diam.
- 2 Bar magnets in a protective plastic case, 80 mm long
- 5 Iron ring magnets, 25 mm diam.
- 5 Iron magnets, $19 \times 19 \times 5 \text{ mm}^3$
- 1 Natural magnet
- 4 Coloured magnetic foils, $50 \times 50 \text{ mm}^2$
- 2 Drawing compasses, 19 mm diam.
- 2 Drawing compasses, 16 mm diam.

P-1003089



P-1003089

Pair of Bar Magnets, 80 mm

Pair of bar magnets with poles marked red and blue. In plastic protective cover.

Dimensions: approx.
 $80 \times 22 \times 10 \text{ mm}^3$

P-1003085

Cylindrical Bar Magnet 50x20

Round bar magnet with poles marked red and green.

Dimensions: approx.
 $50 \text{ mm} \times 20 \text{ mm}$ diam.

P-1003556

Cylindrical Bar Magnet 200x10

Round bar magnet with poles marked red and green.

Dimensions: approx.
 $200 \text{ mm} \times 10 \text{ mm}$ diam.

P-1003112

Horseshoe Magnet, 70 mm

Horseshoe shaped AlNiCo magnet. Poles marked red and green.

Pole area: approx. $20 \times 10 \text{ mm}^2$
Distance between poles: approx. 50 mm
Length of shank: approx. 70 mm
Weight: approx. 400 g

P-1000929

Horseshoe Magnet 130 mm, with Yoke

Horseshoe shaped magnet with yoke. Poles coloured red/green.

Pull-off force of yoke: 250 N
Pole spacing: approx. 60 mm
Length: approx. 130 mm

P-1003114

Suspended Magnet

Apparatus for demonstrating repulsion forces between magnets. Two ring magnets facing each other with identical poles are placed onto a rod.

Base: approx. 100 mm diam.
Rod: approx. $100 \text{ mm} \times 30 \text{ mm}$ diam.
Weight: approx. 410 g

Contents:

- 1 Rod with Base
- 2 Ring magnets

P-1000943

Bar Magnet, AlNiCo, 70 mm

AlNiCo bar magnet with poles marked red and green.

Dimensions: approx. $70 \times 20 \times 8 \text{ mm}^3$
Weight: approx. 80 g

P-1003554

Pair of Bar Magnets, AlNiCo, 60 mm, with Two Iron Yokes

Pair of AlNiCo bar magnets, red, with north pole marked. Including two iron yokes.

Dimensions: approx. $60 \times 15 \times 5 \text{ mm}^3$

P-1003086

Horseshoe Magnet 140 mm, with Yoke

Horseshoe shaped stainless steel magnet with yoke, poles coloured red and silver.

Pole area: approx. $20 \times 10 \text{ mm}^2$

Distance between poles: approx. 60 mm
Length of shank: approx. 140 mm

P-1003088

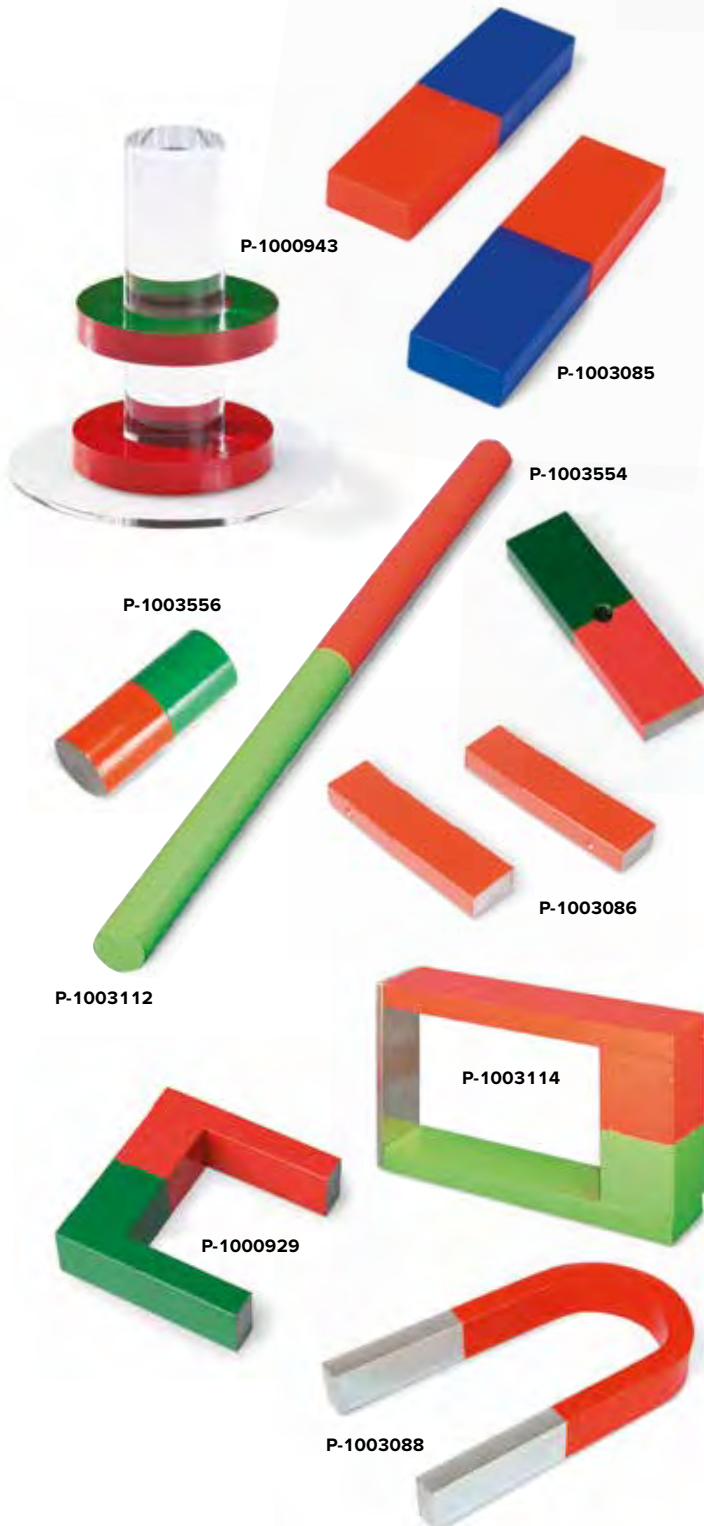

P-1000943

P-1003085

P-1003554

P-1003556

P-1003086

P-1003112

P-1003114

P-1000929

P-1003088

Equipment Kit “Hysteresis Curve”

Apparatus for recording the magnetic flux density as a function of the magnetic field strength in different samples.

Dimensions of the

- iron samples: approx. 140 mm x 10 mm diam.
- Number of turns: 850
- Internal resistance: 3.2 Ω
- Inductance without core: 3.2 mH
- Dimensions: approx. 200x145x65 mm³
- Total weight: approx. 470 g

Contents:

- Base plate with coil and holder for Hall sensors
- 3 Material samples (Vacon 11, spring steel and silver steel)

P-1018889

Additionally required:

P-1009957 Function Generator FG 100 (230 V, 50/60 Hz)

or

P-1001036 Function Generator FG 100 (115 V, 50/60 Hz)

Additionally recommended:

P-1000558 Magnetic Field Sensor 100 mT

P-1000540 3B Netlog™ (230 V, 50/60 Hz)

or

P-1000539 3B Netlog™ (115 V, 50/60 Hz)

P-1000544 3B NETlab™

Alternative:

P-1001040 Magnetic Field Sensor, Axial/Tangential

P-1008537 Teslameter E

P-1002727 Analogue Oscilloscope 2x30 MHz



P-1018889



P-1003090

Soft-Iron Bars

Set of 5, non-magnetic soft-iron bars for magnetic induction experiments.

Dimensions: approx. 155 mm x 10 mm diam.

P-1003090

Lodestone

Unfinished, walnut-sized stone made of magnetic iron ore (magnetite).



P-1003091

P-1003091

Compass Magnet with Plastic Bowl

Very powerful neodymium magnet covered with a plastic case which can float on the surface of water and faces North South when it comes to rest. Complete with translucent plastic bowl marked with compass points.

Dimensions:

Magnet: 80 mm x 30 mm max diam.

Bowl: approx. 40 mm x 115 mm diam.

P-1003096



P-1003096

“Oersted’s Needle” Device

Compact and easy to understand apparatus to demonstrate Oersted’s experiment. An electric current passing through a piece of enamelled copper wire creates a magnetic field around the wire, which can deflect a magnetic compass needle from its normal position.

Dimensions of base: 200x80 mm²

Copper wire: 3 mm diam.

Electrical

connections: 4-mm safety sockets

Maximum

permissible current: 5 A

P-1009710

Additionally recommended:

P-1003312 DC-Power Supply 0 – 20 V, 0 – 5 A (230 V, 50/60 Hz) or

P-1003311 DC-Power Supply 0 – 20 V, 0 – 5 A (115 V, 50/60 Hz)



P-1009710



P-1013123

Globe with Bar Magnet

Globe of the World with bar magnet along the axis of the Poles on an acrylic base, this demonstrates the shape of the Earth's magnetic field. A compass (P-1003093) or a magnetic field indicator (P-1003555) can be seen to align at the surface of the globe in accordance with a magnetic field parallel to the lines of longitude. The inclination can also be determined using the magnetic field sensor.

Dimensions: 220x160x200 mm³
 Diameter (globe): approx. 120 mm
 Weight: approx. 340 g

P-1013123

Additionally recommended:
P-1003555 Magnetic Field Indicator
P-1003093 Compass

Magnetic Field Indicator

Bar magnet, with Poles identified by colour and free to turn in space, for three-dimensional mapping of magnetic fields. On agate gimbal bearings pivot allowing free rotation in space, small bar magnet with colour pole coding. The handle and cardanic suspension are made of plastic to alleviate any adverse effects on magnetic field.

Magnet: approx. 25x3x3 mm³
 Handle length: approx. 95 mm

P-1003555



P-1003555

Experiment: Determination of the horizontal and vertical components of the Earth's magnetic field

- Equipment:
 P-1000906 Helmholtz Coils 300 mm
 P-1003312 DC Power Supply 0 – 20 V, 0 – 5 A (230 V, 50/60 Hz)
 or
 P-1003311 DC Power Supply 0 – 20 V, 0 – 5 A (115 V, 50/60 Hz)
 P-1002781 Digital Multimeter P1035
 P-1006799 Inclination Instrument E
 P-1003066 Rheostat P-100 Ω
 P-1002843 Set of 15 Safety Experiment Leads, 75 cm

P-1003312
 P-1003311



P-1003066

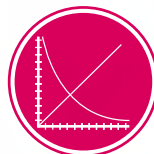

UE3030700
 PDF online



P-1002781

P-1000906



P-1006799

Determination of the horizontal and vertical components of the Earth's magnetic field

Compass

Compass in a stable housing, low friction needle bearing, including a compass card and angle scale.
Scale division: 2°
Diameter: approx. 45 mm

P-1003093

Magnetic Needle, 80 mm

Magnetic needle mounted on base with pivot point.
Length: approx. 80 mm
Height: approx. 110 mm

P-1000674



P-1003093

P-1000674

Inclination Instrument E

Instrument for measuring the inclination of the Earth's magnetic field and also for mapping the magnetic field of a current-carrying conductor. The agate bearings hold the magnetic needle which is mounted in a frame with reference circle. The frame is equipped with an additional reference circle. There are two 4 mm sockets included for the power supply.

Length of magnetic needle: approx. 100 mm
Dimensions: approx. 180x100x220 mm³
Weight: approx. 620 g

P-1006799

Additionally recommended:

P-1003312 DC Power Supply 0 – 20 V, 0 – 5 A (230 V, 50/60 Hz)

or

P-1003311 DC Power Supply 0 – 20 V, 0 – 5 A (115 V, 50/60 Hz)



P-1006799

Inclination Instrument

Instrument for measuring the inclination of the Earth's magnetic field and also for mapping the magnetic field of a current-carrying conductor. An aluminium conductor loop with 4 mm safety sockets, a magnetic needle with a pointed axle rotates on bearings above a full circle in transparent material with an angle scale, rotating around the horizontal axis and mounted on an acrylic base.

Diameter of circle: approx. 110 mm
Length of magnetic needle: approx. 100 mm
Strap length: approx. 150 mm
Terminal: 4 mm safety sockets
Base dimensions: approx. 100x90x185 mm³

P-1003192

Additionally recommended:

P-1003312 DC Power Supply 0 – 20 V, 0 – 5 A (230 V, 50/60 Hz)

or

P-1003311 DC Power Supply 0 – 20 V, 0 – 5 A (115 V, 50/60 Hz)



P-1003192

Set of 10 Tracing Compasses

Set of 10 compasses for tracing field lines. Aluminium housing, glazed on both sides. Markings for indicating compass directions.

Diameter: approx. 19 mm

P-1003095



P-1003095



P-1009765

Three-Dimensional Magnetic Field Lines Device

Instrument for three-dimensional mapping of the magnetic field lines of a cylindrical bar magnet. The acrylic housing is filled with a special, highly viscous liquid and iron filings. After the magnet has been inserted into the central hole, the iron filings, which had previously been distributed randomly in the liquid, align themselves according to the direction of the field. An enclosed air bubble ensures that a good shake of the device causes the iron shavings to be evenly distributed.
 Diameter of the hole: approx. 21 mm
 Dimensions: approx. 120x110x110 mm³
 Weight: approx. 0.8 kg

P-1009765

Additionally required:
P-1003556 Cylindrical Bar Magnet 50x20 mm



P-1000580

P-1000581

Two-Dimensional Magnetic Field Line Apparatus

Demonstration apparatus for two-dimensional display of magnetic field lines in combination with an overhead projector. It consists of a transparent plastic vessel filled with a liquid containing magnetic powder. Magnets and an experiment manual in English are included.
 Dimensions: approx. 220x120x10 mm³

P-1003092

Additionally required:
Overhead projector



P-1003092

Hexagonal Magnet Model

Demonstration apparatus for the properties of the crystal lattice of ferromagnetic materials, particularly Weiss domains, Barkhausen jumps, saturation, hysteresis and Curie temperature. 117 freely moving magnetic needles are supported in a hexagonal arrangement between two connected transparent acrylic plates. For projection on the overhead projector.

Length of magnetic needles: approx. 17 mm
 Dimensions of plate: approx. 150x150 mm²

P-1002975

Additionally recommended:
Overhead projector
P-1000942 Pair of Flat Coils

Magnet Model, Cubic

Like P-1002975, but with magnets in a square arrangement.

P-1002976

Additionally recommended:
Overhead projector
P-1000942 Pair of Flat Coils

Iron Filings

250 g of iron filings for displaying magnetic field lines. In a storage flask.

P-1000580

Additionally recommended:
P-1000581 Shaker

Shaker

Plastic flask with a fine hole for scattering iron filings evenly.

P-1000581

Pair of Flat Coils

Pair of coils for generating a near-uniform magnetic field for the hexagonal and cubic magnet models (P-1002975 and P-1002976). This makes it possible to observe changes in the magnetic flux when the magnetisation is changed.

Number of turns: 125
 Resistance: 7 Ω approx.
 Permitted current: 1 A
 Dimensions: 150x30x18 mm³ approx.
 Weight: 85 g approx.

P-1000942

Additionally recommended:
P-1003312 DC-Power-Supply 0 – 20 V, 0 – 5 A (230 V, 50/60 Hz)
 or
P-1003311 DC-Power-Supply 0 – 20 V, 0 – 5 A (115 V, 50/60 Hz)



P-1002976

P-1002975



P-1000942

Experiment Topics:

- Magnetic flux lines of bar and horseshoe magnets
- Magnetic screening
- Magnetic induction
- To display the shapes adopted by magnetic field lines around a straight conductor, a conductor loop, a cylindrical coil, and an electromagnet

Set of Apparatus for Displaying Magnetic Fields

Equipment set for demonstration experiments designed to make visible the magnetic field distribution of permanent magnets and current carrying conductors. Also compatible for use with a daylight projector. The acrylic glass boxes containing iron filings are equipped with a pouring lip so that the used fillings can easily be refilled into the storage bottle.

Acrylic glass boxes: approx. 185x125x40 mm³
 Storage tray: approx. 430x380x25 mm³
 Weight: approx. 1.5 kg

Contents:

- 1 Straight conductor mounted on box made of transparent acrylic
- 1 Ring-shaped conductor mounted on box made of transparent acrylic
- 1 Cylindrical coil mounted on box made of transparent acrylic
- 1 Magnetic overlay with guide studs on acrylic box
- 1 Acrylic plastic box with smooth surface for scattering materials
- 2 Soft iron bars
- 1 Flat soft iron bar
- 2 Permanent flat bar magnets
- 1 Soft iron ring
- 1 Magnetic needle with holder
- 1 Scattering bottle with iron filings
- 1 Pre-molded storage tray

P-1000925

Additionally required:

P-1002771 DC-Power Supply, 0 – 16 V, 0 – 20 A
 (115/230 V, 50/60 Hz)

Additionally recommended:

Overhead Projector

Current Conductor on Acrylic Base

Current Conductor for demonstrating the magnetic fields of current-carrying conductors. The magnetic field can be made visible with iron powder. Acrylic glass base with two 4 mm safety sockets. For projection on the overhead projector.

Dimensions of

acrylic glass base: approx. 185x150x30 mm³

Straight Conductor on Acrylic Base

P-1000926

Loop-Shaped Conductor on Acrylic Base

P-1000927

Coil on Acrylic Base

Number of turns: 7
 Coil diameter: approx. 35 mm
 Coil length: approx. 65 mm

P-1000928

Additionally required:

P-1002771 DC-Power Supply, 0 – 16 V, 0 – 20 A
 (115/230 V, 50/60 Hz)

P-1000580 Iron Filings

P-1000581 Shaker



P-1000925

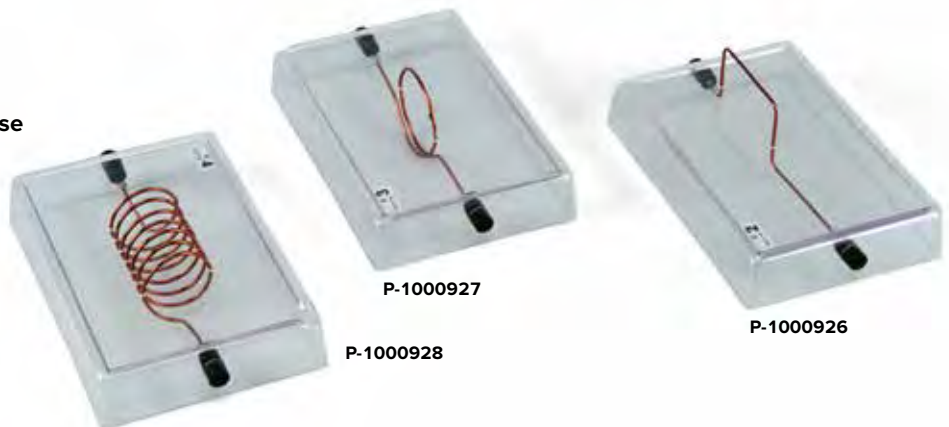

P-1000927

P-1000928

P-1000926

Pair of Helmholtz Coils on Mounting Plate

Pair of coils with variable separation for determining the optimum Helmholtz configuration and for quantitative testing of the uniformity of the magnetic field. The apparatus comprises a pair of coils arranged parallel to each other, mounted on a robust metal base plate with a holder for a magnetic field meter to measure the magnetic field. One coil and its holder are moveable. There are two scales printed on the base plate to allow coil separation to be read off and to determine how far the measurement probe's position deviates laterally from the coil axis respectively.

- Average coil diameter: 125 mm
- Number of turns: 100 each
- Max. coil separation: 240 mm
- Max. permissible current: 5 A
- Terminals: 4 mm safety sockets
- Base plate: approx. 400x200 mm²

P-1003193

Additionally recommended:
P-1000558 Magnetic Field Sensor

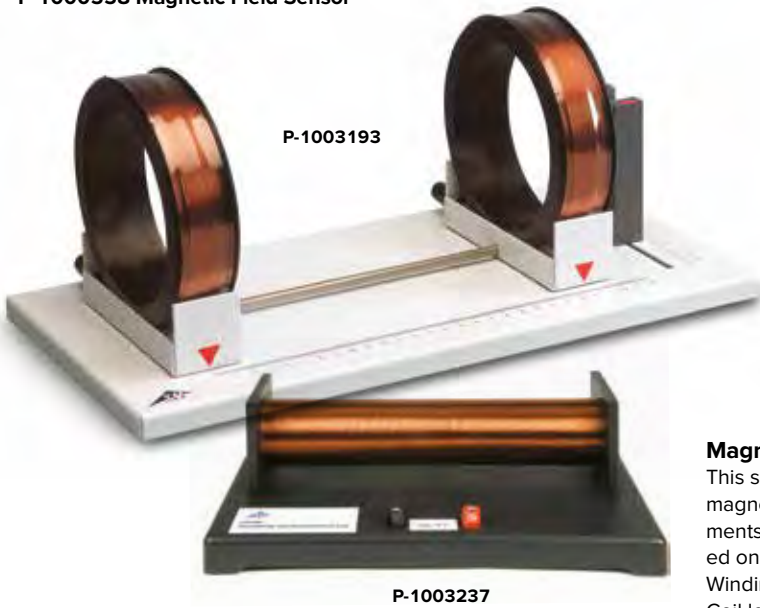

Coil with Variable Number of Turns per Unit Length

Cylindrical coil of variable length for investigating the magnetic field strength as a function of the closeness of the turns.

- Coil diameter: 100 mm
- Number of turns: 30
- Coil length: 490 mm
- Max. Current: 10 A, for short periods 20 A
- Terminal: 4 mm safety sockets

P-1000965

Additionally recommended:
P-1000964 Stand for Cylindrical Coils
P-1000558 Magnetic Field Sensor



Field Coils

Cylindrical coils for experiments investigating magnetic field intensity as a function of the current and the number of turns, for demonstrating that the field intensity is independent of the coil cross section.

- Coil bobbins made of acrylic.
- Number of turns: 120
- Coil length: 490 mm
- Max. current: 10 A, for short periods 20 A
- Terminal: 4 mm safety sockets

Field Coil 100 mm diam.

P-1000591

Field Coil 120 mm diam.

P-1000592

Additionally recommended:
P-1000964 Stand for Cylindrical Coils
P-1000558 Magnetic Field Sensor

Magnetising Coil

This solenoid allows you to magnetise and demagnetise ordinary magnets or iron bars in addition to conducting inductance experiments. The rugged unit consists of insulated copper winding, mounted on a base with 4mm sockets and a switch.

- Windings: 1000
- Coil length: 250 mm
- Coil radius: 35 mm internal
- Operating Voltage: max. 12 V DC or 12 V AC
- Dimensions: 305x200x100 mm³
- Mass: 2 kg

P-1003237

Stand for Cylindrical Coils

- Made of acrylic.
- Dimensions: approx. 165x120x75 mm³
- Weight: approx. 185 g

P-1000964

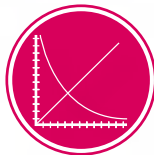

UE3030500
 PDF online

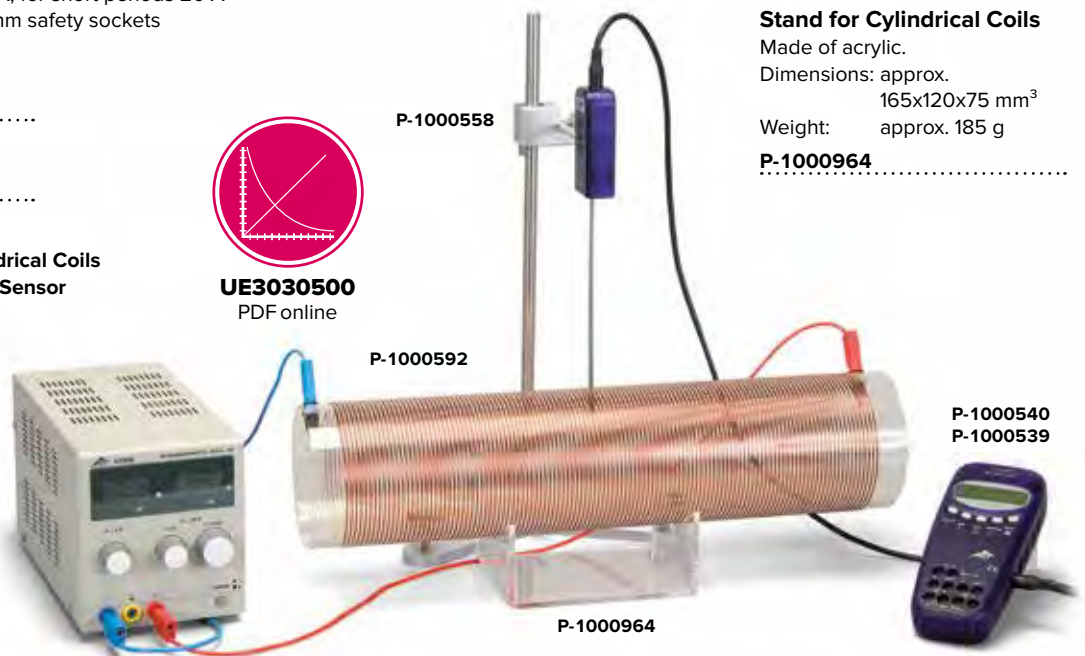

Measurement of the magnetic field around a current carrying coil

Determining the Helmholtz Configuration: Measurement of Magnetic Field for a Pair of Coils with Variable Separation

Description	Art. No.
Pair of Helmholtz Coils on Mounting Plate	P-1003193
Teslameter 200 mT (230 V, 50/60 Hz)	P-1003314
or	
Teslameter 200 mT (115 V, 50/60 Hz)	P-1003313
DC Power Supply 0 – 20 V, 0 – 5 A (230 V, 50/60 Hz)	P-1003312
or	
DC Power Supply 0 – 20 V, 0 – 5 A (115 V, 50/60 Hz)	P-1003311
Digital Multimeter P3340	P-1002785
Pair of Safety Experiment Leads, 75 cm	P-1002849



Measurement of Magnetic Field for a Pair of Coils with Variable Separation

Magnetic Fields



Holder for Magnetic Field Sensor (not shown)
Holder on a stem to accommodate magnetic field sensor in experiments to confirm the Biot-Savart law.

P-1019212

Set of Four Conductors for Biot-Savart Experiments

Equipment set comprising a straight conductor and three circular ones for experimental investigation of how magnetic flux density is calculated according to the Biot-Savart law.

- Connectors: 4-mm plug
- Maximum continuous current: 20 A
- Diameter of circular conductors: 120 mm, 80 mm and 40 mm
- Length of straight conductor: 400 mm

P-1018478

Additionally recommended:

- P-1018449** Holder for Plug-in Components
- P-1019212** Holder for Magnetic Field Sensor
- P-1012892** Flexible Magnetic Field Sensor
- or
- P-1001040** Magnetic Field Sensor, Axial/Tangential
- P-1008537** Teslameter E
- P-1003040** Optical Bench U, 600 mm
- P-1003041** Optical Rider U, 75 mm (2x)
- P-1002771** DC Power Supply 0 – 16 V, 0 – 20 A
- P-1002849** Pair of Safety Experiment Leads, 75 cm

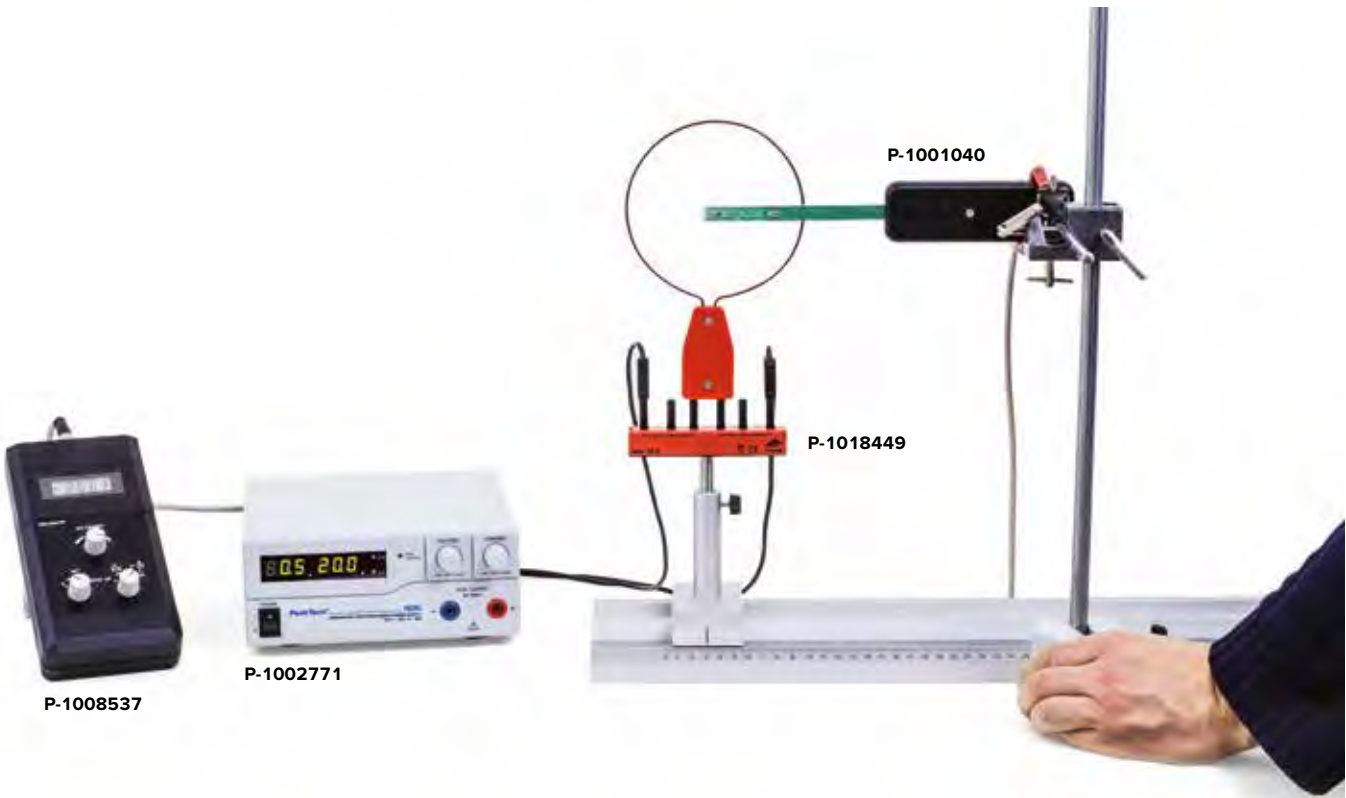

Electricity and Magnetism

Current Balance Equipment Set

Equipment set for measuring force on a current-carrying conductor in a magnetic field as a function of the current, of the magnetic field or of the length of the conductor. The force is composed of the apparent change in the weight of the holder for the permanent magnets, which is measured by means of a sensitive set of scales.

Max. current: 5 A
 Weight: 500 g approx.

Contents:

- Conductor, 1 cm
- Conductor, 2 cm
- Conductor, 4 cm
- Conductor, 8 cm
- Holder for permanent magnets
- 6 Permanent magnets
- Folding power feed and holder for conductors

P-1019188

Additionally required:

- P-1002933 Steel Rod 25 cm**
- P-1002835 Tripod Stand, 150 mm**
- P-1002850 Pair of Experiment Leads**
- P-1009772 Electronic Scale 200 g, 0,01 g (230 V, 50/60 Hz)**
- P-1003312 DC Power Supply 0 – 20 V, 0 – 5 A (230 V, 50/60 Hz)**
or
- P-1003311 DC Power Supply 0 – 20 V, 0 – 5 A (115 V, 50/60 Hz)**

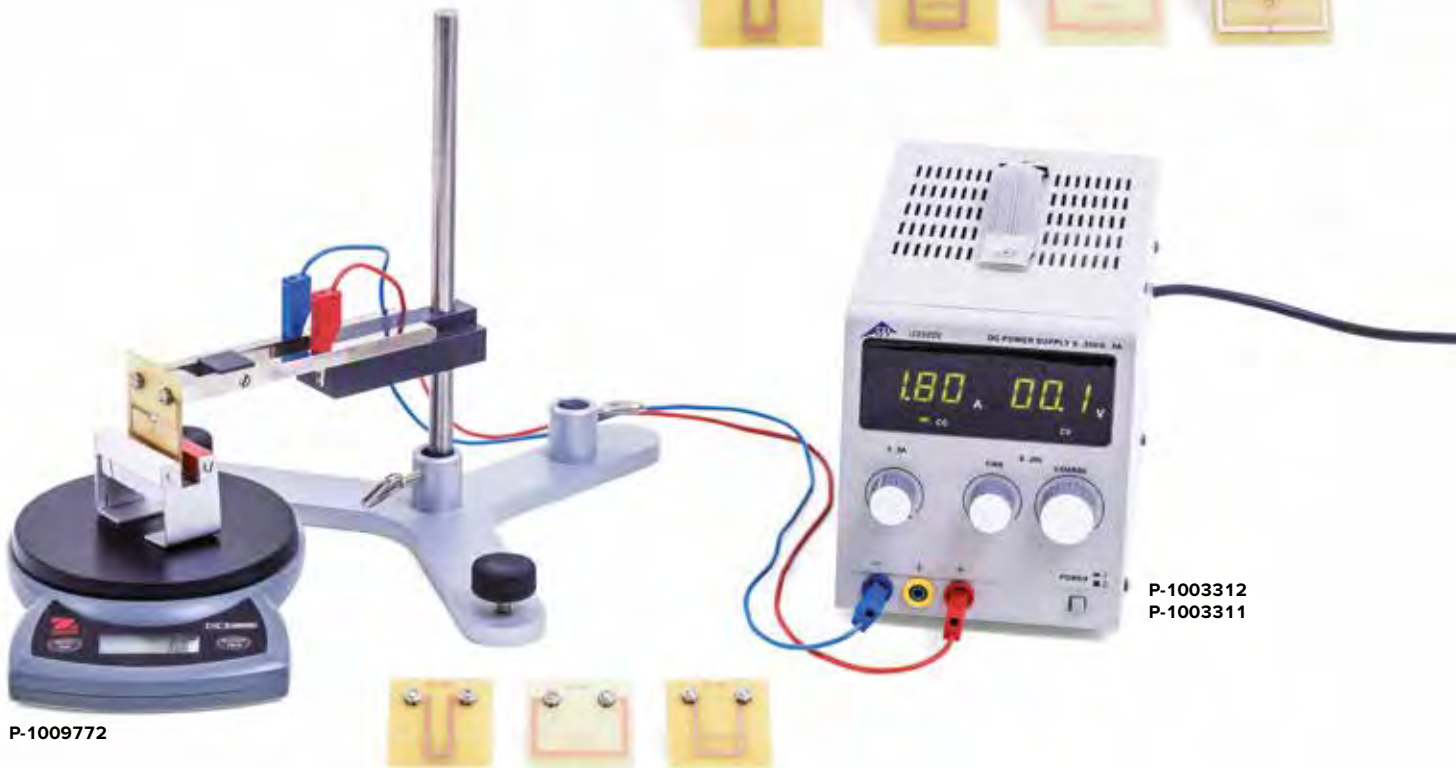

P-1009772

P-1003312
P-1003311



P-1003251

Lorentz Force Apparatus

The apparatus consists of a powerful U shaped magnet, a pair of brass rails complete with 4mm sockets and a brass axle. A power supply unit is connected to the rails. When the axle is placed on the rails the electric circuit is completed and the axle is repelled along the rails in a direction either towards or away from the magnetic field. Reversing the current will have the opposite effect.

Dimensions: 175x65x70 mm³

P-1003251

Additionally required:

- P-1003312 DC Power Supply 0 – 20 V, 0 – 5 A (230 V, 50/60 Hz)**
or
- P-1003311 DC Power Supply 0 – 20 V, 0 – 5 A (115 V, 50/60 Hz)**

Experiment Topics

- Diamagnetism and paramagnetism
- Waltenhofen's pendulum
- Force on a conductor in a magnetic field in parallel and transverse configurations
- Measuring currents with a current balance



UE3030300
PDF online

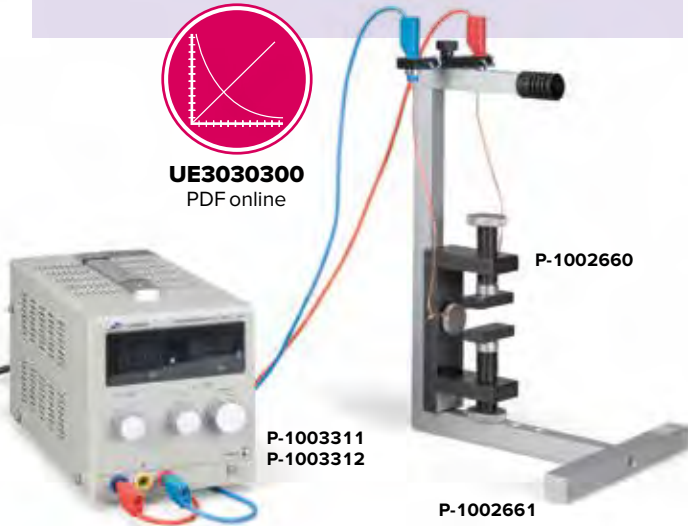

Equipment Set Electromagnetism

This equipment consists of a stable, firm, anodised-aluminium tripod with pre-defined magnet positions and accessory mountings. The deflection of the conductor swing can be adjusted in steps of 0, 15, 30 and 45 mm for current balance experiments.

Contents:

- 1 Aluminium tripod, anodised
- 1 Conductor swing with 4 mm safety jacks
- 2 Waltenhofen pendulums (solid and slotted)
- 1 Glass rod and polyester thread with hook

Lorentz Motor

Comprising a motor armature without an iron core, this device is intended for installation inside the permanent magnet with adjustable pole spacing (P-1002660). The coil is rotated purely by the Lorentz force, its direction of rotation depending on the direction of the current.

P-1002662

Additionally required:

- P-1002660 Permanent Magnet with Adjustable Pole Spacing**
- P-1003312 DC Power Supply 0 – 20 V, 0 – 5 A (230 V, 50/60 Hz)**
- or
- P-1003311 DC Power Supply 0 – 20 V, 0 – 5 A (115 V, 50/60 Hz)**



- 1 Aluminium rod and polyester thread with hook
- 1 Knurled screw

P-1002661

Additionally required:

- P-1002660 Permanent Magnet with Adjustable Pole Spacing**
- P-1003312 DC Power Supply 0 – 20 V, 0 – 5 A (230 V, 50/60 Hz)**
- or
- P-1003311 DC Power Supply 0 – 20 V, 0 – 5 A (115 V, 50/60 Hz)**

Permanent Magnet with Adjustable Pole Spacing

This permanent magnet has an adjustable pole spacing and a high field strength arising from the use of two neodymium magnet elements. It comes with a black-finished iron yoke, knurled handles made of high-grade steel and attachable pole shoes. This magnet system can be installed horizontally or vertically.

- Magnet: 20x10 mm²
- Pole shoes: 20x50 mm²
- Pole spacing: 2 – 80 mm
- Field strength at centre of gap: 20 mT – 1000 mT

P-1002660

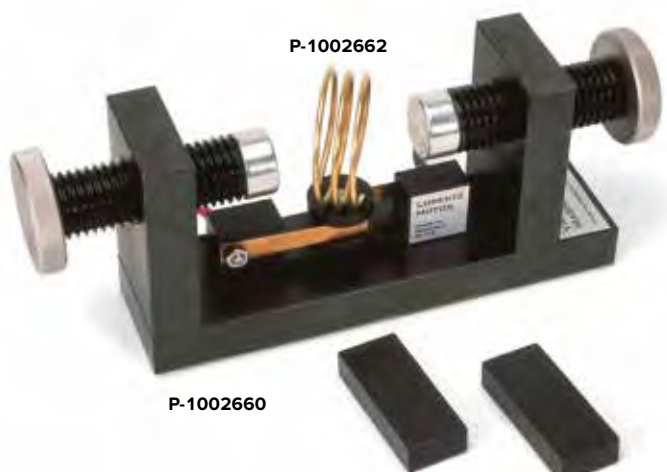

Electric Motor and Generator, Complete

Functioning model for demonstration of how a DC motor, as well as DC and AC generators, work. The model is equipped with a commutator, slip ring, pick-ups and armature coil and is mounted on a transparent acrylic plate with connection sockets, drive pulley and rubber drive belt. Includes horseshoe magnet, 70 mm.

Dimensions: approx. 130x150 mm²
 Weight: approx. 850 g

P-1017801



Operating as an AC generator



P-1017801



Operating as a DC generator

Induction Apparatus

Apparatus for demonstrating the induced voltage in a frame coil that is moved through the magnetic field produced by a magnet plate of limited area or by the rotation of a current-carrying conductor in the magnetic field of the magnet plate. By varying the speed of motion of the frame coil, the direction of motion and the number of turns in the coil, the induction law can be derived experimentally and quantitatively. The transparent design of the magnetic plate and coils means that they can be demonstrated on the overhead projector. An unfoldable support permits inclined set-up.

Operating voltage: 2–12 V DC
 Frame coil: approx. 185x125 mm²
 Total dimensions: approx. 585x200x55 mm³
 Weight: approx. 3 kg

Contents:

- 1 Induction apparatus with retractable magnetic plate
- 1 Frame coil
- 1 Rolling conductor loop

P-1000968

Additionally required:

P-1003312 DC-Power Supply Unit 0 – 20 V, 0 – 5 A (230 V, 50/60 Hz)

or

P-1003311 DC-Power Supply Unit 0 – 20 V, 0 – 5 A (115 V, 50/60 Hz)

P-1003073 Analogue Multimeter AM50

Additionally recommended:
Overhead Projector

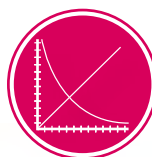

UE304020
 PDF online

P-1003312
P-1003311



P-1003073

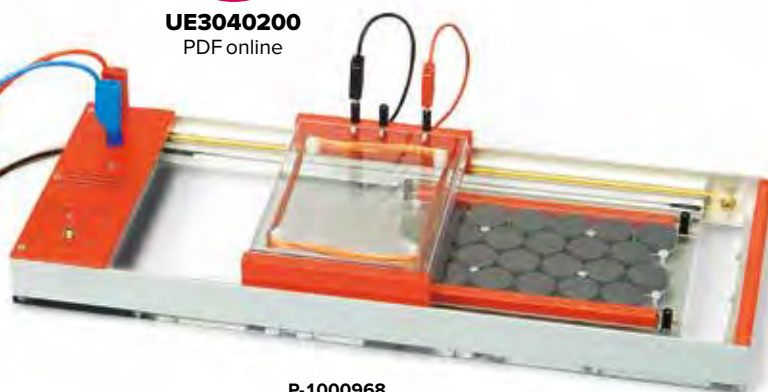

P-1000968

Flat Coil in a Rotatable Frame

Flat coil in a plexiglas frame, mounted so that it can be rotated, for use in combination with 300 mm Helmholtz coils (P-1000906). When the flat coil is rotated in the magnetic field of the Helmholtz coils, an alternating voltage is induced. The electrical connection to the coil is established via sliding contacts. A hand crank and pulley on the rotary frame's axle are used to drive the coil.

Number of turns: 4000
 Effective area: 42 cm²
 Dimensions: approx. 110x80x11 mm³
 Weight: approx. 360 g

P-1013131

Additionally required:

- P-1000906 Helmholtz Coils, 300 mm
 - P-1003073 Analogue Multimeter AM50
 - P-1003312 DC-Power Supply Unit 0 – 20 V, 0 – 5 A (230 V, 50/60 Hz)
- or
- P-1003311 DC-Power Supply Unit 0 – 20 V, 0 – 5 A (115 V, 50/60 Hz)



Helmholtz Coils 300 mm

Pair of coils with large diameter in Helmholtz configuration used to produce a homogeneous magnetic field. The coils can be switched in parallel or in series. A spring clip on the top crossbar is used to mount the Hall sensor during measurements of the magnetic field.

Coil diameter: approx. 300 mm
 Number of turns per coil: 124 each
 DC resistance: 1.2 Ω each
 Maximum coil current: 5 A each
 Terminals: 4 mm safety sockets
 Weight: 4.1 kg approx.
 Max. field: 3.8 mT

P-1000906

Additionally recommended:

- P-1000558 Magnetic Field Sensor



Tube with Six Induction Coils

Plastic tube with six identical induction coils connected in series. When the bar magnet provided is allowed to fall through the tube, a voltage is induced in each of the coils in turn. As the velocity of the magnet increases with time during its fall, the amplitudes of the voltage peaks also increase, and their width decreases. The area under each voltage peak remains constant.

Coil width: 10 mm
 Distance between coils: 190 mm
 Dimensions: approx. 1500 mm x 20 mm diam.
 Weight: approx. 500 g

P-1001005

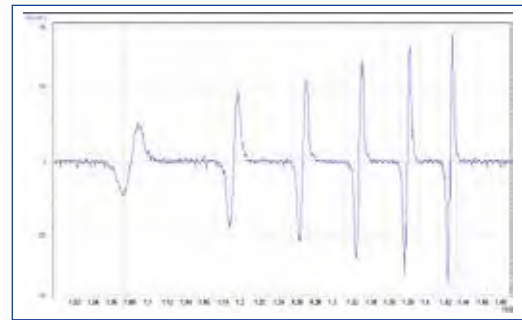

The induced voltage as a function of time

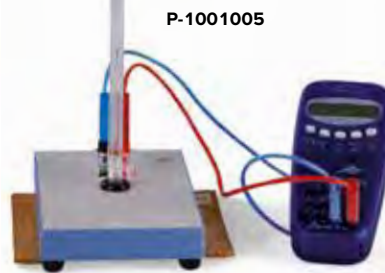

P-1001005

- P-1000540
- P-1000539

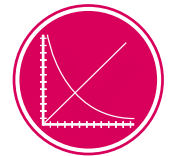

UE3040100
 PDF online

Demonstration Dynamo

This model dynamo demonstrates the conversion of mechanical energy into electrical energy. All working parts of the electric motor are clearly visible. The motor is mounted on a base plate and coupled by a rubber belt to a hand-drive pulley. External connection is via 4 mm sockets with a light emitting diode acting as an output indicator. The magnetic field is provided by a permanent magnet.

Base plate: 200x100x20 mm³
 Hand-drive pulley: 150 mm diam.
 Height: 180 mm

Contents:

- 1 Apparatus on base plate
- 1 Removable magnet
- 1 Stackable light emitting diode
- 1 Small dynamo pulley

P-1003252



P-1003252



UE3040400
PDF online



Waltenhofen's Pendulum

Equipment set for the demonstration of the effects of eddy currents and braking. A pendulum object composed of a solid steel plate swings back and forth between the poles of an electromagnet with the power switched off. When the magnet is switched on, the pendulum motion of the object comes to an almost immediate halt. If the plate contains slots more time elapses before the plate stops moving, i.e. the braking effect is severely reduced. The equipment set consists of a pendulum rod and four aluminium pendulum plates with various shapes: rectangle, rectangle with slits, circular disk, ring and ring with slits.

Rectangular: approx. 100x60 mm²
Ring: approx. 30 mm diam. (interior),
approx. 60 mm diam. (exterior)

P-1000993

Additionally required:

P-1000976 Transformer Core D

P-1000978 Pair of Pole Pieces

P-1000989 Coil with 1200 Turns (2x)

P-1003312 DC-Power Supply 0 – 20 V, 0 – 5 A (230 V, 50/60 Hz)

or

P-1003311 DC-Power Supply 0 – 20 V, 0 – 5 A (115 V, 50/60 Hz)



Set of 3 Induction Coils

Coils for experiments on induction in combination with the 120 mm diameter field coil (P-1000592) and for experiments on resonant electric circuits. The coils are only designed for safety extra low voltage (SELV). The spools are made of transparent acrylic plastic.

Connection: 4 mm safety sockets
Coil length: 170 mm

Coil 1

Number of turns: 300 with taps at 100 and 200 turns
Coil cross section: 50x50 mm²

Coil 2

Number of turns: 300
Coil cross section: 50x30 mm²

Coil 3

Number of turns: 300
Coil cross section: 50x20 mm²

P-1000590

Additionally recommended:

P-1000592 Field Coil 120 mm diam.



Variable Inductance Coil

Coils for measuring inductance and self-inductance of a current-carrying coil depending on the insertion of an iron core and for investigating AC circuits. Coil of copper wire in a shock-resistant plastic casing with lifting handles. A coated iron core is mounted on a worm screw for moving in and out of the coil. With printed scale in cm for reading the length of core inserted into the coil.

Number of windings: 3000
Max. permissible voltage: 30 V AC, 60 V DC
Max. permissible current: 2 A

Inductance at 1 A: approx. 0.15 – 1.4 H, continuously adjustable
Resistance: 12.5 Ω

Terminals: 4 mm safety plugs
Dimensions: approx. 265x145x130 mm³
Weight: approx. 6.2 kg

P-1003194



Lenz's Law Copper Tube

Handy demonstration apparatus for illustrating Lenz's law and induction of eddy currents. A small steel cylinder and a magnet of the same dimensions fall at different speeds through a copper tube because the motion of the magnet causes eddy currents to be induced, resulting in a magnetic field which slows the fall of the magnet. Includes 2 plastic caps so that the tube can be used as a container.

Length: 320 mm approx.
Diameter: 15 mm approx.

P-1009716



P-1009716

Lenz's Law Apparatus

Instrument for demonstrating Lenz's Law qualitatively by bringing a magnet close to it. One closed and one open conductor loop, with point bearing on base.

Length: approx. 195 mm
Height: approx. 110 mm

P-1009959

Additionally required:

P-1003112 Cylindrical Bar Magnet 200x10



P-1009959

Bicycle Dynamo, Transparent

Bicycle dynamo in transparent housing. It is possible to observe the movement of the generator components while the dynamo is in operation.

Generated voltage: 6 V approx.
Generated power: 3 W
Dimensions: 95x34x25 mm³ approx.

P-1010164



P-1010164

Experiment Motor with Gearbox

Experiment motor for universal use in experiments on rotational motion, e.g. for experiments using Watt's governor (P-1009695). Can also be used as a generator in conjunction with the included hand crank. Robust clockwise and counter-clockwise rotating IDC motor with epicyclic gearbox and quick-action chuck in a tough anodized aluminum casing with removable and adjustable stainless steel stand rod. Can also be mounted on the clamp for the projectile launcher (P-1002655). Speed of rotation is adjusted by altering the supply voltage. Adjustable torque. Includes 3 belt pulleys of different diameters on a mounting axle.

Speed without load: approx. 480 rpm at 12 V
Speed sensitivity: approx. 40 rpm per V
Span of chuck: 0.8 to 10 mm
Stand rod: 12 mm diam.
Pulleys: 10 mm diam., 20 mm diam., 40 mm diam.
Axle: 10 mm diam.
Drive belt: 130 mm diam. x 4 mm
Nominal voltage: 12 V DC, 5A
Connection: via 4-mm safety sockets
Dimensions: 210x95x60 mm³
Mass: 1.2 kg

Contents:

- Experiment motor
- Stand rod with knurled screws
- Hand crank
- Pulleys
- Drive belt

P-1002663



P-1002663



Additionally required:

P-1003312 DC Power Supply 0 – 20 V, 5 A (230 V, 50/60 Hz)

or

P-1003311 DC Power Supply 0 – 20 V, 5 A (115 V, 50/60 Hz)

Additionally recommended:

P-1003331 Digital Stroboscope (230 V, 50/60 Hz)

or

P-1003330 Digital Stroboscope (115 V, 50/60 Hz)



Experiment topics:

- Voltage transformation
- Transformer under load
- Current transformation
- Autotransformer
- Leakage field experiments
- Induction oven
- Point welding
- Fusing experiments
- High voltage experiments



P-1000976,
P-1000987/P-1000986,
P-1000985

Transformer Core D

U shaped core made of high grade laminated transformer plates, with removable yoke. Provided with two clips for securing the yoke or attaching special pole shoes with drilled holes (P-1000978).

Cross-section of core: 40x40 mm²

U-core: approx. 150x130 mm²

Length of yoke: approx. 150 mm

Weight: approx. 6 kg

P-1000976**High Voltage Coil D including 2 Horn Shaped Electrodes**

Secondary coil for transformer core D (P-1000976), generating high voltages which can cause spark discharges between two shielded horn electrodes. Covered with impact resistant plastic, safe to touch.

Number of turns: 24000

Open-circuit voltage: approx. 9200 V

Resistance: 10 k Ω

Max. current: 0.02 A

Inductance: 28 H

P-1000991

Additionally required:

P-1000976 Transformer Core D

P-1000987 Mains Coil D with Connecting Lead (230 V, 50/60 Hz)
or

P-1000986 Mains Coil D with Connecting Lead (115 V, 50/60 Hz)

High Current Coil D for Nail Fusing Experiment

Secondary coil for use with the transformer core D (P-1000976) to generate a large current sufficient to melt nails. Covered by impact resistant plastic.

Number of turns: 6

Resistance: 3 m Ω

Max. current: 60 A

Inductance: 0.25 mH

P-1000984

P-1000987

P-1000986

P-1000985

P-1000984

	P-1000987	P-1000986
Description	Mains Coil D with Connecting Lead (230 V, 50/60 Hz)	Mains Coil D with Connecting Lead (115 V, 50/60 Hz)
Number of turns	600	300
Resistance	3 Ω	0.75 Ω
Max. current	2.2 A	4.4 A
Inductance	15 mH	7.5 mH

Primary or Secondary Coils for Transformer Core D

Coils, covered with impact resistant plastic so that they are safe to touch, for use as primary or secondary coils in combination with transformer core D (P-1000976). With safety connection sockets. As secondary coils these can output either low or high voltage, depending on the primary voltage, and therefore they cannot be used in student experiments.

	P-1000988	P-1000989	P-1000990
Number of turns	600	1200	6000
Taps	200/600	400/1200	2000/6000
Resistance	3 Ω	12 Ω	300 Ω
Max. current	2.2 A	1.2 A	0.2 A
Inductance	15 mH	60 mH	1.5 H

Low Voltage Coil D

Secondary coil for use with a transformer core D (P-1000976) to generate low voltages up to 24 V. With five tapping points. Covered by impact resistant plastic, safe to touch.

Terminals: Safety sockets

Number of turns: 72

Taps: 6/ 30/ 54/ 66/ 72

Resistance: 0.1 Ω

Max. current: 12 A

Inductance: 0.23 mH

P-1000985

Additionally required:

P-1000976 Transformer Core D

P-1000987 Mains Coil D with Connecting Lead (230 V, 50/60 Hz)

or

P-1000986 Mains Coil D with Connecting Lead (115 V, 50/60 Hz)

Mains Coil D with Connecting Lead

Coil that is safe to touch with mains connecting lead for use as primary coil in combination with the transformer core D (P-1000976). Covered by impact resistant plastic, safe to touch.

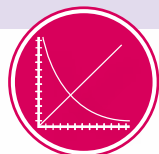

UE3040500
PDF online

P-1000991

P-1000988

P-1000990

P-1000989



P-1012859

Coil D, 900 Turns

Coil with 900 turns and thermal overload protection. For generating powerful magnetic fields in conjunction with the U-core (P-1000979).

Number of turns: 900
 Inductance: approx. 34 mH
 Resistance: approx. 4.8 Ω (at room temperature)
 approx. 6.0 Ω (at maximum amperage)

Maximum permissible amperage: 5 A (for approx. 7 minutes)
 Waiting time for reactivation after thermal overload: approx. 10 minutes
 Weight: approx. 1.6 kg

P-1012859

High Current Coil with Five Turns

Secondary coil for transformer core D (P-1000976), generating high voltages which can be used for spot-welding of metal sheets up to 2 mm thick.

Number of turns: 5
 Short-circuit current: approx. 260 A
 Coil diameter: 57 mm
 Weight: approx. 650 g

P-1000981

Additionally required:

P-1000982 Set of Metal Strips

P-1000976 Transformer Core D

P-1000987 Mains Coil with Connecting Lead (230 V, 50/60 Hz)

or

P-1000986 Mains Coil with Connecting Lead (115 V, 50/60 Hz)



P-1000981

Set of Metal Strips

Five metal strips used to demonstrate spot welding techniques in conjunction with a coil with 5 turns (P-1000981).

Dimensions: 120x10 mm²

P-1000982



P-1000982

Set of 20 Nails for Nail Fusing Experiment

20 nails for experiments involving fusing using high current coil (P-1000984).

P-1000983

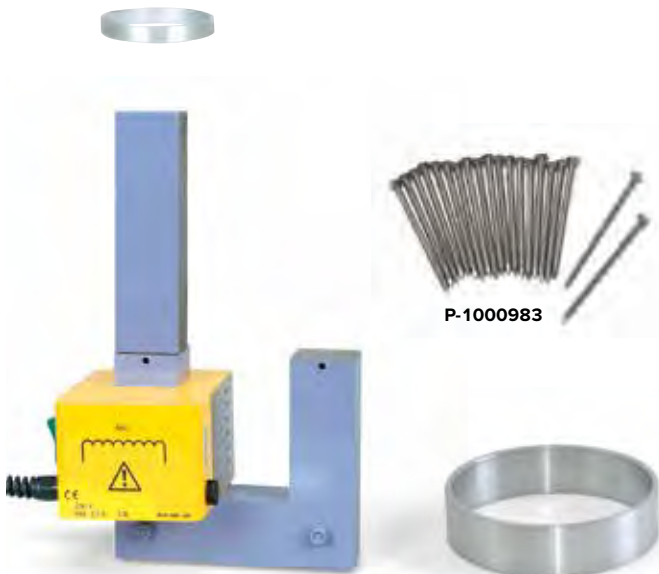

P-1000992

Metal Ring

Metal ring for performing Thomson's ring experiment in conjunction with the mains coil (P-1000987 resp. P-1000986) and the transformer core D (P-1000976). First the metal ring is fitted around one stem of a U core and allowed to rest on the mains coil. The stem of the U core is extended by the yoke positioned vertically on top of it. When the mains coil is switched on the ring jumps into the air.

Diameter: 55 mm

P-1000992

Additionally required:

P-1000976 Transformer Core D

P-1000987 Mains Coil with Connecting Lead (230 V, 50/60 Hz)

or

P-1000986 Mains Coil with Connecting Lead (115 V, 50/60 Hz)



P-1000980

Fusion Ring

Circular aluminium channel with insulated handle for demonstrating the principle of induction melting, when used as a secondary coil with the transformer core D (P-1000976).

Max. current: approx 1300 A
 Internal diameter: approx. 57 mm
 Weight: approx. 80 g

Suitable melting materials:

Wood's Alloy, Tin

P-1000980

Additionally required:

P-1000976 Transformer Core D

P-1000987 Mains Coil with Connecting Lead (230 V, 50/60 Hz)

or

P-1000986 Mains Coil with Connecting Lead (115 V, 50/60 Hz)



P-1008525



P-1000979

Pair of Clamps D

Pair of clamps from the transformer core D (P-1000976).

P-1000977



P-1000978

P-1000977

Pair of Pole Shoes D

Pair of pole shoes with conical ends for generating a highly non uniform magnetic field when fitted onto the U core D (P-1000979). Provided with holes for optical experiments in a magnetic field.

Pole shoe: approx. 40x40 mm²

Weight: approx. 1.7 kg

P-1000978

Pole Shoe Fitting D

Pole shoe fitting with adjustable separation for generating a uniform magnetic field on a U-shaped core D (P-1000979). Includes two 20-mm spacers, four 10 mm spacers and four 5 mm spacers.

Dimensions: 150x120x40 mm

Weight: 5.7 kg

P-1008525

U Core D

U shaped transformer core D (P-1000976).

P-1000979

Pair of Pole Shoes and Clamping Brackets D for Hall Effect

Pair of pole pieces for experiments on the semiconductor Hall effect. Including clamping brackets for mounting on the U-core D (P-1000979).

Pole shoe dimensions: 40x40x75 mm³

Total weight: approx. 2 kg

P-1009935

Experiment topics:

- Voltage transformation
- Transformer under load
- Current transformation
- Autotransformer
- Leakage field experiments
- Fusing experiments

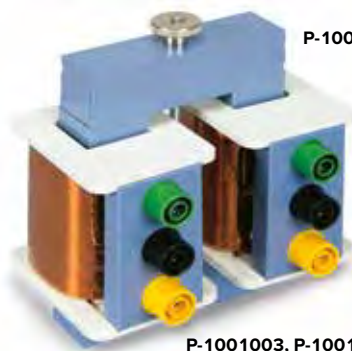

P-1001004

Transformer Core S

U-core with removable yoke made of high quality transformer laminate.

Core cross section: 20x20 mm approx.

U-core: 70x70 mm approx.

Length of yoke: 70 mm approx.

P-1001004

P-1001003, P-1001000

High Current Coil S

Secondary coil for transformer core S (P-1001004) for generating high current output.

No. of windings: 22

Max. Current: 10 A

P-1000999



P-1001000-P-1001003



P-1000999

Transformer Coils S

Impact resistant plastic covered coils, safe to touch, for assembling a transformer in conjunction with the transformer core S (P-1001004).

Maximum voltage: 50 V (safety extra-low voltage)

Terminals: 4 mm safety sockets

Opening for iron

cores: approx. 20x20 mm²

Art. No.	Number of turns	Max. current	Inductance
P-1001000	600	800 mA	approx. 6 mH
P-1001001	800	600 mA	approx. 10 mH
P-1001002	1200	400 mA	approx. 25 mH
P-1001003	2400	200 mA	approx. 100 mH

Experiment Topics:

- Hertzian waves (high frequency electromagnetic waves)
- Absorption and transmission
- Corona discharge
- Spark discharge
- Wireless transmission of energy to a fluorescent lamp
- Standing waves on a Tesla coil

Tesla Transformer

Classic Tesla transformer for the generation of a safe high frequency high voltage starting from approx. 100 kV. The well-conceived, open configuration of all components facilitating demonstration of both design and function. The apparatus is rendered shock proof on account of its extra low voltage operation.

No. of turns in the primary coil:	2 – 10
No. of turns in the secondary coils:	1150
Primary voltage:	20 V AC
Secondary voltage:	>100 kV
Transformer:	approx. 330x200x120 mm ³
Secondary coils:	approx. 240 mm x 75 mm diam.
Weight:	approx. 3 kg

Contents:

- 1 Tesla transformer, basic apparatus
- 1 Hand coil
- 1 Secondary coil
- 1 Spherical electrode, short
- 1 Spherical electrode, long
- 1 Needle electrode with spray wheel
- 1 Fluorescent tube
- 1 Reflector

P-1000966

Additionally required:

P-1003593 AC/DC Power Supply 0 – 30 V, 6 A (230 V, 50/60 Hz) or

P-1008692 AC/DC Power Supply 0 – 30 V, 6 A (115 V, 50/60 Hz)

Additionally recommended:

P-1000967 Additional Coil for Tesla Transformer

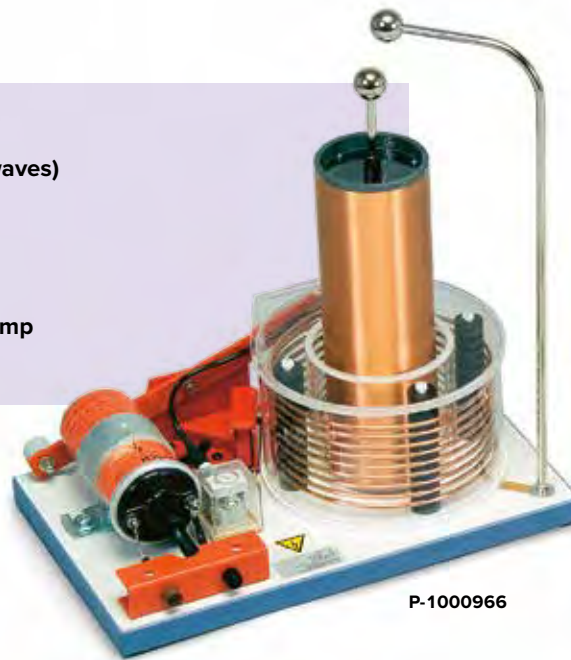

P-1000966



Additional Coil for Tesla Transformer

Additional secondary coil for Tesla transformer (P-1000966). Dimensions: approx. 240 mm x 75 mm diam.

P-1000967



P-1000967



P-1003593
P-1008692

AC/DC Power Supply, 0 – 30 V, 0 – 6 A

Combined power supply with separate AC and DC outputs plus separate displays of output voltage and current. The DC output can be used as a voltage source or current source and can be set to any value within its range. The AC output features current limiting and is electronically protected against overload.

DC voltage:	0 – 30 V
DC current:	0 – 6 A
AC voltage:	0 – 30 V
AC current:	max. 6 A
Dimensions:	380x140x300 mm ³ approx.
Weight:	12 kg approx.

AC/DC Power Supply, 0 – 30 V, 0 – 6 A (230 V, 50/60 Hz)

P-1003593

AC/DC Power Supply, 0 – 30 V, 0 – 6 A (115 V, 50/60 Hz)

P-1008692

Important Note:

Los aparatos used in training, teaching and research establishments which are designed for the investigation of electromagnetic phenomena is permitted to exceed the limits for interference emissions specified in the EMC directive. The interference generated by this apparatus is in excess of the permitted limits for interference emission according to the applicable EMC standards and could adversely affect the functionality of other electronic equipment in the building and its environment.

Users are responsible for the reduction and avoidance of such adverse effects and are expected to take the necessary precautions if any interference should occur which causes problems.

Experiment topics:

- Thermionic emission of electrons
- Linear propagation of electrons in field free spaces
- Deflection in magnetic and electric fields
- Determination of the polarity of electron charges
- Determination of specific charge e/m
- Inelastic electron collisions
- Luminescence
- Wave and particle nature of electrons

TELTRON® Electron Tubes D

Known throughout the world, tried and trusted over many years: Electron tubes with thermionic cathodes for experimental investigations of the properties of the free electron.

- Thermionic emission of electrons
- Linear propagation of electrons in field free spaces
- Deflection in magnetic and electric fields
- Determination of the polarity of electron charges
- Determination of specific charge e/m
- Inelastic electron collisions
- Luminescence
- Wave and particle nature of electrons

There is no need to take precautions against ionising radiation, since it is not necessary to use a high voltage of more than 5 kV to operate the tubes.

Electron Diffraction Tube D

Highly evacuated electron tube for demonstrating the wave nature of electrons through the observation of interference caused by passage of electrons through a polycrystalline graphite lattice (Debye-Scherrer diffraction) and rendered visible on a fluorescent screen. Also intended for determining the wavelength as a function of the anode voltage from the radii of the diffraction rings and the lattice plane spacing of graphite, as well as confirming de Broglie's hypothesis.

Filament voltage: 6.3 V AC
 Max. anode voltage: 5000 V
 Anode current: approx. 0.1 mA at 4000 V
 Focussing voltage: 0 – 50 V
 Lattice constant of graphite: $d_{10} = 0.213$ nm, $d_{11} = 0.123$ nm

P-1013885

Additionally required:

P-1008507 Tube Holder D

P-1002847 Set of Leads for Electron Tube Experiments

P-1003310 High Voltage Power Supply, 5 kV
(230 V, 50/60 Hz) or

P-1003309 High Voltage Power Supply, 5 kV
(115 V, 50/60 Hz)

Additionally recommended:

P-1009960 Three-Pole Protective Adaptor

Note:

When using just one high-voltage power supply, the anode voltage and capacitor voltage cannot be selected independently of one another.

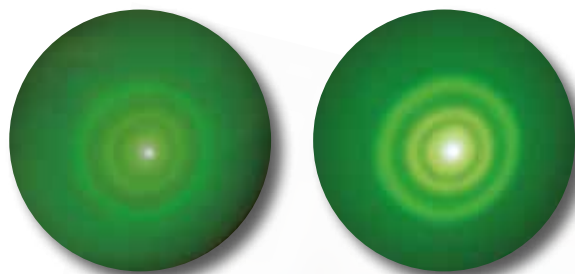

Recording in a darkened room with 3 kV and 4,5 kV.



P-1013885

Electron Deflection Tube D

Highly evacuated electron tube with focusing electron gun and fluorescent screen inclined relative to the beam axis, so that the path of the beam can be seen and the effects of electric and magnetic fields can be studied. The electron beam can be deflected electrically in the electric field of the built-in plate capacitor, and magnetically by using the Helmholtz pair of coils D (P-1000644). By adjusting the electric field so that it cancels the magnetic deflection, it is possible to determine the specific charge e/m and the velocity of the electrons.

Filament voltage: 6.3 V AC
 Max. anode voltage: 5000 V
 Anode current: approx. 0.1 mA at 4000 V
 Max. capacitor voltage: 5000 V
 Fluorescent screen: approx. 90x60 mm²
 Glass bulb: approx. 130 mm diam.
 Total length: approx. 260 mm

P-1000651

Additionally required:

P-1008507 Tube Holder D

P-1002847 Set of Leads for Electron Tube Experiments

P-1000644 Helmholtz Pair of Coils D

P-1003310 High Voltage Power Supply, 5 kV
(230 V, 50/60 Hz) (2x)

P-1003312 DC-Power Supply 0 – 20 V, 0 – 5 A
(230 V, 50/60 Hz) or

P-1003309 High Voltage Power Supply, 5 kV
(115 V, 50/60 Hz) (2x)

P-1003311 DC-Power Supply 0 – 20 V, 0 – 5 A
(115 V, 50/60 Hz)

Additionally recommended:

P-1009961 Two-Pole Protective Adaptor





P-1000650

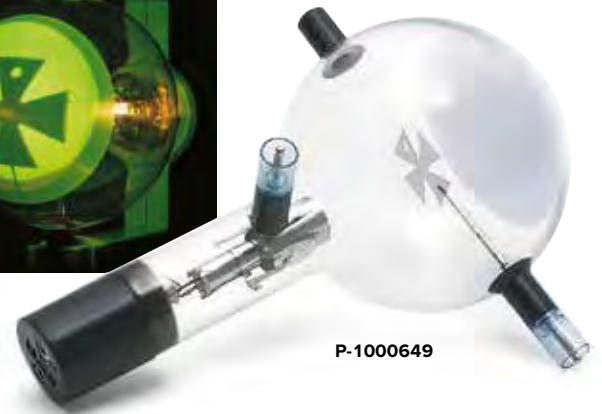

P-1000649

Perrin Tube D

Highly evacuated electron tube with focusing electron gun, fluorescent screen, and Faraday cage positioned on one side. For demonstrating the negative polarity of electrons and estimating the specific electron charge (charge-to-mass ratio) e/m by magnetic deflection into the Faraday cage, which is connected to an electroscope (P-1003048). It is also possible to investigate the deflection of electrons by two magnetic fields at right-angles to each other and to demonstrate the effects, for example by generating Lissajou figures.

Filament voltage: 6.3 V AC
 Max. anode voltage: 5000 V
 Anode current: approx. 0.1 mA at 4000 V
 Beam current: 4 μ A at 4000V
 Glass bulb: approx. 130 mm diam.
 Luminescent screen: 85 mm diam.
 Total length: approx. 250 mm

P-1000650

Additionally required:

- P-1008507 Tube Holder D
- P-1002847 Set of Leads for Electron Tube Experiments
- P-1000644 Helmholtz Pair of Coils D
- P-1003310 High Voltage Power Supply, 5 kV (230 V, 50/60 Hz)
- P-1003312 DC-Power Supply 0 – 20 V, 0 – 5 A (230 V, 50/60 Hz) or
- P-1003309 High Voltage Power Supply, 5 kV (115 V, 50/60 Hz)
- P-1003311 DC-Power Supply 0 – 20 V, 0 – 5 A (115 V, 50/60 Hz)

Additionally recommended:

- P-1003048 Electroscope
- P-1000645 Auxiliary Coil
- P-1009961 Two-Pole Protective Adaptor

Luminescence Tube D

Highly evacuated electron tube with divergent electron gun and three fluorescent strips in red, green and blue. For demonstrating stimulated light emission during and after electron bombardment.

Filament voltage: 6.3 V AC
 Max. anode voltage: 5000 V
 Anode current: approx. 0.1 mA at 4000 V
 Glass bulb: approx. 130 mm diam.
 Total length: approx. 260 mm

P-1000648

Additionally required:

- P-1008507 Tube Holder D
- P-1002847 Set of Leads for Electron Tube Experiments
- P-1003310 High Voltage Power Supply, 5 kV (230 V, 50/60 Hz) or
- P-1003309 High Voltage Power Supply, 5 kV (115 V, 50/60 Hz)

Additionally recommended:

- P-1009961 Two-Pole Protective Adaptor

Maltese-Cross Tube D

Highly evacuated electron tube with divergent electron gun, fluorescent screen and Maltese cross. For demonstrating the straight line propagation of electrons in the absence of any electric or magnetic field by projecting the shadow of a Maltese cross onto the fluorescent screen and for introducing students to electron optics.

Filament voltage: 6.3 V AC
 Max. anode voltage: 5000 V
 Anode current: approx. 0.1 mA at 4000 V
 Glass bulb: approx. 130 mm diam.
 Luminescent screen: 85 mm diam.
 Total length: approx. 260 mm

P-1000649

Additionally required:

- P-1008507 Tube Holder D
- P-1002847 Set of Leads for Electron Tube Experiments
- P-1003310 High Voltage Power Supply, 5 kV (230 V, 50/60 Hz) or
- P-1003309 High Voltage Power Supply, 5 kV (115 V, 50/60 Hz)

Additionally recommended:

- P-1009961 Two-Pole Protective Adaptor
- P-1000644 Helmholtz Pair of Coils D
- P-1003312 DC-Power Supply 0 – 20 V, 0 – 5 A (230 V, 50/60 Hz) or
- P-1003311 DC-Power Supply 0 – 20 V, 0 – 5 A (115 V, 50/60 Hz)



P-1000648

**Triode D**

Highly evacuated electron tube with thermionic cathode, control grid and anode for quantitative investigation of controllable high vacuum tubes, plotting the characteristics of a triode, demonstrating the negative polarity of the electron charge, studying the practical applications of a triode as an amplifier and generating undamped oscillations in LC circuits.

Max. heater voltage: 7.5 V AC/DC

Max. anode voltage: 500 V

Anode current: approx. 2 mA at 200 V anode voltage

Glass bulb: approx. 130 mm diam.

Total length: approx. 260 mm

P-1000647

Additionally required:

P-1008507 Tube Holder D

P-1002847 Set of Leads for Electron Tube Experiments

P-1003073 Analogue Multimeter AM50

P-1003308 DC Power Supply, 0 – 500 V (230 V, 50/60 Hz)

or

P-1003307 DC Power Supply, 0 – 500 V (115 V, 50/60 Hz)

Additionally recommended:

P-1009961 Two-Pole Protective Adaptor

Gas Triode D

Electron tube filled with low pressure helium gas, with thermionic cathode, control grid, and anode for quantitative investigations of the typical properties of a gas-filled triode, recording the $I_A - U_A$ characteristics of a thyatron, observing independent and dependent discharges as well as discontinuous energy release of He atoms during inelastic collisions with free electrons.

Max. heater voltage: 7.5 V AC/DC

Max. anode voltage: 500 V

Anode current: approx. 10 mA at 200 V anode voltage

Glass bulb: approx. 130 mm diam.

Total length: approx. 260 mm

P-1000653

Additionally required:

P-1008507 Tube Holder D

P-1002847 Set of Leads for Electron Tube Experiments

P-1003073 Analogue Multimeter AM50

P-1003308 DC Power Supply, 0 – 500 V (230 V, 50/60 Hz)

or

P-1003307 DC Power Supply, 0 – 500 V (115 V, 50/60 Hz)

Additionally recommended:

P-1009961 Two-Pole Protective Adaptor

**Diode D**

Highly evacuated electron tube with thermionic cathode and anode for investigating the thermoelectric effect (Edison effect) and measuring the emission current as a function of the heating power applied to the cathode. Also for plotting diode characteristics and for demonstrating the rectifying effect of a diode.

Max. heater voltage: 7.5 V AC/DC

Max. anode voltage: 500 V

Anode current: approx. 2 mA at 200 V Anode voltage

Glass bulb: approx. 130 mm diam.

Total length: approx. 260 mm

P-1000646

Additionally required:

P-1008507 Tube Holder D

P-1002847 Set of Leads for Electron Tube Experiments

P-1003073 Analogue Multimeter AM50

P-1003308 DC Power Supply, 0 – 500 V (230 V, 50/60 Hz)

or

P-1003307 DC Power Supply, 0 – 500 V (115 V, 50/60 Hz)

Additionally recommended:

P-1009961 Two-Pole Protective Adaptor

		P-1000646	P-1000647	P-1000653
		Diode D	Triode D	Gas Triode D
P-1008507	Tube Holder D	required	required	required
P-1002847	Set of Leads for Electron Tube Experiments	required	required	required
P-1003308 or P-1003307	Power Supply, 500 V DC	required	required	required
P-1003310 or P-1003309	High Voltage Power Supply, 5 kV	–	–	–
P-1000644	Helmholtz Pair of Coils D	–	–	–
P-1003312 or P-1003311	DC-Power Supply 20 V	–	–	–
P-1003073	Analogue Multimeter AM50	required	required	required
P-1009961	Two-Pole Protective Adaptor	recommended	recommended	recommended
P-1009960	Three-Pole Protective Adaptor	–	–	–
P-1000645	Auxiliary Coil	–	–	–
P-1003048	Electroscope	–	–	–

Dual Beam Tube D

Part evacuated electron tube, filled with helium at low pressure, with tangential and axial electron gun. For determining specific charge e/m from the diameter of the filament beam in the case of tangential bombardment and a perpendicularly aligned magnetic field, and observing spiral paths of electrons in the case of axial bombardment and a co-axial magnetic field. The electron paths are rendered visible in the form of fine luminescent beams through impact excitation of the helium atoms.

- Max. filament voltage: 7.5 V
- Max. anode voltage: 100 V DC
- Anode current: approx. 30 mA
- Max. deflection voltage: 50 V DC
- Glass bulb: approx. 130 mm diam.
- Total length: approx. 260 mm

P-1000654

Additionally required:

- P-1008507 Tube Holder D**
 - P-1002847 Set of Leads for Electron Tube Experiments**
 - P-1000644 Helmholtz Pair of Coils D**
 - P-1003308 DC Power Supply, 0 – 500 V (230 V, 50/60 Hz)**
- or
- P-1003307 DC Power Supply, 0 – 500 V (115 V, 50/60 Hz)**

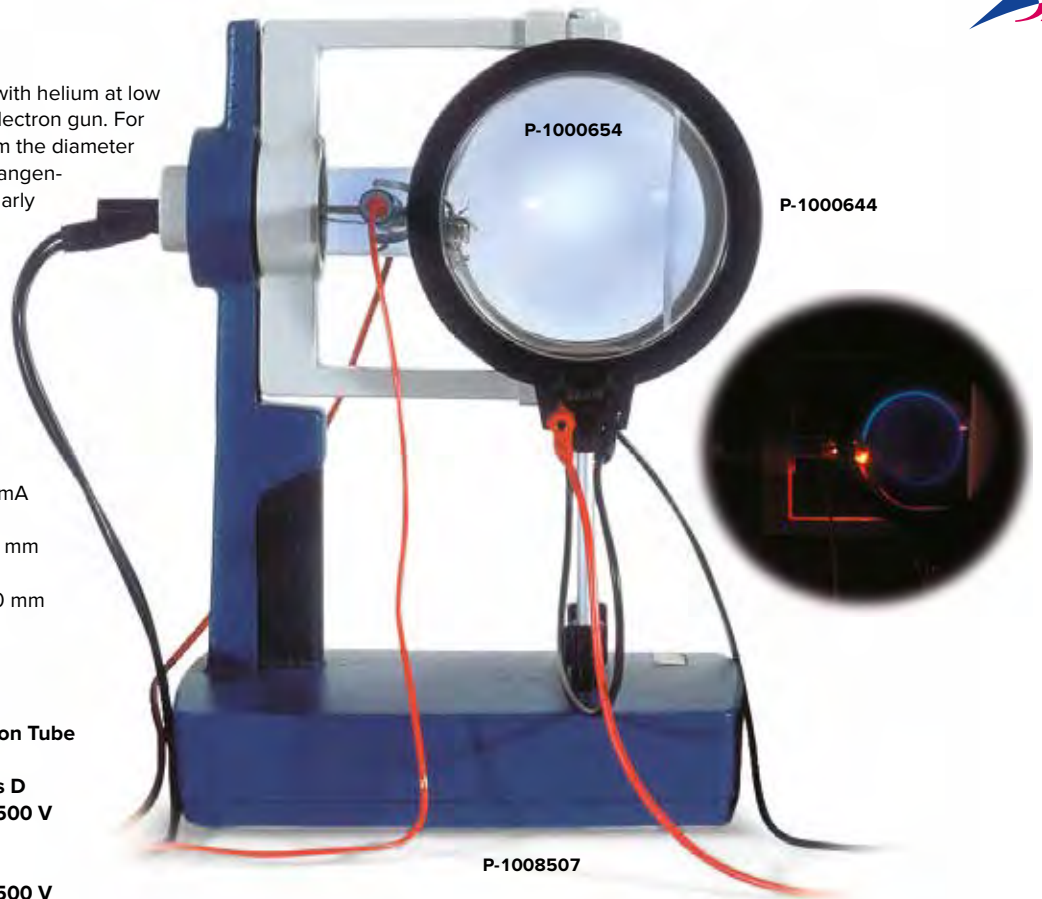

Free Electrons in Gases and in Vacuum

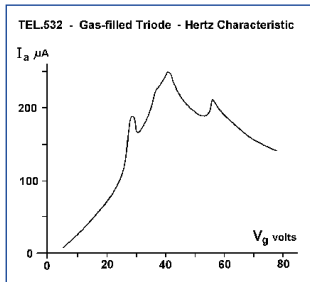

P-1000653:
Anode current I_A as a function of the anode voltage U_A at different grid voltages U_G

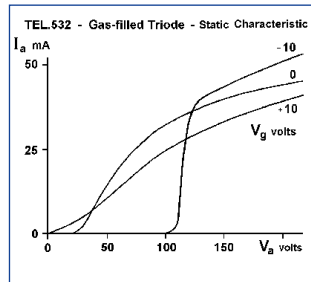

P-1000653:
Electron collision excitation in Helium as a function of the acceleration voltage U_G

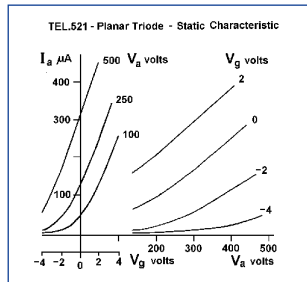

P-1000647:
Anode current I_A as a function of the grid voltage U_G and as a function of the anode voltage U_A at different grid voltage U_G

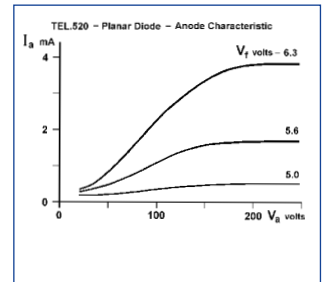

P-1000646:
Anode current I_A as a function of the anode voltage U_A

Electricity and Magnetism

P-1000654	P-1000648	P-1000649	P-1000650	P-1000651	P-1013885
Dual Beam Tube D	Luminescence Tube D	Maltese Cross Tube D	Perrin Tube D	Electron Deflection Tube D	Electron Diffraction Tube D
required	required	required	required	required	required
required	required	required	required	required	required
required	–	–	–	–	–
–	required	required	required	2x required	required
required	–	recommended	required	required	–
–	–	recommended	required	required	–
–	–	–	–	–	–
–	recommended	recommended	recommended	recommended	–
–	–	–	–	–	recommended
–	–	–	recommended	–	–
–	–	–	recommended	–	–



P-1008507

Tube Holder D

Tube holder made of robust plastic for holding electron tubes of the D series and the optical equivalent (P-1000656). With 360° rotating clamp made of heat-resistant plastic and two holes for fixing the Helmholtz coil pair D (P-1000644).

On rubber feet to prevent slipping.

Dimensions: approx. 230x175x320 mm³

Weight: approx. 1.5 kg

P-1008507

Auxiliary Coil

Extra coil for generating an additional magnetic field in a Perrin tube, for example, to demonstrate the principle of an oscilloscope and for generating Lissajou's figures.

Number of turns: 1000

DC resistance: approx. 7 Ω

Load rating: max. 2 A

Connections: 4 mm jacks

Dimensions: approx. 33 mm x 80 mm diam.

P-1000645

Optical Equivalent to Debye-Scherrer Interference

Aluminium disc with ball bearing mounted optical lattice grating for illustrating the principle of Debye-Scherrer interference using visible light. The rotating lattice grating serves as a model for the polycrystalline graphite lattice in the electron diffraction tube. Includes an aperture and red and green colour filters.

Cross lattice: 20 grid points/mm, 3 mm diam.

Flywheel: 100 mm diam.

Pinhole aperture: 1 mm dia.

Aperture frame: approx. 50x50 mm²

Filter: approx. 80x100 mm²

P-1000656

Additionally recommended:

P-1008507 Tube Holder D

P-1003188 Optical Lamp

P-1000593 Transformer 12 V, 60 VA (230 V, 50/60 Hz)

or

P-1006780 Transformer 12 V, 60 VA (115 V, 50/60 Hz)

P-1003023 Convex Lens, f = 100 mm

P-1000855 Object Holder on Stem

P-1000608 Projection Screen

P-1002835 Tripod Base

P-1001046 Barrel Foot (3x)

Protective Adaptor, 3-Pole

Adaptor for electron diffraction tube D (P-1013885) for connection of the heater voltage via safety experiment leads. Includes internal protective circuitry to protect the heating filament against excess voltage. Dimensions match the three-pole connector for the tube.

P-1009960

Protective Adaptor, 2-Pole

Adaptor for electron tubes D for connection of the heater voltage via safety experiment leads. Includes internal protective circuitry to protect the heating filament against excess voltage. Dimensions match the two-pole connector for the tubes.

P-1009961



P-1000645

P-1000644

Helmholtz Pair of Coils D

Pair of coils for generating a uniform magnetic field perpendicular to the axis of a tube when using the tube holder D (P-1008507).

In plastic sleeve on an insulated stand rod.

Coil diameter: 136 mm

Number of turns: 320 each

Effective resistance: approx. 6.5 Ω each

Load rating: 1.5 A each

Terminals: 4 mm sockets

Rod: approx. 145 mm x 8 mm diam.

P-1000644

Additionally recommended:

P-1003312 DC-Power Supply 0 – 20 V, 0 – 5 A (230 V, 50/60 Hz)

or

P-1003311 DC-Power Supply 0 – 20 V, 0 – 5 A (115 V, 50/60 Hz)



P-1000656

Experiment topics:

- Thermionic emission of electrons
- Linear propagation of electrons in field free spaces
- Deflection in magnetic and electric fields
- Determination of the polarity of electron charges
- Determination of specific charge e/m
- Luminescence
- Excitation spectra of noble gases
- Inelastic electron collisions
- Resolution of primary and secondary quantum numbers of atomic excitation levels
- Wave and particle nature of electrons

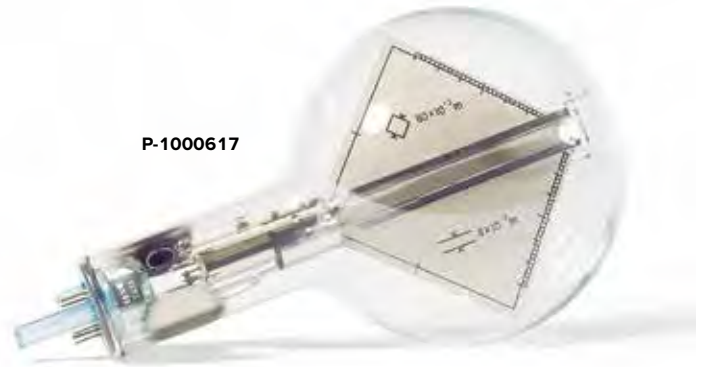

P-1000617

Thomson Tube S

Highly evacuated electron tube with focusing electron gun and fluorescent screen inclined relative to the beam axis, so that the path of the beam can be seen and the effects of electric and magnetic fields can be studied. The electron beam can be deflected electrically in the electric field of the built-in plate capacitor, and magnetically by using the Helmholtz coil pair S (P-1000611). By adjusting the electric field so that it cancels the magnetic deflection, it is possible to determine the specific charge e/m and the velocity of the electrons.

Filament voltage:	6.3 V AC
Max. anode voltage:	5000 V
Anode current:	approx. 0.1 mA at 4000 V
Max. Capacitor voltage:	500 V
Glass bulb:	approx. 130 mm diam.
Total length:	approx. 250 mm

P-1000617

Additionally required:

- P-1014525 Tube Holder S
- P-1002843 Set of 15 Safety Experiment Leads, 75 cm
- P-1000611 Helmholtz Pair of Coils S
- P-1003310 High Voltage Power Supply, 5 kV (230 V, 50/60 Hz)
- P-1003308 Power Supply, 500 V DC (230 V, 50/60 Hz)
- or
- P-1003309 High Voltage Power Supply, 5 kV (115 V, 50/60 Hz)
- P-1003307 Power Supply, 500 V DC (115 V, 50/60 Hz)

TELTRON® Electron Tubes S

Known throughout the world, tried and trusted over many years: Electron tubes with thermionic cathodes for experimental investigations of the properties of the free electron.

- Thermionic emission of electrons
- Linear propagation of electrons in field free spaces
- Deflection in magnetic and electric fields
- Determination of the polarity of electron charges
- Determination of specific charge e/m
- Luminescence
- Excitation spectra of noble gases
- Inelastic electron collisions
- Resolution of primary and secondary quantum numbers of atomic excitation levels
- Wave and particle nature of electrons

There is no need to take precautions against ionising radiation, since it is not necessary to use a high voltage of more than 5 kV to operate the tubes

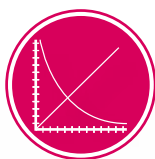

UE3070500
PDF online



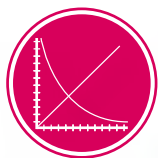

UE3070300
PDF online



P-1000011



P-1000616

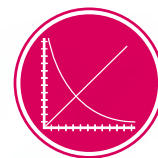

UE3070400
PDF online



Maltese Cross Tube S

Highly evacuated electron tube with divergent electron gun, fluorescent screen and Maltese cross. For demonstrating the straight line propagation of electrons in the absence of any electric or magnetic field by projecting the shadow of a Maltese cross onto the fluorescent screen and for introducing students to electron optics.

- Filament voltage: 6.3 V AC
- Max. anode voltage: 5000 V
- Anode current: approx. 0.1 mA at 4000 V
- Glass bulb: approx. 130 mm diam.
- Luminescent screen: approx. 85 mm diam.
- Total length: approx. 250 mm

P-1000011

Additionally required:

- P-1014525 Tube Holder S**
- P-1002843 Set of 15 Safety Patch Cords, 75 cm**
- P-1003310 High Voltage Power Supply, 5 kV (230 V, 50/60 Hz)**
- or
- P-1003309 High Voltage Power Supply, 5 kV (115 V, 50/60 Hz)**

Additionally recommended:

- P-1000611 Helmholtz Pair of Coils S**
- P-1003312 DC-Power Supply 0 – 20 V, 0 – 5 A (230 V, 50/60 Hz)**
- or
- P-1003311 DC-Power Supply 0 – 20 V, 0 – 5 A (115 V, 50/60 Hz)**

Luminescence Tube S

Highly evacuated electron tube with divergent electron gun and three fluorescent strips in red, green and blue. For demonstrating stimulated light emission during and after electron bombardment.

- Filament voltage: 6.3 V AC
- Max. anode voltage: 5000 V
- Anode current: approx. 0.1 mA at 4000 V
- Glass bulb: approx. 130 mm diam.
- Total length: approx. 250 mm

P-1000615

Additionally required:

- P-1014525 Tube Holder S**
- P-1002843 Set of 15 Safety Patch Cords, 75 cm**
- P-1003310 High Voltage Power Supply, 5 kV (230 V, 50/60 Hz)**
- or
- P-1003309 High Voltage Power Supply, 5 kV (115 V, 50/60 Hz)**

Perrin Tube S

Highly evacuated electron tube with focusing electron gun, fluorescent screen, and Faraday cage positioned on one side. For demonstrating the negative polarity of electrons and estimating the specific electron charge (charge to mass ratio) e/m by magnetic deflection into the Faraday cage, which is connected to an electroscope (P-1003048). It is also possible to investigate the deflection of electrons by two alternating magnetic fields at right-angles to each other or by parallel electric and magnetic fields and to demonstrate the effects, for example by generating Lissajous figures.

- Filament voltage: 6.3 V AC
- Max. anode voltage: 5000 V
- Anode current: approx. 0.1 mA at 4000 V
- Beam current: 4 μ A at 4000V
- Glass bulb: approx. 130 mm diam.
- Luminescent screen: approx. 85 mm diam.
- Total length: approx. 250 mm

P-1000616

Additionally required:

- P-1014525 Tube Holder S**
- P-1002843 Set of 15 Safety Patch Cords, 75 cm**
- P-1000611 Helmholtz Pair of Coils S**
- P-1003310 High Voltage Power Supply, 5 kV (230 V, 50/60 Hz)**
- P-1003312 DC-Power Supply 0 – 20 V, 0 – 5 A (230 V, 50/60 Hz)**
- or
- P-1003309 High Voltage Power Supply, 5 kV (115 V, 50/60 Hz)**
- P-1003311 DC-Power Supply 0 – 20 V, 0 – 5 A (115 V, 50/60 Hz)**

Additionally recommended:

- P-1003048 Electroscope**
- P-1000645 Auxiliary Coil**



P-1000615

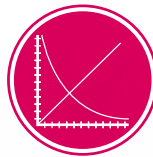

UE3070100
UE3070200
PDF online

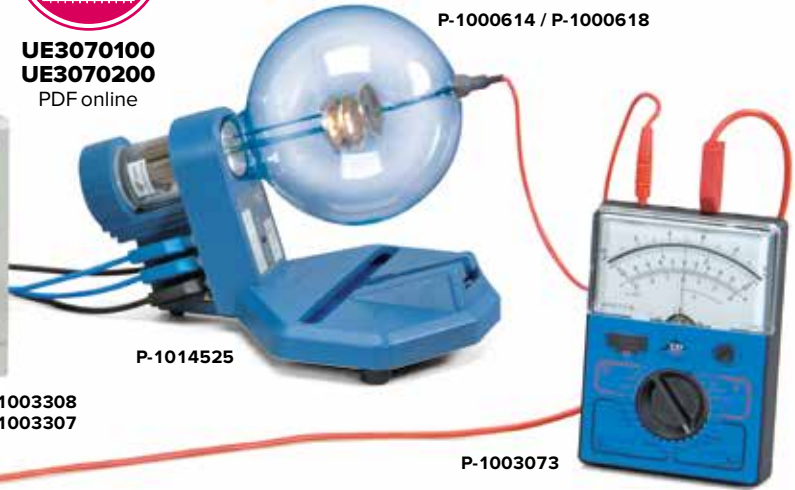

P-1000614 / P-1000618

P-1014525

P-1003308
P-1003307

P-1003073

Diode S

Highly evacuated electron tube with thermionic cathode and anode for investigating the thermoelectric effect (Edison effect) and measuring the emission current as a function of the heating power applied to the cathode. Also for plotting diode characteristics and for demonstrating the rectifying effect of a diode.

Max. heater voltage: 7.5 V AC/DC
Max. anode voltage: 500 V
Anode current: approx. 2 mA at 200 V Anode voltage
Glass bulb: approx. 130 mm diam.
Total length: approx. 250 mm

P-1000613

Additionally required:

- P-1014525 Tube Holder S**
- P-1002843 Set of 15 Safety Patch Cords, 75 cm**
- P-1003073 Analogue Multimeter AM50**
- P-1003308 Power Supply, 500 V DC (230 V, 50/60 Hz)**
- or
- P-1003307 Power Supply, 500 V DC (115 V, 50/60 Hz)**

Triode S

Highly evacuated electron tube with thermionic cathode, control grid and anode for quantitative investigation of controllable high vacuum tubes, plotting the characteristics of a triode, demonstrating the negative polarity of the electron charge, studying the practical applications of a triode as an amplifier and generating undamped oscillations in LC circuits

Max. heater voltage: 7.5 V AC/DC
Max. anode voltage: 500 V
Anode current: approx. 2 mA at 200 V anode voltage
Glass bulb: approx. 130 mm diam.
Total length: approx. 250 mm

P-1000614

Additionally required:

- P-1014525 Tube Holder S**
- P-1002843 Set of 15 Safety Patch Cords, 75 cm**
- P-1003073 Analogue Multimeter AM50**
- P-1003308 Power Supply, 500 V DC (230 V, 50/60 Hz)**
- or
- P-1003307 Power Supply, 500 V DC (115 V, 50/60 Hz)**

Gas Triode S

Electron tube filled with low pressure helium gas resp. neon gas, with thermionic cathode, control grid, and anode for quantitative investigations of the typical properties of a gas-filled triode, recording the $I_A - U_A$ characteristics of a thyratron, observing independent and dependent discharges as well as discontinuous energy release of He or Ne atoms during inelastic collisions with free electrons.

Max. heater voltage: 7.5 V AC/DC
Max. anode voltage: 500 V
Anode current: approx. 10 mA at 200 V anode voltage
Glass bulb: approx. 130 mm diam.
Total length: approx. 250 mm

Gas Triode S with He Filling

P-1000618

Gas Triode S with Ne Filling

P-1000619

Additionally required:

- P-1014525 Tube Holder S**
- P-1002843 Set of 15 Safety Patch Cords, 75 cm**
- P-1003073 Analogue Multimeter AM50**
- P-1003308 Power Supply, 500 V DC (230 V, 50/60 Hz)**
- or
- P-1003307 Power Supply, 500 V DC (115 V, 50/60 Hz)**



P-1000613

P-1000614 /
P-1000618 /
P-1000619



P-1013889

UE5010500
 PDF online

Dual Beam Tube S

Partly evacuated electron tube, filled with helium at low pressure, with tangential and axial electron gun. For determining specific charge e/m from the diameter of the filament beam in the case of tangential bombardment and a perpendicularly aligned magnetic field, and observing spiral paths of electrons in the case of axial bombardment and a co-axial magnetic field. The electron paths are rendered visible in the form of fine luminescent beams through impact excitation of the helium atoms.

Max. filament voltage:	7.5 V AC/DC
Max. anode voltage:	100 V DC
Anode current:	approx. 30 mA
Max. deflection voltage:	50 V DC
Glass bulb:	approx. 130 mm diam.
Total length:	approx. 250 mm

P-1000622

Additionally required:

- P-1014525 Tube Holder S**
- P-1002843 Set of 15 Safety Patch Cords, 75 cm**
- P-1000611 Helmholtz Pair of Coils S**
- P-1003308 Power Supply, 500 V DC (230 V, 50/60 Hz)**
- or
- P-1003307 Power Supply, 500 V DC (115 V, 50/60 Hz)**

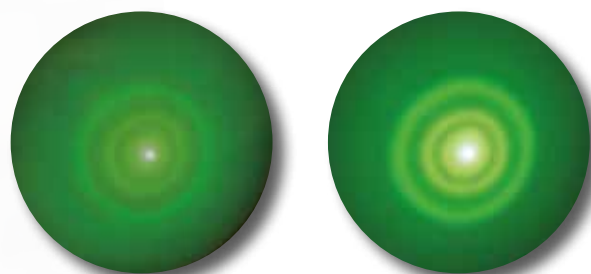

Recording in a darkened room with 3 kV and 4,5 kV.

Electron Diffraction Tube S

Highly evacuated electron tube for demonstrating the wave nature of electrons through the observation of interference caused by passage of electrons through a polycrystalline graphite lattice (Debye-Scherrer diffraction) and rendered visible on a fluorescent screen. Also intended for determining the wavelength as a function of the anode voltage from the radii of the diffraction rings and the lattice plane spacing of graphite, as well as confirming de Broglie's hypothesis.

Filament voltage:	6.3 V AC
Max. anode voltage:	5000 V
Anode current:	approx. 0.1 mA at 4000 V
Lattice constant of graphite:	$d_{10} = 0.213 \text{ nm}$, $d_{11} = 0.123 \text{ nm}$

P-1013889

Additionally required:

- P-1014525 Tube Holder S**
- P-1002843 Set of 15 Safety Experiment Leads, 75 cm**
- P-1003310 High Voltage Power Supply, 5 kV (230 V, 50/60 Hz)**
- or
- P-1003309 High Voltage Power Supply, 5 kV (115 V, 50/60 Hz)**



P-1000622

		P-1000613	P-1000614	P-1000618	P-1000619
		Diode S	Triode S	Gas Triode S with He Filling	Gas Triode S with Ne Filling
P-1014525	Tube Holder S	required	required	required	required
P-1002843	Set of 15 Safety Patch Cords, 75 cm	required	required	required	required
P-1002839	Experiment Lead, Safety Plug and Socket	–	–	–	–
P-1003308 or P-1003307	Power Supply, 500 V DC	required	required	required	required
P-1003310 or P-1003309	High Voltage Power Supply, 5 kV	–	–	–	–
P-1000611	Helmholtz Pair of Coils S	–	–	–	–
P-1003312 or P-1003311	DC-Power Supply, 20 V	–	–	–	–
P-1003073	Analogue Multimeter AM50	required	required	required	required
P-1000645	Auxiliary Coil	–	–	–	–
P-1003048	Electroscope	–	–	–	–

Tube Holder S

Tube holder to support all S series electron tubes for easy and safe operation. The five pin sockets for the tube are concealed inside the tube holder. A cathode protection switch is integrated into the tube holder, to protect the heated cathode from excessive voltage. The base plate has a slot for attaching the Helmholtz pair of coils S (P-1000611).

Terminals : 4 mm safety sockets
 Dimensions: approx. 130x190x250 mm³
 Weight: approx. 570 g

P-1014525



P-1014525

Replacement Circuit Board for Tube Holder S

The quality of the electron beam in electron defraction tube S (P-1013889) is affected by the resistance between sockets C5 (cathode) and F4 (heating filament) on the tube. For optimum results, the resistance needs to be 390 kΩ. Tube holder S (P-1014525) is accordingly designed such that this resistance is present. Older designs feature a much smaller resistance and need to be modified in order to work with the new S-series electron deflection tube (P-1013889).
 Tube holders affected: U18500, U185001, P-1000610

P-4008573



P-4008573

Helmholtz Pair of Coils S

Pair of coils for generating a uniform magnetic field perpendicular to the axis of a tube when using the tube holder S (P-1014525).

Number of turns: 320 each
 Coil diameter: 138 mm each
 Load rating: 1.0 A (Continuous operation) each
 1.5 A (Short-term operation)

Effective Resistance: approx. 6,5 Ω each
 Terminals: 4 mm safety sockets

P-1000611

Additionally recommended:

P-1003312 DC-Power Supply 0 – 20 V, 0 – 5 A (230 V, 50/60 Hz)
 or

P-1003311 DC-Power Supply 0 – 20 V, 0 – 5 A (115 V, 50/60 Hz)



P-1000611

P-1000622	P-1000615	P-1000011	P-1000616	P-1000617	P-1013889	P-1000624
Dual Beam Tube S	Luminescence Tube S	Maltese Cross Tube S	Perrin Tube S	Thomson Tube S	Electron Defraction Tube S	Gas Discharge Tube S
required	required	required	required	required	required	required
required	required	required	required	required	required	–
–	–	–	–	–	–	2x required
required	–	–	–	required	–	–
–	required	required	required	required	required	required
required	–	recommended	required	required	–	–
–	–	recommended	required	–	–	–
–	–	–	–	–	–	–
–	–	–	recommended	–	–	–
–	–	–	recommended	–	–	–



P-1000624

Gas Discharge Tube S

Evacuatable glass tube with fluorescent screens at both ends for observation of electrical discharges in gases under reduced pressure as well as for investigation of cathode beams and canal rays, which appear at low pressure outside the discharge path. Demountable design, installation in tube holder (P-1014525). Includes a needle ventilation valve and vacuum hoses.

Length: approx. 280 mm
 Polarization voltage: ≤ 5 kV
 Discharge current: approx. 1.2 mA
 Connections: 4 mm contact pins

P-1000624

Additionally required:

P-1014525 Tube Holder S
P-1002839 Experiment Lead, Safety Plug and Socket (2x)
P-1003317 Rotary-Vane Vacuum Pump, Two-Stage
P-1003310 High Voltage Power Supply, 5 kV (230 V, 50/60 Hz)
 or
P-1003309 High Voltage Power Supply, 5 kV (115 V, 50/60 Hz)

Gas Discharge Tube

Evacuatable glass tube for observation of luminous effects of electrical discharges in gases under reduced pressure. Glass tube with graded seal, disc shaped, perforated electrodes and 4 mm jacks for connecting the voltage supply.

Material: glass
 Dimensions: approx. 700 mm x 40 mm diam.
 Vacuum connection: graded seal NS 19/26

P-1002905

Additionally recommended:

P-1003310 High Voltage Power Supply, 5 kV (230 V, 50/60 Hz)
 or
P-1003309 High Voltage Power Supply, 5 kV (115 V, 50/60 Hz)
P-1002919 Rotary Vane Pump P 4 Z
P-1012514 Pirani Vacuum Gauge
P-1002923 2-Way Ball Valve DN 16 KF
P-1002924 Crosspiece DN 16 KF
P-1002929 Adaptor Flange DN 16 – Core NS 19/26
P-1002926 Ventilation Valve DN 16 KF
P-1002930 Tension Ring DN 10/16 KF (5x)
P-1002931 KF External Centring Ring DN 10/16 KF (5X)

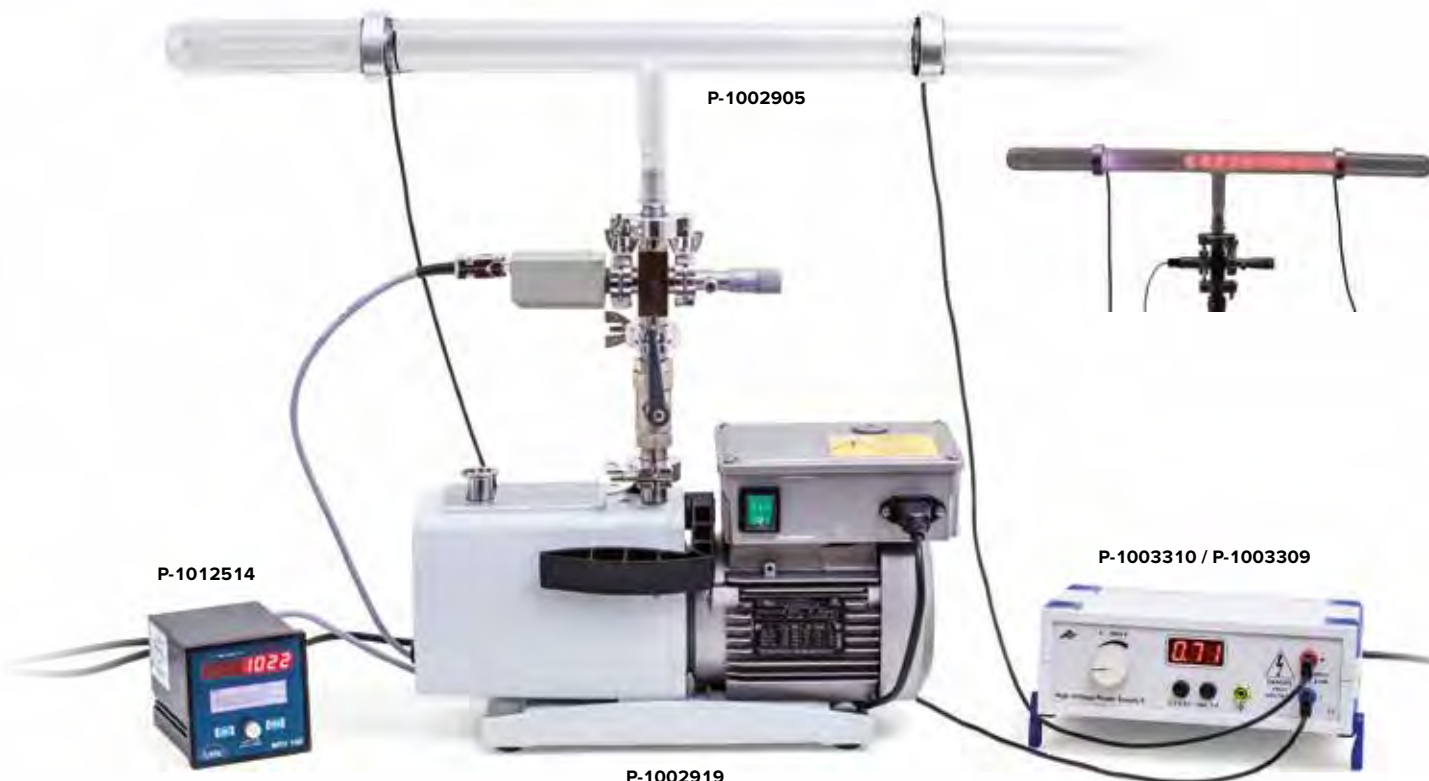

P-1002919

Experiment topics:

- Linear propagation of electrons in a zero-field space
- Deflection of electron beams in an electrical field
- Deflection of electron beams in a magnetic field
- Magnetic lens
- Phase displacement, superimposition of magnetic fields, Lissajous figures
- Determination of an electron's specific charge
- Determination of an electron's speed



Training Oscilloscope

Electron tube mounted on a terminal base for investigating the design and operation of a cathode ray tube. The electron beam can be deflected by an electric field produced by the deflection plates integrated into the tube, and by a magnetic field from three external coils mounted on a ring. A Wehnelt cylinder is used to focus the beam. The gas filling and the fluorescent screen make it possible to observe the beam in the tube. A continuously adjustable saw-tooth generator can be used to analyse and visualize time dependent processes. The device comes with a socket and printed wiring diagram.

Anode voltage:	250 – 350 V DC
Anode current:	1 mA
Filament voltage:	6 – 8 V AC/DC
Filament current:	0.3 A
Wehnelt voltage:	0 – 50 V DC
Deflection plate dimensions:	approx. 12x20 mm ²
Plate spacing:	approx. 14 mm

Electric deflection sensitivity:	0,2 mm/V
Screen diameter:	approx. 100 mm
Tube length:	approx. 260 mm
Residual gas:	Neon
Gas pressure:	10 ⁻⁴ hPa
Sweep frequency:	10 – 200 Hz, continuously adjustable
3 deflection coils:	600 turns each, with a centre pick up
Weight:	approx.1.6 kg

P-1000902

Additionally recommended:

P-1003308 DC Power Supply, 0 – 500 V (230 V, 50/60 Hz)

P-1009957 Function Generator FG100 (230 V, 50/60 Hz)

or

P-1003307 DC Power Supply, 0 – 500 V (115 V, 50/60 Hz)

P-1009956 Function Generator FG100 (115 V, 50/60 Hz)

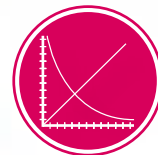
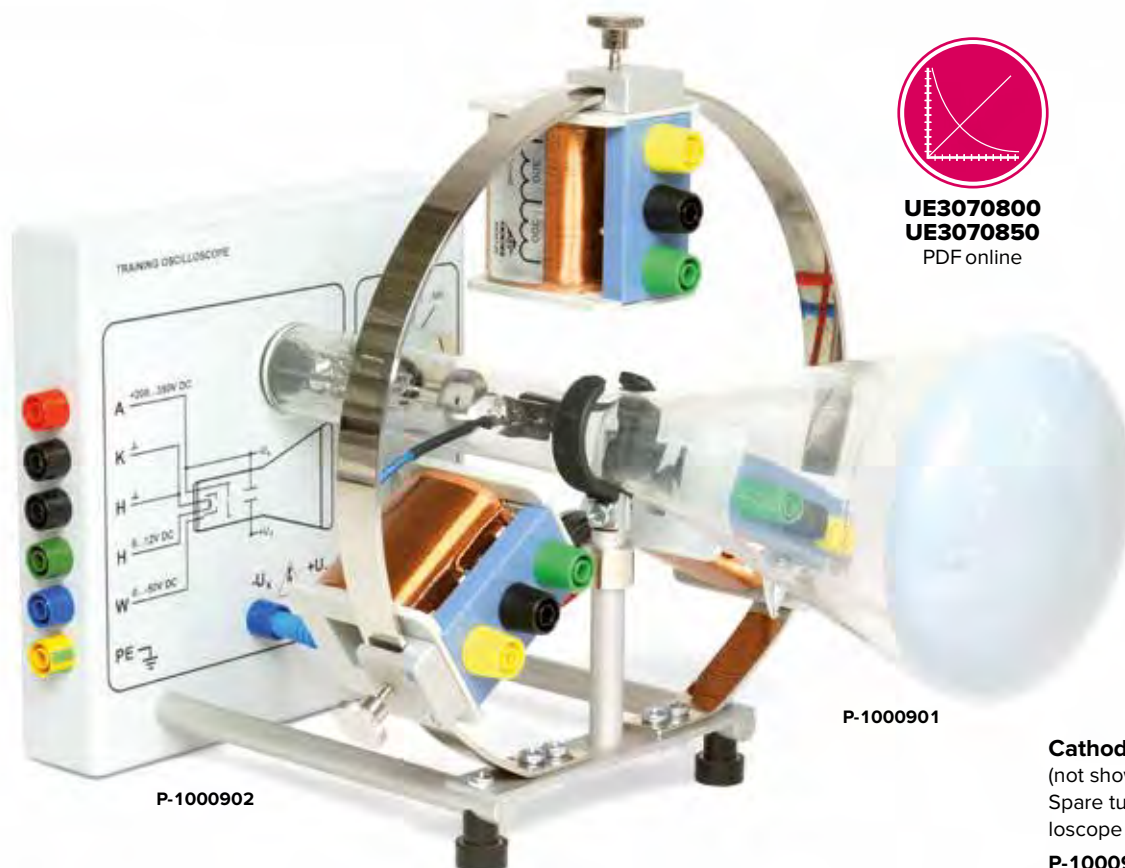

UE3070800
UE3070850
PDF online

P-1000901

Cathode Ray Tube

(not shown)

Spare tube for the training oscilloscope (P-1000902).

P-1000901

Experiment topics:

- Deflection of electrons in a closed circular path inside a magnetic field
- Determination of specific charge of an electron e/m

Fine Beam Tube on Connection Base

For examining the deflection of electron beams in a uniform magnetic field using a pair of Helmholtz coils (P-1000906) and for the quantitative determination of the specific charge of the electron e/m . Glass vessel with integrated electron beam system, consisting of an indirectly heated oxide cathode, a Wehnelt cylinder and a perforated anode, in neon residual gas atmosphere with precisely set gas pressure and with integrated measurement marks for parallax-free determination of the diameter of the fine beam. Gas atoms are ionized along the electron path and produce a sharply defined, visible fluorescent beam. Tube mounted on base with colour coded connectors.

Gas filling:	Neon
Gas pressure:	1.3×10^{-5} hPa
Filament voltage:	5 – 7 V DC
Filament current:	< 150 mA
Wehnelt voltage:	0 – -50 V
Anode voltage:	200 – 300 V
Anode current:	< 0.3 mA
Circular path diameter:	20 – 120 mm
Division spacing:	approx. 20 mm
Tube diameter:	approx. 160 mm
Dimensions:	approx. 115x115x35 mm ³
Weight:	approx. 820 g

P-1000904

Additionally required:

P-1000906 Helmholtz Coils, 300 mm

Additionally recommended:

P-1003308 DC Power Supply, 0 – 500 V (230 V, 50/60 Hz)

or

P-1003307 DC Power Supply, 0 – 500 V (115 V, 50/60 Hz)

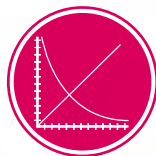
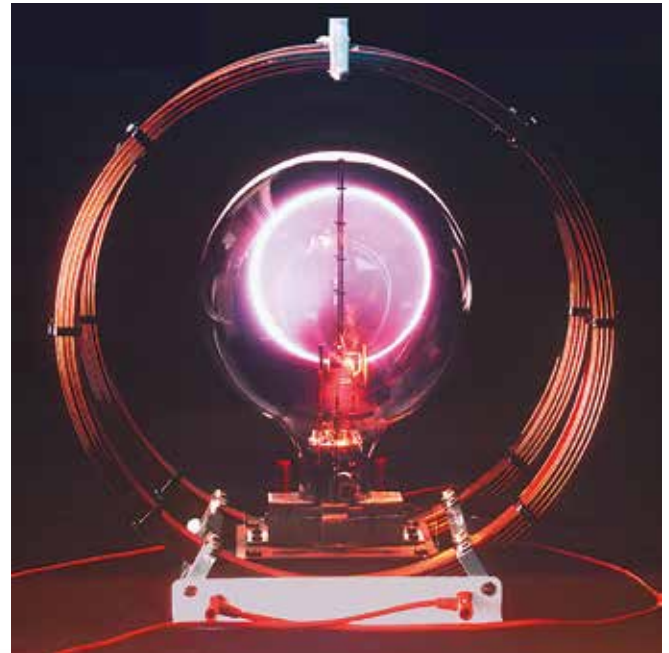
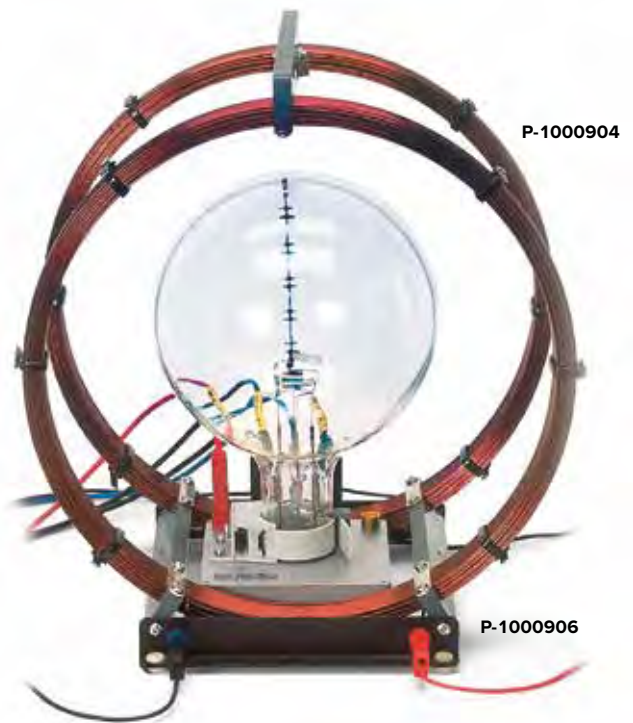

UE3070700
PDF online



Experiment topics:

- Electron deflection in a uniform magnetic field
- Closed orbit or spiral path
- Determining an electron's specific charge e/m

Complete Fine Beam Tube System

This complete experimental system is used to determine an electron's specific charge and investigate the deflection of electron beams in a uniform magnetic field. The system comes complete with a fine-beam tube, Helmholtz coil pair for generating a uniform magnetic field, and operating unit for power supply. The fine beam tube and Helmholtz coil pair are mounted on the operating unit, the fine beam tube being rotatable around its vertical axis. The tube and coil pair are both connected internally to the operating unit without a need for external wiring. All supply voltages for the tube and the current through the Helmholtz coils are adjustable. The anode voltage and coil current are displayed digitally and can be tapped additionally as equivalent voltage values. Inside the fine beam tube, a sharply delimited electron beam is generated by a system comprising an indirectly heated oxide cathode, perforated anode and Wehnelt cylinder. Impact ionization of helium atoms creates a very bright, also sharply delimited trace of the electron path in the tube. If the tube is aligned optimally and an appropriate current flows through the Helmholtz coils, the electrons are deflected into a circular orbit, whose diameter can be easily determined when the electrons strike one of the equidistant measurement marks, causing its end to light up. Diameter, anode voltage and magnetic field are the parameters used to determine the electron's specific charge. The magnetic field can be calculated from the coil current, the geometry of the Helmholtz coil pair being known.

Fine-beam tube:

Gas filling: Helium
 Gas pressure: 0.13 hPa
 Bulb diameter: 165 mm
 Orbit diameter: 20 – 120 mm
 Measurement mark spacing: 20 mm

Helmholtz coil pair:

Coil diameter: approx. 300 mm
 Winding count: 124
 Magnetic field: 0 – 3.4 mT (0.75 mT/A)

Operating unit:

Coil current: 0 – 4.5 A, 3-figure digital display
 Measurement output: $1 V^*IB / A$
 Anode voltage: 15 – 300 V, 3-figure digital display
 Measurement output: $0.01^* UA$
 Heating voltage: 5 – 7 V
 Wehnelt voltage: 0 – -50 V

General data:

Tube's rotary angle: $-10^\circ - 270^\circ$
 Supply voltage: 100 – 240 V, 50/60 Hz
 Power supply cable: EU, UK and US
 Dimensions: approx. $310 \times 275 \times 410 \text{ mm}^3$
 Weight: approx. 7.5 kg

P-1013843

The complete fine-beam tube system consists of the following parts:

Fine Beam Tube T

P-1008505

Operating Unit for Fine-Beam Tube

P-1009948

Recording in a darkened room



Circular path



Spiral path



P-1009948

Periodic Table of the Elements, with Electron Configurations

Chart of the periodic table of the elements showing the configurations of electron shells. On strong laminated material with rods and hanging cord. Bilingual.

Dimensions: 1950x1380 mm² approx.

Languages: English and German

P-1017655

Periodic Table of the Elements, with Pictures

Chart of the periodic table of the elements with pictures of the elements. On strong laminated material with rods and hanging cord. In four languages.

Dimensions: 1950x1380 mm² approx.

Languages: English, German, French, Spanish

P-1013907

This image shows a standard periodic table of elements. The title is split into two parts: "PERIODENSYSTEM DER ELEMENTE" on the left and "PERIODIC TABLE OF THE ELEMENTS" on the right. The table is color-coded by groups: Group 1 (yellow), Group 2 (orange), Groups 3-10 (transition elements, teal), Groups 11-18 (main group elements, various colors). It includes labels for "Hauptgruppen" (Main Groups) and "Nebengruppen" (Subgroups) in German, and "Main Group Elements" and "Transition Elements" in English. The lanthanoid and actinoid series are shown as separate rows below the main table. The periodic number (1-7) is listed on the right side of the table.

P-1017655

This image shows a periodic table where each element's cell contains a small photograph of the element. The title is in three languages: "Periodensystem der Elemente", "Periodic System of the Elements", and "Système périodique des éléments". Below the title is the Spanish title "Sistema periódico de los elementos". The table is organized into groups labeled with Roman numerals and numbers in parentheses: I (1), II (2), III (13), IV (14), V (15), VI (16), VII (17), VIII (18), IIIA (3), IVA (4), VA (5), VIA (6), VIIA (7), VIIIA (8/9/10), IA (11), and IIA (12). The lanthanoid and actinoid series are shown at the bottom. The periodic number (1-7) is listed on the left side of the table.

P-1013907



UE5010300
PDF online

Insight into the World of Atoms

Experiment topics:

- Tunnel effect
- Representation of individual atoms
- Representation of lattice defects and dislocations
- Representation of charge density waves
- Dependence of tunnel current on distance between measuring tip and sample
- PID control of tunnel current

MoS₂ Sample (not shown)

Molybdenum-sulphide sample on a carrier for observing defects in crystal lattices with the scanning tunnelling microscope.

P-1012877

TaS₂ Sample (not shown)

Tantalum-disulfide sample on a carrier for observing the distribution of surface charge density (stationary charge-density waves) with a scanning tunnelling microscope.

P-1012876

TaSe₂ Sample (not shown)

Tantalum-diselenide sample on a carrier for observing the distribution of surface charge density (stationary charge-density waves) with a scanning tunnelling microscope.

P-1012875

Representation of a gold surface

Representation of a TaS₂ surface by means of stationary charge-density waves

Representation of the hexagonal structure of a graphite surface

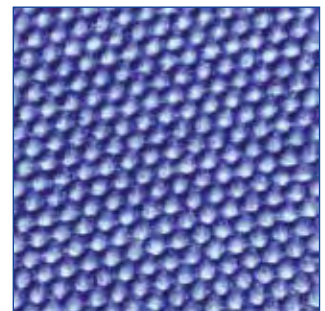
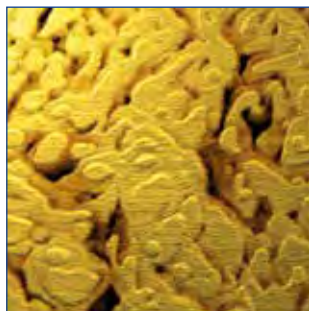

P-1012782

Scanning Tunnelling Microscope

Meant to resolve atomic structures at the surface of electrically conductive materials, this easy-to-use and compact, scanning tunnelling microscope is particularly suitable for training purposes. The complete system includes a probe for row-by-row scanning of sample surfaces with the measuring tip, vibration-absorbing pad, controller with computer interface, as well as graphite and gold samples.

System requirements: Windows 2000 or higher
 XYZ grid: 500x500x200 nm³
 Minimum increment XY: 7.6 µm
 Minimum increment Z: 3 µm
 Tunnel current: 0.100 – 100.000 nA (0.025 nA increment)
 Voltage: ±10.000 V (0.005 V increment)
 Maximum sample size: 10 mm diam.
 Supply voltage: 90 – 240 V, 50/60 Hz
 Connection: USB

Contents:

Controller
 Installation CD with measurement and control software
 Scanning probe with connection cable
 Cover with lens
 Experiment plate with vibration damping
 Tool kit for manufacturing the probe tip (side cutters, flat-nose pliers, pointed and rounded tweezers)
 Platinum-iridium wire, 0.25 mm diam., 300 mm
 Graphite (HOPG) sample on a carrier
 Gold (1.1) sample on a carrier
 Set of 4 sample carriers

P-1012782

WSe₂ Sample (not shown)

Tungsten-diselenide sample on a carrier for observing surface defects with a scanning tunnelling microscope.

P-1012874

Platinum-Iridium Wire (not shown)

Platinum-iridium wire, 0.25 mm Ø, 300 mm as spare wire for manufacturing measuring tips for the scanning tunnelling microscope.

P-1012878

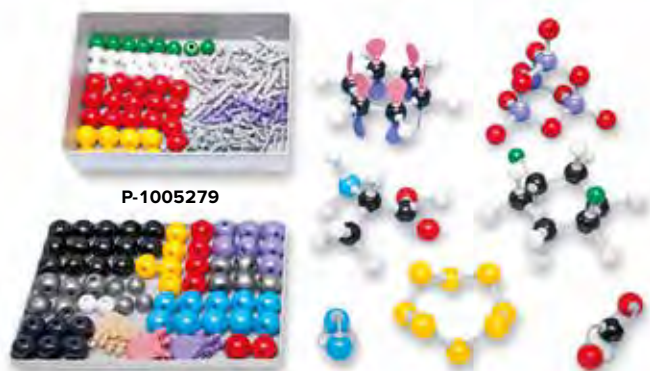

P-1005279

Organic/Inorganic Molecule Set D

Molecule building set for assembling three-dimensional models of organic and inorganic molecules and for clarification of their spatial configurations. Many chemical compounds can be represented clearly. These include simple molecules such as hydrogen, oxygen and water, organic compounds such as ethane, ethene, ethyne, benzene, alanine, glucose, and cyclohexane and also more complex structures such as the tetrammino zinc ion or tetraphosphorous decoxide.

P-1005279

Contents:

Atoms					
14	C	black	4 wholes	tetrahedral	109°
6	C	dark blue	5 wholes	tribipyramidal	90°, 120°
12	H	white	1 whole	one sided	
2	H	white	1 whole	linear	180°
16	O	red	2 wholes	angular	105°
6	O	red	4 wholes	tetrahedral	109°
6	N	blue	4 wholes	tetrahedral	109°
4	N	blue	3 wholes	pyramidal	107°
4	S	yellow	4 wholes	tetrahedral	109°
1	S	yellow	6 wholes	octahedral	90°
8	S	yellow	2 wholes	angular	105°
8	Cl, (F)	green	1 wholes	one sided	
4	P	purple	4 wholes	tetrahedral	109°
1	P	purple	5 wholes	tribipyramidal	90°, 120°
2	P	purple	3 wholes	pyramidal	107°
4	Na	grey	1 whole	one sided	
3	Ca, Mg	grey	2 wholes	angular	105°
2	Al	grey	3 wholes	trigonal	120°
4	Si, Cu	grey	4 wholes	tetrahedral	109°
1	metal atom	grey	6 wholes	octahedral	90°

Electron clouds		
6	lone pair	light beige
6	unhybridised p-lobe	purple
6	unhybridised p-lobe	pink

Links		
38	medium	light grey
12	medium	purple
36	long, flexible	grey



P-1005290

Organic Molecule Set S

Molecule building set for assembling three-dimensional models of organic molecules and for clarification of their spatial configurations. Many chemical compounds can be represented clearly and phenomena such as structural isomerism, optical isomerism and geometric isomerism can be illustrated. The spectrum ranges from simple molecules such as alkanes, alkenes and alkynes, alcohols, aldehydes, ketones, carboxylic acids, esters, ethers, halogenated compounds, amines, amides, cycloalkanes to biochemical molecules, amino acids, aromatic molecules and polymers.

P-1005290

Contents:

Atoms					
12	C	black	4 wholes	tetrahedral	109°
20	H	white	1 whole	one sided	
6	O	red	2 wholes	angular	105°
2	N	blue	4 wholes	tetrahedral	109°
2	N	blue	3 wholes	pyramidal	107°
1	S	yellow	4 wholes	tetrahedral	109°
1	S	yellow	6 wholes	octahedral	90°
4	Cl, (F)	green	1 whole	one sided	
1	P	purple	4 wholes	tetrahedral	109°
1	Na	grey	1 whole	one sided	

Links		
26	short	white
6	medium	light grey
12	long, flexible	grey

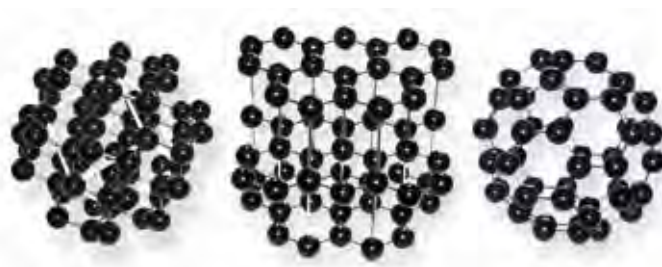

P-1012836

Set of 3 Carbon Configurations

Set of 3 easy-to-use models of various carbon crystal structures: diamond, graphite and fullerene, for demonstrating the fundamental differences between the structures.

Ball diameter: 25 mm approx.

Lengths of sides: 150 mm approx.

P-1012836

P-1005291



Organic/Inorganic Molecule Set S

Molecule building set for assembling three-dimensional models of organic and inorganic molecules and for clarification of their spatial configurations. Many chemical compounds can be represented clearly. These include inorganic molecules such as hydrogen, oxygen, water, acids, salts, metal oxides, and non metal oxides and also organic compounds such as ethane, ethene, ethyne, benzene, alanine, glucose, and cyclohexane.

P-1005291

Contents:

Atoms					
6	C	black	4 wholes	tetrahedral	109°
14	H	white	1 whole	one sided	
6	O	red	2 wholes	angular	105°
1	O	red	4 wholes	tetrahedral	109°
2	N	blue	4 wholes	tetrahedral	109°
1	N	blue	3 wholes	pyramidal	107°
1	S	yellow	4 wholes	tetrahedral	109°
1	S	yellow	6 wholes	octahedral	90°
6	Cl, (F)	green	1 wholes	one sided	
1	P	purple	5 wholes	tribipyramidal	90°, 120°
1	P	purple	3 wholes	pyramidal	107°
2	Na	grey	1 wholes	one sided	
2	Ca, Mg	grey	2 wholes	angular	105°
1	Be	grey	2 wholes	linear	180°
1	Al	grey	3 wholes	trigonal	120°
1	Si, Cu	grey	4 wholes	tetrahedral	109°
1	metal atom	grey	6 wholes	octahedral	90°
1	B	light beige	3 wholes	trigonal	120°
1	atom	beige	4 wholes	tetrahedral	109°
1	atom	beige	5 wholes	tribipyramidal	90°, 120°
1	atom	beige	6 wholes	octahedral	90°

Electron clouds

3	lone pair	light beige
---	-----------	-------------

Links

20	medium	light grey
5	medium	purple
12	lang flexibel	grey

Set 14 Bravais Lattices

Set of easy to handle models of the 14 fundamental lattice types (Bravais lattices), from which Auguste Bravais postulated that practically all naturally occurring crystal lattices can be derived by shifting along the axes. Made of wooden balls in six different colours connected via metal rods. The six colours distinguish the six different systems into which the lattice types are categorised.

Diameter of balls: 25 mm approx.
Length of sides: 150 mm approx.

P-1012837

P-1005278



Organic Molecule Set D

Molecule building set for assembling three-dimensional models of organic molecules and for clarification of their spatial configurations. Many chemical compounds can be represented clearly and phenomena such as structural isomerism, optical isomerism and geometric isomerism can be illustrated. The spectrum ranges from simple molecules such as alkanes, alkenes and alkynes, alcohols, aldehydes, ketones, carboxylic acids, esters, ethers, halogenated compounds, amines, amides, cycloalkanes to biochemical molecules, amino acids, aromatic molecules and polymers.

P-1005278

Contents:

Atoms					
24	C	black	4 wholes	tetrahedral	109°
6	C	dark grey	3 wholes	trigonal	120°
2	C	dark grey	2 wholes	linear	180°
6	C	dark blue	5 wholes	tribipyramidal	90°, 120°
40	H	white	1 whole	one sided	
12	O	red	2 wholes	angular	105°
4	N	blue	4 wholes	tetrahedral	109°
1	S	yellow	4 wholes	tetrahedral	109°
1	S	yellow	2 wholes	angular	105°
8	Cl, (F)	green	1 whole	one sided	
4	P	purple	4 wholes	tetrahedral	109°
2	Na	grey	1 whole	one sided	
1	Ca, Mg	grey	2 wholes	angular	105°

Electron clouds

6	lone pair	light beige
6	unhybridised p-lobe	purple
6	unhybridised p-lobe	pink

Links

60	short	white
55	medium	light grey
25	long, flexible	grey

P-1012837



Hands-on atomic shells!

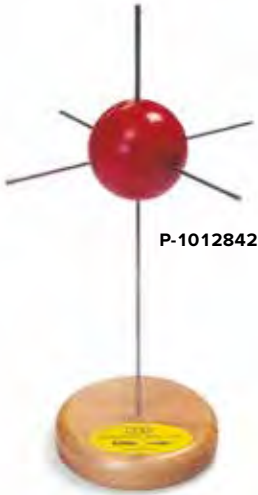

P-1012842

s-Orbital

Three-dimensional model of the s-orbital in the wave functions of hydrogen. With base. Made of hard wood mounted on a nickel coated steel axle.

Height: 250 mm approx.

P-1012842

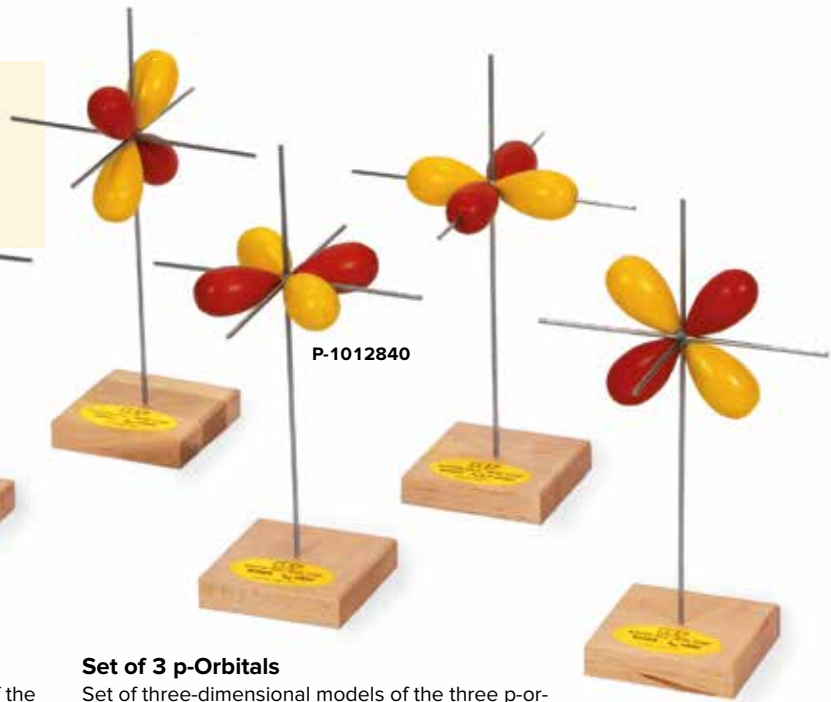

P-1012840

Set of 3 p-Orbitals

Set of three-dimensional models of the three p-orbitals in the wave functions of hydrogen. With base.

Made of hard wood mounted on a nickel coated steel axle.

Two colours to indicate the change in sign in the wave functions.

Height: 250 mm approx.

P-1012841

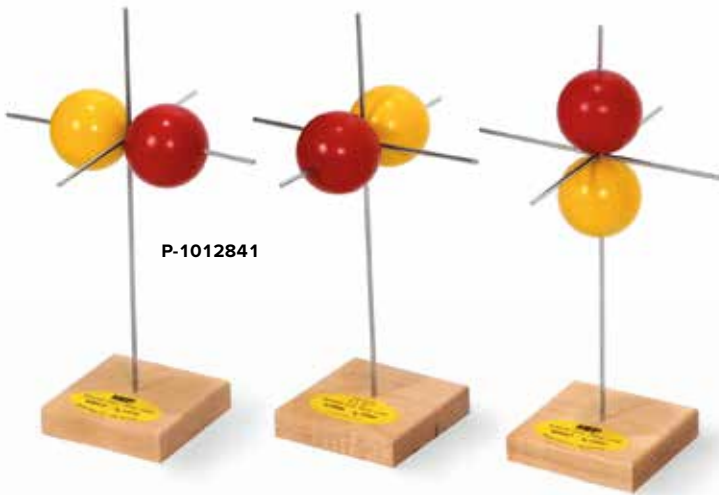

P-1012841

Set of 5 d-Orbitals

Set of three-dimensional models of the five d-orbitals in the wave functions of hydrogen. With base. Made of hard wood mounted on a nickel coated steel axle. Two colours to indicate the change in sign in the wave functions.

Height: 250 mm approx.

P-1012840

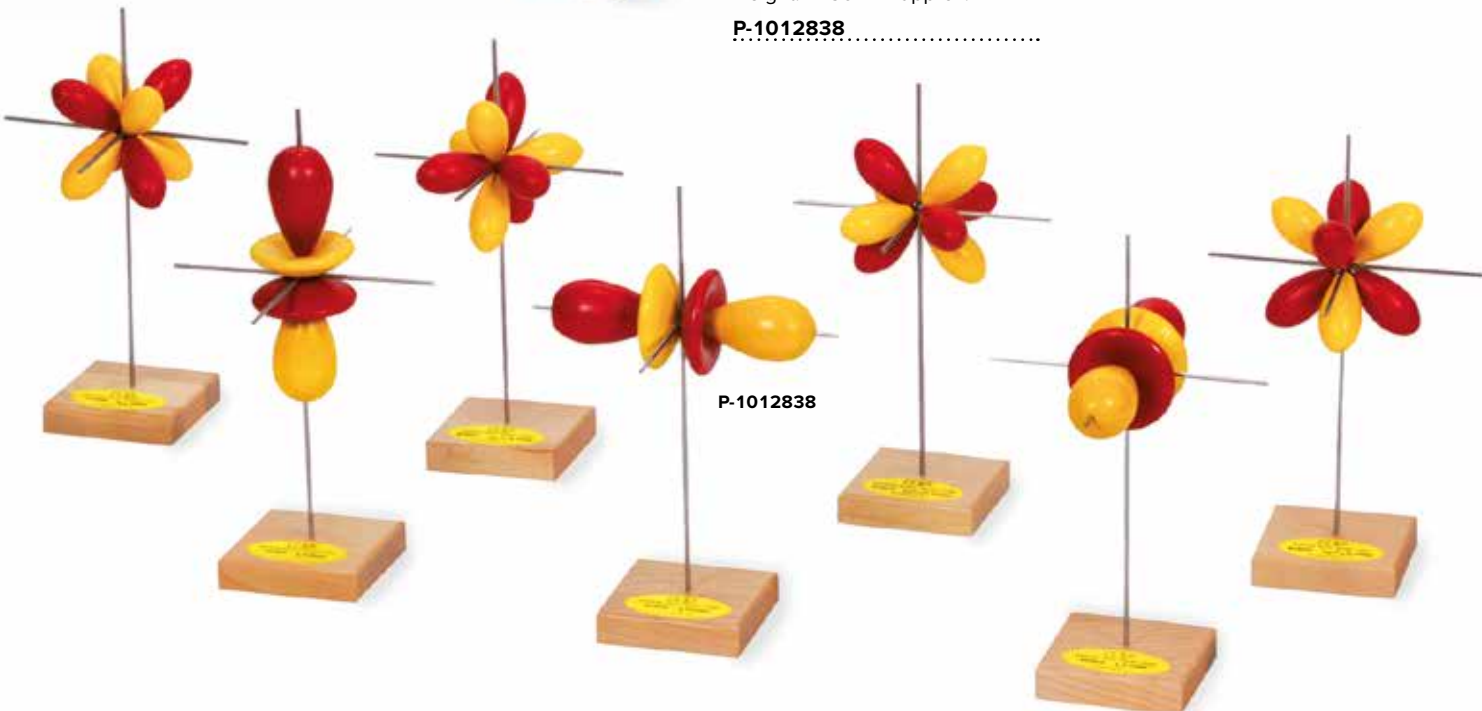

P-1012838

Set of 7 f-Orbitals

Set of three-dimensional models of the seven f-orbitals in the wave functions of hydrogen. With base. Made of hard wood mounted on a nickel coated steel axle. Two colours to indicate the change in sign in the wave functions.

Height: 250 mm approx.

P-1012838

Experiment topics:

- Millikan's experiment
- Discrete nature (quantisation) of electric charge
- Elementary electric charge
- Charged oil droplets in an electric field
- Stokes viscous drag, weight, buoyancy
- Equilibrium voltage
- Velocity of fall and velocity of rise

Advantages

- Compact instrument with built-in measurement and display unit
- Touch-sensitive screen for simple and ergonomic operation
- Maintenance-free lighting unit for uniform lighting via two green LEDs
- Built-in pressure and temperature sensor for automatically determining the relevant parameters, temperature, viscosity and pressure



P-1019214
P-1019213

Our low-cost compact solution

new

Millikan's Apparatus

Compact apparatus for demonstrating the discrete nature (quantisation) of electric charge and for determining the elementary charge of an electron. Comprising an experiment chamber kit for assembly with plate capacitor and connected oil atomiser, lighting unit with two green LEDs, measuring microscope, voltage adjustment knob and switch to set the capacitor voltage, switch for starting and stopping rise and fall time measurements and a display unit with touch screen. Measurements can be made using the floating method or the rising and falling method. Measured rise and fall times for a charged droplet of oil are displayed on the touch screen along with the configured voltage. Parameters relevant to the evaluation of the results, temperature, viscosity and pressure are also displayed. Includes plug-in power supply, 12 VAC, 1 A.

Dimensions (including measuring microscope): 370x430x235 mm³
Weight (including plug-in power supply): 4.3 kg approx.

Contents:

- 1 Basic apparatus with experiment chamber and display unit
- 1 Measuring microscope
- 1 Oil atomiser
- 50 ml of oil for Millikan's apparatus
- 1 Plug-in power supply, 12 VAC, 1 A

Millikan's Apparatus (230 V, 50/60 Hz)

P-1019214

Millikan's Apparatus (115 V, 50/60 Hz)

P-1019213

Oil for Millikan's Apparatus

50 ml of oil for experiments using Millikan's apparatus.

P-1013318



P-1013318

Experiment Topics:

- Energy of a photon
- Mean emission wavelength for a light emitting diode
- Characteristic of an LED
- Cut-off voltage

Light Emitting Diodes for Determination of h

Mounting plate with six coloured light-emitting diodes with different emission wavelengths for determining Planck's constant h by measuring the cut-off voltage as a function of the frequency of the emitted light. Light-emitting diodes with series resistors mounted on a base plate with a stem. Contact can be made from the rear via safety connector plugs..

Wavelengths: 465 nm, 560 nm, 585 nm, 635 nm, 660 nm, 950 nm
 Series resistor: 100 Ω
 Max. voltage: 6 V
 Dimensions: 115x115 mm² approx.
 Weight: 120 g approx.

P-1000917

Additionally required:

- P-1003312 DC-Power Supply 0 – 20 V, 0 – 5 A (230 V, 50/60 Hz)**
- or
- P-1003311 DC-Power Supply 0 – 20 V, 0 – 5 A (115 V, 50/60 Hz)**
- P-1013527 Analogue Multimeter, Escola 100**
- P-1001046 Stand base**
- Experiment leads

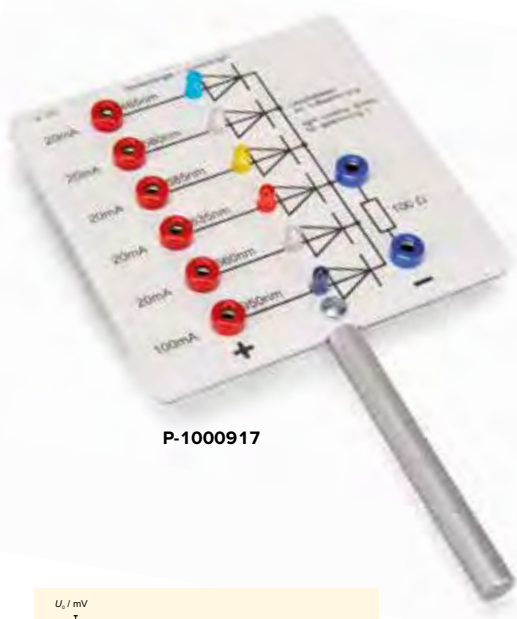

P-1000917

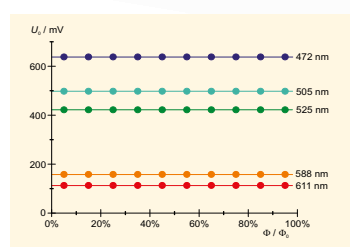

Cut-off voltage U_0 as a function of intensity (Planck's Constant Apparatus)

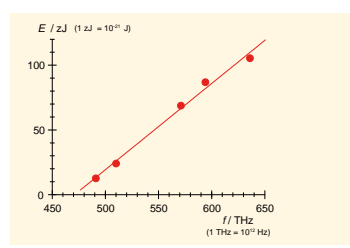

Graph of energy against frequency (Planck's Constant Apparatus)

Experiment Topics:

- Energy of a photon
- Mean emission wavelength for a light emitting diode
- Photocell
- Photo-electric effect and kinetic energy of electrons
- How electron energy depends on wavelength.
- How electron energy is independent of light intensity

Advantages

- Simple, safe and quick-to-operate compact device
- Accuracy < 5%
- Capable of demonstrating how electron energy is independent of light intensity



UE5010200
PDF online



P-1000537
P-1000536

Planck's Constant Apparatus

Simple, safe and quick-to-operate, compact apparatus with integrated photocell as well as a voltmeter and nano-ammeter for determining Planck's constant and the work done in emitting an electron using the stopping potential method. Five light emitting diodes (LEDs) of known mean wavelengths act as light sources of differing frequencies. The intensity of the light emitted by them can be varied from 0 to 100%.
 Wavelengths: 472 nm, 505 nm, 525 nm, 588 nm, 611 nm
 Dimensions: 280x150x130 mm³
 Weight: 1.3 kg approx.

Contents:

- 1 Basic apparatus with photocell, voltmeter, nano-ammeter and power supply for light sources
- 5 LEDs in casings with connector leads
- 1 Plug-in power supply 12 V AC

Planck's Constant Apparatus (230 V, 50/60 Hz)

P-1000537

Planck's Constant Apparatus (115 V, 50/60 Hz)

P-1000536

P-1000915

Vacuum Photocell

Evacuated photocell for demonstrating the photoelectric effect and showing that the emission of electrons increases with increasing light intensity. Mounted ready for use on a base plate with electrical wiring and clamping bar.

Cathode:	Caesium on oxidised silver
Cathode area:	2.4 cm ²
Operating voltage:	50 V, max. 200 V
Working resistance:	1 MΩ
Dark current:	<0.05 μA
Sensitivity:	20 μA/lumen
Photoelectric current density:	max. 3.0 μA/cm ²

P-1000915

P-1000916

Gas Filled Photocell

Gas-filled photocell for demonstrating the photoelectric effect with simple measuring instruments for use by students that also shows how the emission of electrons increases with increasing light intensity. Mounted ready for use on a base plate with electrical wiring and clamping bar.

Cathode:	Caesium on oxidised silver
Cathode area:	2.4 cm ²
Operating voltage:	50 V, max. 90 V
Working resistance:	1 MΩ
Dark current:	<0.1 μA
Sensitivity:	125 μA/Lumen
Photoelectric current density:	max. 0.7 μA/cm ²

P-1000916

**External Photoelectric Effect
(Hallwachs Effect):**
Equipment:

- P-1000852 High-Pressure Mercury Vapour Lamp
- P-1006813 Electrometer Accessories
- P-1002835 Tripod Stand, 150 mm
- P-1002933 Stainless Steel Rod, 250 mm
- P-1002830 Universal Clamp
- P-1003073 Analogue Multimeter AM50
- P-1003196 Control Unit for Spectrum Lamps (230 V, 50/60 Hz)
- P-1008535 DC Power Supply 450 V (230 V, 50/60 Hz)
- P-1001025 Electrometer (230 V, 50/60 Hz)
- or
- P-1003195 Control Unit for Spectrum Lamps (115 V, 50/60 Hz)
- P-1008534 DC Power Supply 450 V (115 V, 50/60 Hz)
- P-1001024 Electrometer (115 V, 50/60 Hz)

High-Pressure Mercury Vapour Lamp

High-pressure mercury vapour lamp in hardened glass bulb made of blackened borosilicate glass, with tube-shaped hole allowing emission of unfiltered ultra-violet radiation. Includes E27 lamp holder on stem and see-through screen to protect users from UV radiation.

Wavelength ranges:	UV-A, UV-B, UV-C
Power consumption:	125 W

P-1000852

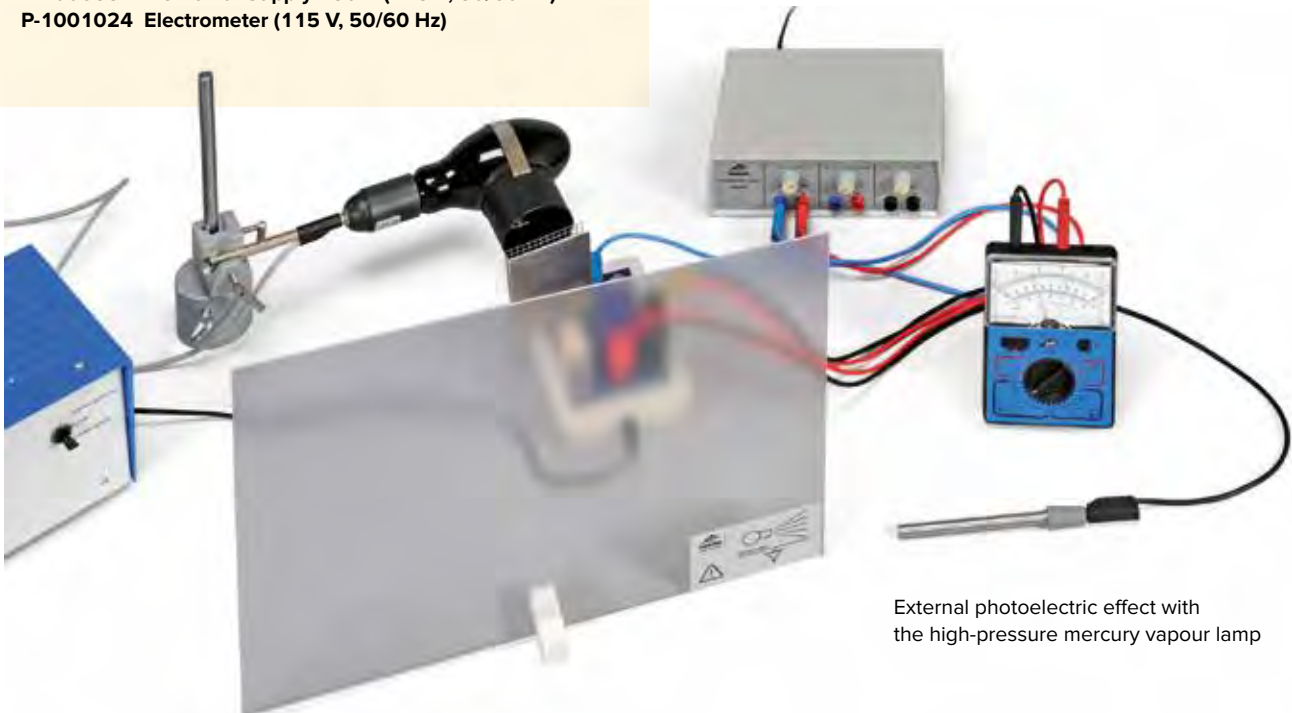

External photoelectric effect with the high-pressure mercury vapour lamp



Franck-Hertz experiment with neon

Franck-Hertz Experiment

The quantization of energy and the generation, recording and evaluation of spectra, along with the experimental verification thereof, is included in most of the curricula used around the world. The well known experiment first performed by James Franck and Gustav Hertz in 1913 is critically important in terms of demonstrating discrete energy states in atoms.

Power Supply Unit for Franck-Hertz Experiment

Power supply unit for operating the mercury filled Franck-Hertz tube (P-1006795 resp. P-1006794), the neon filled Franck-Hertz tube (P-1000912) or the critical potential tubes (P-1000620 and P-1000621). The equipment provides all the voltages needed to power the tubes and includes a sensitive built-in DC amplifier for measuring collector current. The voltages can simultaneously be read off a display. The accelerating voltage can be set-up manually on the apparatus or set to a saw-tooth wave form. Additional measuring inputs are also available for the anode current and accelerating voltage.

- Filament voltage U_F : 4 – 12 V, continuously adjustable
- Control voltage U_G : 0 – 12 V, continuously adjustable
- Accelerating voltage U_A : 0 – 80 V
- Modes of operation: manually adjusted / saw-tooth
- Countervoltage U_E : 0 – ± 12 V, continuously adjustable, switchable polarity

- Output U_E for collector current I_E : $I_E = U_A \cdot 38 \text{ nA/V}$ (0 – 12 V)
- Output U_Y for accelerating voltage U_A : $U_X = U_A / 10$
- Outputs: 4 mm safety sockets
- Input: BNC socket
- Dimensions: 160x132x210 mm³ approx.
- Weight: 3.4 kg approx.



P-1012819
P-1012818

Power Supply Unit for Franck-Hertz Experiment (230 V, 50/60 Hz)

P-1012819

Power Supply Unit for Franck-Hertz Experiment (115 V, 50/60 Hz)

P-1012818



UE5020400
PDF online

Franck-Hertz experiment with mercury

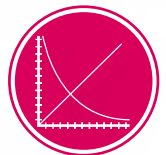

UE5020300
PDF online

Franck-Hertz Tube with Neon Filling on Base

Highly evacuated electron tube containing neon, mounted on a base with socket connection for demonstrating that free electrons colliding with neon atoms emit energy in quantized packets and for determining the excitation energy of the 3P_0 or 3S_1 states at about 19 eV. When excited, these states emit visible light due to the energy drop from intermediate levels to a ground state at an excitation energy of about 16.7 eV. The light so emitted is in the red-yellow region of the spectrum. Parallel bands of light are formed between the control grid and the accelerator grid and can be observed through a window. The Franck-Hertz neon tube can be operated at room temperature. Tetraode with indirectly heated cathode, mesh control grid, mesh accelerating grid and collector (counter) electrode. Mounted on a base with colour coded connection sockets.

Filament voltage:	4 – 12 V
Control voltage:	9 V
Accelerating voltage:	max. 80 V
Counter voltage:	1.2 – 10 V
Tube:	130 mm x 26 mm diam. approx
Base with connector sockets:	190x115x115 mm ³ approx.
Weight:	450 g approx.

P-1000912

Additionally required:

P-1012819 Power Supply Unit for Franck-Hertz Experiment (230 V, 50/60 Hz)

or

P-1012818 Power Supply Unit for Franck-Hertz Experiment (115 V, 50/60 Hz)

P-1002727 Analogue Oscilloscope 2x30 MHz



P-1000912



Replacement Tubes for Franck-Hertz Experiment

Franck-Hertz Tube with Hg

P-1003549

Franck-Hertz Tube with Ne

P-1003550

P-1003550



P-1003549



Franck-Hertz Tube with Mercury Filling and Heating Chamber

Highly evacuated electron tube containing mercury in a heating chamber for demonstrating the discrete nature (quantization) of the energy released by free electrons in collisions with mercury atoms, and for determining the excitation energy of the mercury resonance line ($6^1S_0 - 6^3P_1$), which is 4.9 eV. The electron tube must be heated in the chamber to generate the necessary mercury vapour pressure to achieve a sufficiently high probability of collisions between electrons and mercury atoms. Electron tube with a plane parallel electrode system consisting of an indirectly heated oxide cathode with aperture, a grid and a collecting electrode. Front plate with printed tube symbol visible from a distance. Electric heating chamber with continuous temperature control and digital temperature display showing actual and set-point temperatures. In lacquered metal housing with two observation windows, opening with spring clip for thermometer, and thermally insulated carrying handle. Temperature measurement and control is handled by an integrated microcontroller and a Pt100 thermocouple.

Heater voltage:	4 – 12 V
Grid voltage:	0 – 70 V
Suppressor voltage:	1.5 V approx.
Tube dimensions:	130 mm x 26 mm diam. approx.
Heater output:	400 W
Temperature range:	160° C – 240° C
Temperature constancy:	±1° C approx.
Overall dimensions:	335x180x165 mm ³ approx.
Weight:	5.6 kg approx.

Franck-Hertz Tube with Mercury Filling and Heating Chamber (230 V, 50/60 Hz)

P-1006795

Franck-Hertz Tube with Mercury Filling and Heating Chamber (115 V, 50/60 Hz)

P-1006794

Additionally required:

P-1012819 Power Supply Unit for Franck-Hertz Experiment (230 V, 50/60 Hz)

or

P-1012818 Power Supply Unit for Franck-Hertz Experiment (115 V, 50/60 Hz)

P-1002727 Analogue Oscilloscope 2x30 MHz

P-1006795
P-1006794



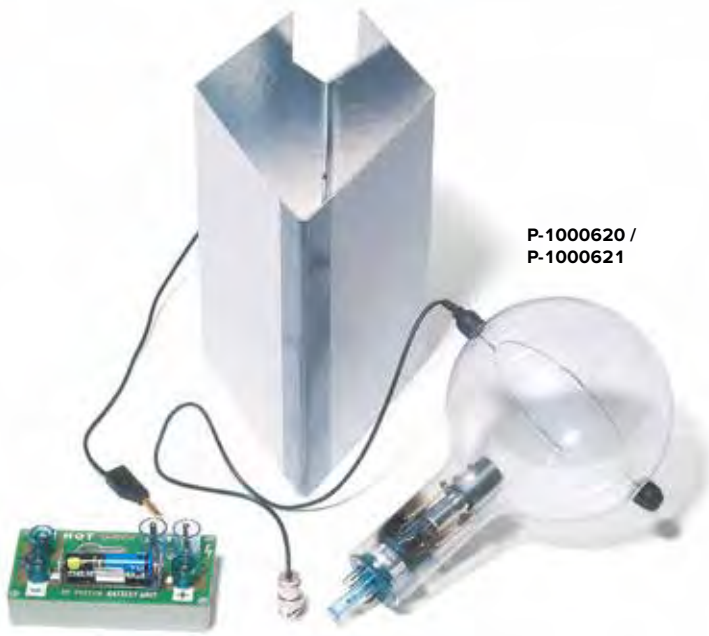

P-1000620 /
P-1000621

P-1008506
P-1000633



Gustav Hertz Experiment:

Gustav Hertz' experiment is a development of the Frack-Hertz experiment. Atoms are excited or even ionised by means of inelastic collisions with electrons inside an evacuated tube. If the kinetic energy of the electrons exactly matches a critical potential or ionisation level, the electrons transfer all their energy to the atoms and can then be drawn away to the collector ring in the tube with the help of a small voltage. At this point, the collector voltage reaches a maximum.

Critical Potentials Tube S

Hertz electron tube for quantitative investigations of inelastic collisions of electrons with inert gas atoms, determination of ionization energy of helium resp. neon, as well as resolution of the energy states of various primary and orbital angular-momentum quantum numbers. Includes shielding and battery unit for the collector voltage (battery not included).

Cathode filament

- voltage: $U_F \leq 7 \text{ V}$
- Anode voltage: $U_A \leq 60 \text{ V}$
- Anode current: $I_A \leq 10 \text{ mA}$
- Collector voltage: $U_C = 1.5 \text{ V}$
- Collector current: $I_C \leq 200 \text{ pA}$

Critical Potentials Tube S with He Filling

Critical potentials of helium:

- 2 ³S: 19,8 eV
- 2 ¹S: 20,6 eV
- 2 ³P: 21,0 eV
- 2 ¹P: 21,2 eV
- 3 ³S: 22,7 eV
- 3 ¹S: 22,9 eV
- 3 ³P: 23,0 eV
- 3 ¹P: 23,1 eV
- 4 ³S: 23,6 eV
- 4 ¹S: 23,7 eV
- Ionisation: 24,6 eV

P-1000620

Critical Potentials Tube S with Ne Filling

Critical potentials of neon:

- 2p⁵3s¹: 16,6 eV
- 2p⁵3p¹: 18,4 eV
- 2p⁵4s¹: 19,7 eV
- 2p⁵4p¹: 20,3 eV
- 2p⁵4d¹: 20,6 eV
- Ionisation: 21,6 eV

P-1000621

Control Unit for Critical Potentials Tubes

Control unit for operating the critical potentials tubes. Equipped with an output for sawtooth acceleration voltages; adjustable upper and lower limits of the acceleration voltage. Integrated pico-ammeter amplifier for anode current measurement. Allows recording of the acceleration voltage as a function of the anode current. A slow sawtooth voltage (approx. 6 seconds per cycle) is available with an interface or XY-recorder; a sawtooth voltage with a repetition rate of 20 Hz is available for oscilloscopic observations. Includes plug-in power supply.

Input:

Anode current measurement via a BNC jack

Outputs:

- Tube: Sawtooth acceleration voltage of 0 – 60 V, 20 Hz
- Fast: Voltage signal of 0 – 1 V, proportional to the acceleration voltage, for oscilloscopic observations
- Slow: Voltage signal of 0 – 1 V proportional to the acceleration voltage, for recording data with an XY-recorder or interface
- Anode current: Voltage signal of 0 – 1 V proportional to the anode current (1 V/nA)
- Supply voltage: 12 V AC
- Dimensions: approx. 170x105x45 mm³

Control Unit for Critical Potentials Tubes (230 V, 50/60 Hz)

P-1008506

Control Unit for Critical Potentials Tubes (115 V, 50/60 Hz)

P-1000633

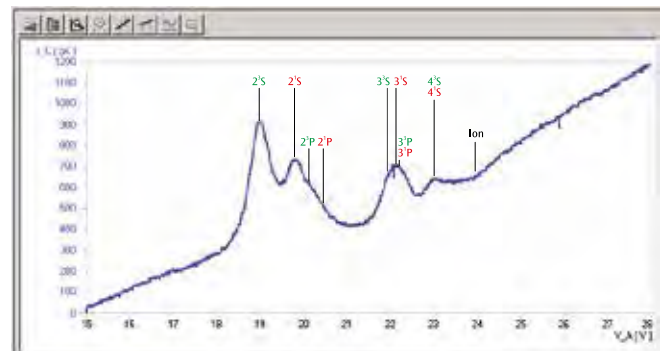

Collector current I_R as a function of accelerating voltage U_A . Gas filling: He.



UE5020500
PDF online



Experiment set-up with the control unit for critical potentials tubes

Experiment set-up with the control unit for critical potentials tubes

Additionally required:

- P-1014525** Tube Holder S
- P-1008506** Control Unit for Critical Potentials Tubes (230 V, 50/60 Hz)
- P-1003312** DC-Power Supply 0 – 20 V, 0 – 5 A (230 V, 50/60 Hz)

or

- P-1000633** Control Unit for Critical Potentials Tubes (115 V, 50/60 Hz)
- P-1003311** DC-Power Supply 0 – 20 V, 0 – 5 A (115 V, 50/60 Hz)

Additionally recommended:

- P-1002785** Digital-Multimeter P3340
- P-1017264** USB Oscilloscope 2 x 50 MHz
- P-1002748** HF Patch Cord, BNC/4 mm Plug (2x)
- P-1002843** Set of 15 Safety Experiment Leads 75 cm

Experiment set-up with the control unit for the Franck-Hertz experiment

Additionally required:

- P-1014525** Tube Holder S
 - P-1012819** Control Unit for the Franck-Hertz Experiment (230 V, 50/60 Hz)
- or
- P-1012818** Control Unit for the Franck-Hertz Experiment (115 V, 50/60 Hz)

Additionally recommended:

- P-1017264** USB Oscilloscope 2 x 50 MHz
- P-1002748** HF Patch Cord, BNC/4 mm Plug (2x)
- P-1002843** Set of 15 Safety Experiment Leads 75 cm



Experiment set-up with the control unit for the Franck-Hertz experiment



Experiment set-up for transmissive illumination of sodium fluorescence tube with a beam of white light



Experiment Topics:

- Sodium resonance fluorescence
- Absorption of Na spectral lines in a sodium mist



Absorption of white light (left) and yellow sodium light (right) in a glass tube containing sodium vapour. In each case, the light is dispersed far enough for it to pass unobstructed to the left and right of the tube.

Sodium Fluorescence Tube on Furnace Wall

Highly evacuated glass tube containing multiply distilled sodium for demonstrating the resonance fluorescence of sodium vapour. Filled with argon. The tube is heated in the furnace up to temperatures of between 180°C and 200°C in order to achieve sufficient pressure of sodium vapour. The entire tube emits yellow light at the wavelength of the sodium D line when it is brought to the heated state and illuminated with sodium spectral light. The sharply defined sodium D line appears in the spectrum. If it is instead illuminated with white incandescent filament light, the transmitted light exhibits a dark absorption line at the position of the sodium D line. Absorption can be demonstrated even without the use of a spectrometer due to the clear shadow formed when yellow sodium light passes through the tube.

Dimensions of tube: 170 mm x 42 mm diam.

Dimensions of hotplate: 230x160 mm² approx.

Weight: 550 g approx.

P-1000913

Additionally required:

P-1012820 Heating Chamber (230 V, 50/60 Hz)

or

P-1006796 Heating Chamber (115 V, 50/60 Hz)

Additionally recommended:

P-1003541 Sodium Vapour Spectrum Lamp

P-1003196 Choke for Spectrum Lamps (230 V, 50/60 Hz)

or

P-1003195 Choke for Spectrum Lamps (115 V, 50/60 Hz)

P-1003188 Optical Lamp, Halogen

P-1000593 Transformer 12 V, 60 VA (230 V, 50/60 Hz)

or

P-1006780 Transformer 12 V, 60 VA (115 V, 50/60 Hz)

P-1002835 Tripod Stand, 150 mm

P-1003022 Convex lens on stem, 50 mm

P-1001045 Barrel Foot, 0.9 kg

P-1003531 Hand Held Spectroscope with Amici Prism



Observation of sodium vapour in yellow sodium light



P-1012820
P-1006796

Heating Chamber

Electric heating chamber with continuous temperature control and digital temperature display showing actual and set-point temperatures. In lacquered metal housing with two viewing windows, opening with spring-clip for thermometer and thermally insulated carrying handle. Temperature measurement and control is handled by an integrated microcontroller and a Pt100 thermocouple.

Dimensions of

front opening: 230x160 mm² approx.

Heating power: 400 W

Maximum temperature: 300°C (230 V, 50/60 Hz)

250°C (115 V, 50/60 Hz)

Temperature constancy: ±1°C approx.

Dimensions: 335x180x165 mm³ approx.

Weight: 5.6 kg approx.

Heating chamber
(230 V, 50/60 Hz)

P-1012820

Heating chamber
(115 V, 50/60 Hz)

P-1006796

Experiment Topics:

- **Properties of X-rays:**
 - Transmission
 - Linear propagation
 - Ionisation
 - X-ray photography
- **Fluorescent radiation**
- **Shielding of X-rays**
- **Absorption experiments**
- **Distance law**
- **Dosimetry and radiation protection**
- **Diffraction of X-rays:**
 - Laue's recordings
 - Debye-Scherrer's recordings
 - Bragg's reflection
 - Duane-Hunt's displacement law (h-determination)
- **Moseley's law**

X-Ray Apparatus

The experiment chamber is contained in a closed, radiation-proof housing with a transparent synthetic-glass shield. If the synthetic-glass shield is opened, the high-voltage source for the X-ray tube is deactivated automatically. The high-vacuum X-ray tube with a directly heated tungsten cathode and copper anode is positioned in a borosilicate glass chamber with a thin-walled, concave ray emission window. A lead-glass hood with a collimator causes X-rays to emerge in parallel with the experiment plane and provides a shield against scattered radiation. The horizontal counter-tube goniometer consists of a central sample holder and a swiveling arm. In the form of a slide tray, this arm serves as a mount for the Geiger-Müller tube (P-1000661), ionisation chamber (P-1000668) as well as experimental devices in slide format or on a 5x5 cm base plate (for example, from P-1000665, P-1000666, P-1000667). The swiveling arm can be rotated manually independently of the sample holder, or at a fixed mutual angle with a ratio of 2:1, for instance, for experiments involving Bragg's reflection. The device is equipped with angle and millimeter scales, position markings for experimental devices, as well as radiation-proof bushings for cables and hoses. Including one cable to measure the tube current.

Anode voltage:	20/30 kV, switchable and electronically stabilised
Emission current:	0 to 80 μ A, continuously adjustable and electronically stabilised
Cathode heating:	4 V, 1 A
Focal spot:	5x1 mm ²
Anode material:	Cu
Lead-glass collimator:	radiation emission aperture with 5 mm diam.
Ray divergence:	better than 10°
Characteristic radiation wavelength:	Cu-K _{α} : 154 pm, Cu-K _{β} : 138 pm
Cable to measure tube current:	approx. 50 cm, 2.5 mm jack / 4 mm plugs (red / black)

Counter-tube goniometer:

Swiveling ranges:	0°, +10° to +130° and -10° to +130° relative to the ray axis
Angular coupling:	independent of the sample holder or with a ratio of 2:1
Measurement accuracy of Bragg's angle:	5 arc minutes
Timer:	0 to 55 minutes, continuously adjustable
Power consumption:	100 VA

Dimensions:

X-ray apparatus:	approx. 250 mm x 370 mm diam.
X-ray tube:	approx. 100 mm x 32 mm diam.
Weight:	approx. 9 kg

X-Ray Apparatus (230 V, 50/60 Hz)

P-1000657

X-Ray Apparatus (115 V, 50/60 Hz)

P-1000660

Spare Tube for X-Ray Apparatus (not shown)

Spare tube with Cu anode for X-ray apparatus (P-1000657) and X-ray apparatus (P-1000660).

P-1000664



P-1000657
P-1000660

Motor Drive Debye-Scherrer (230 V, 50/60 Hz)

For structural investigations using the rotating-crystal method, suitable for the Debye-Scherrer camera (contained in P-1000665). Power transmission via bevel gears. Power consumption: 3 VA

P-1019216



Recommended for operation at a mains supply voltage of 100 – 120 V (not shown):

Voltage Transformer 120 V / 230 V

P-1003649

P-1019216

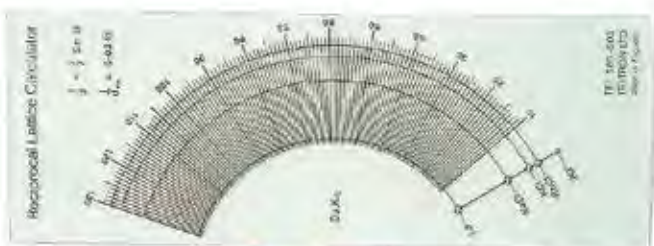

P-1000666



Crystallography Accessories

These accessories for the basic equipment set (P-1000665) are intended for additional crystallographic experiments as well as treatments of Moseley's law, the Debye-Scherrer method, Bragg's reflection and material tests.

Contents:

- 4 foils, Fe, V, Mn, Cr
- 2 single crystals, KCl, RbCl
- 5 powder samples, NaF, SiC, NH₄Cl, MgO, Al
- 2 wire samples, Al, Nb (3x each) for Debye-Scherrer experiments
- 10 polyethylene threads
- 1 disc for calculating Bragg's angle

P-1000666

Radiography Accessories

These accessories for the basic equipment set (P-1000665) are intended for investigating the following topics: scattering, absorption; dependence on acceleration voltage, emission current and penetration power, resolving power; shielding, half width; exposure time, non destructive materials testing.

Contents:

- 1 Maltese cross
- 1 phantom
- 1 pin diaphragm
- 1 aluminium layer, stepped
- 5 aluminium absorbers, 0.1/0.25/0.5/1.0/2.0 mm
- 1 lead absorber, 0.5 mm
- 1 plastic absorber
- 2 magnets
- 4 materials testing models (porosity, fissures, welding seam, painting)

P-1000667



P-1000667

Geiger-Müller Tube T

Self-extinguishing halogen-trigger counter tube for registering alpha, beta, gamma and X-radiation. Enclosed in a plastic housing with a holder for mounting on the swiveling arm of the X-ray apparatus (P-1000657 or P-1000660); equipped with a firmly installed BNC patch cord. Includes a retention clip for other types of mounting. Dose-rate range: $10^{-3} - 10^2$ mGy/h
 Mass of the active surface: Mica: 2.0 – 3.0 mg/cm²
 Operating voltage: 500 V
 Dimensions: approx. 50 mm x 50 mm x 22 mm diam.
 Cable length: approx. 1 m

P-1000661



Basic Set Bragg

Basic equipment set for Bragg's reflection experiment with a LiF and a NaCl crystal.

Contents:

- 1 slit diaphragm collimator, 1 mm
- 2 slit diaphragms, 1 mm/3 mm
- 2 single crystals, LiF, NaCl
- 1 Geiger Müller tube (P-1000661)

P-1008508

Basic Equipment Set

Equipment set for qualitative and quantitative experiments involving, for instance, linear propagation and quantitative experiments involving, for instance, linear propagation, ionisation, penetration capacity of X-radiation and X-ray photography; also for demonstrating the wave nature of X-radiation, investigating fluorescent X-radiation and determining mass-absorption coefficients. In a specially moulded storage box.

P-1000665

Contents:

- 1 fluorescent screen
- 1 Debye-Scherrer camera
- 2 film cassettes
- 1 lead mask
- 2 plate electrodes on a 4 mm contact pin
- 1 slit diaphragm collimator, 1 mm
- 1 pin diaphragm collimator, 1 mm diam.
- 1 ancillary magazine with a circular aperture
- 2 slit diaphragms, 1 mm/3 mm
- 1 pin diaphragm, 9.5 mm diam.
- 2 single crystals, LiF, NaCl
- 2 mini crystals, LiF
- 1 powder sample, LiF
- 10 copper wires
- 4 absorption foils, Ni, Cu, Co, Zn
- 1 scattering-foil revolver, coated with V, Cr, Mn, Fe, Co, Ni, Cu, Zn
- 1 set of assembly aids (acetate adhesive, clips)
- 1 storage box, specially moulded





UE7010100
PDF online

Bragg Driver

The Bragg driver is a combination of hardware and software which allows the user to collect X-ray diffraction data in combination with the X-ray apparatus (P-1000657 or P-1000660). It provides the high voltage and counting circuitry for the Geiger Müller tube (P-1000661) and includes a software program that allows the user to control the driver and collect data. It includes the USB powered drive, a drive gear, an USB cable and a powder compressor. Scans can be obtained for all crystals available in the basic equipment set (P-1000665) and the crystallography accessories (P-1000666). An additional feature includes the ability to scan powders and foils. The software allows selection of scan angles, resolution, and time per step. Once the experiment is completed the software permits zoom-in on the data and the facility to add comments to the file. Data can be exported to a spreadsheet for further analysis.



Time interval for automatic data saving: 30 s
 Angular range: 12° – 120°
 Time per step: ≥ 0.1 s
 Angular step: ≥ 0.05°
 GM tube voltage: 0 – 1000 V

P-1012871

P-1012871



Recommended equipment:

Art. No.		Basic	Intermediate	Advanced
P-1000657 or P-1000660	X-ray Apparatus	yes	yes	yes
P-1000661	Geiger Müller Tube T	yes	yes	yes
P-1012871	Bragg Driver	yes	yes	yes
P-1000665	Basic Equipment Set	yes	yes	yes
P-1000666	Crystallography Accessories		yes	yes
P-1000667	Radiography Accessories			yes
P-1019216	Motor Drive		yes	yes
P-1000669	Filmpack2	yes	yes	yes
P-1000670	Filmpack 4	yes	yes	yes

X-Ray Apparatus

Basic:

Basic experiments using photographic techniques and Geiger Müller tube like Laue experiments, Bragg diffraction experiments, experiments on inverse square law, emission, rectilinear propagation, penetration and absorption of X-rays.

Intermediate:

Basic experiments and experiments on Moseley, Debye-Scherrer diffraction, size of the unit cell in salt crystals in addition.

Advanced:

Intermediate experiments and experimental investigations into radiography, film and the properties of x-rays in addition.

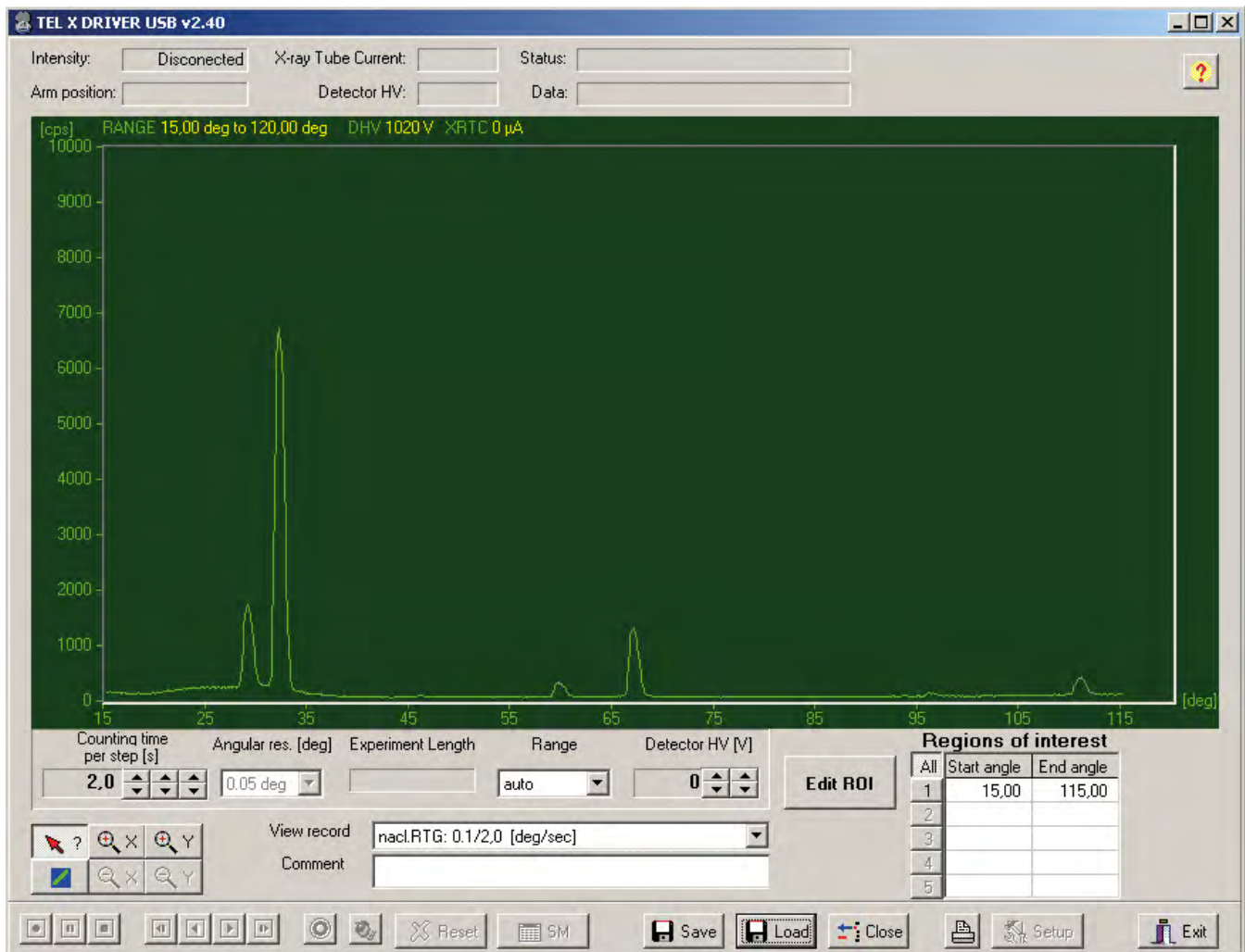

Bragg curve for LiF

Atomic and Nuclear Physics

X-ray Energy Detector

X-ray detector for recording energy spectra of X-rays or γ radiation in the energy range of approx. 2 keV to 60 keV. It mainly consists of a Si-PIN photodiode which is integrated in a metal housing together with a charge sensitive preamplifier, a main amplifier with pulse shaping and a digital signal processing circuit. The detector holder is particularly designed for installation on the swiveling arm of the X-ray apparatus (P-1000657 or P-1000660). The power supply is ensured via the USB port of a PC. Including CD with measuring and evaluation software for PC.

Energy range:	approx. 2 keV up to 60 keV
Energy resolution (FWHM):	0.55 keV at $E_{FeK\alpha} = 6.40$ keV
Entrance window:	Plastics (absorption equivalent to Graphite with $d = 40 \mu\text{m}$)
Detector:	Si-PIN photo diode
Active Area:	0.8 mm diam.
Thickness:	approx. 200 μm
Dead time per pulse:	approx. 200 μs
Connection:	USB
Cable length:	1.75 m
Dimensions:	80 mm x 22 mm diam.
Mass:	150 g

P-1008629

Additionally required:

P-1000657 X-Ray Apparatus (230 V, 50/60 Hz)

or

P-1000660 X-Ray Apparatus (115 V, 50/60 Hz)

Additionally recommended:

P-1012868 Set of Fluorescence Samples

Experiment Topics:

- X-ray energy spectroscopy
- Compton effect
- X-ray fluorescence spectroscopy
- Absorption experiments
- Bragg's reflection
- Duane-Hunt's displacement law
- Moseley's law

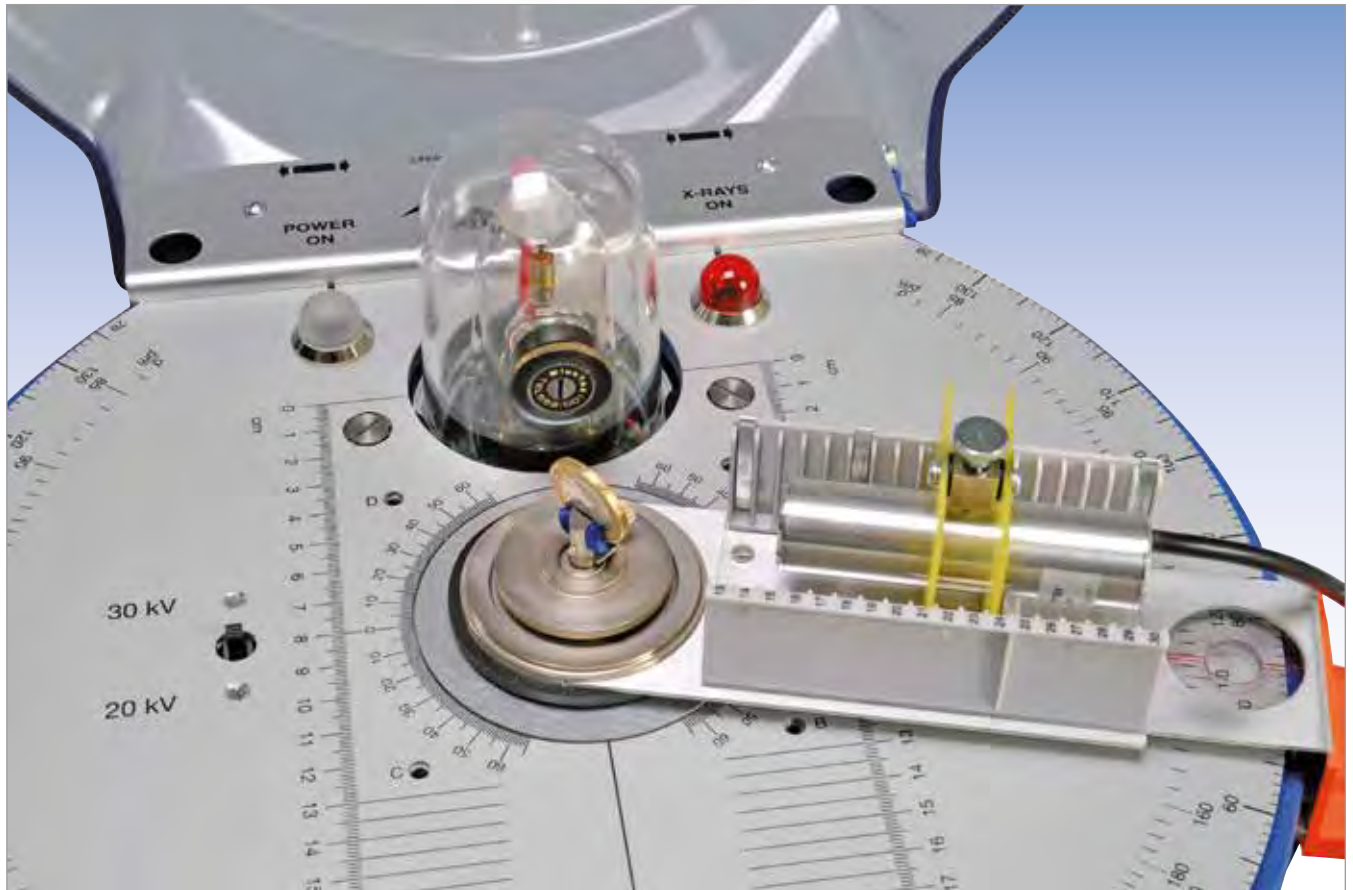

Simplified energy band diagram for an atom with characteristic X-ray lines

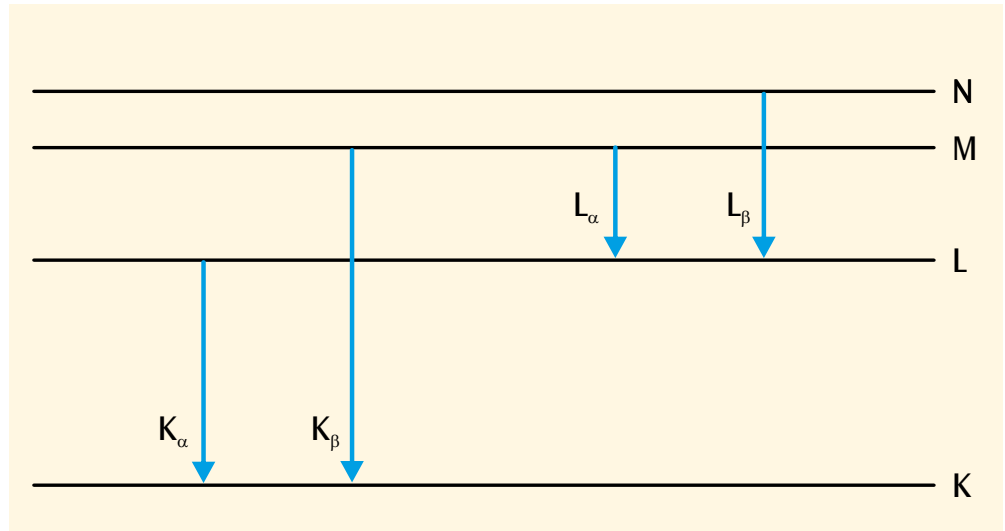

X-ray fluorescence spectrum for a one euro coin

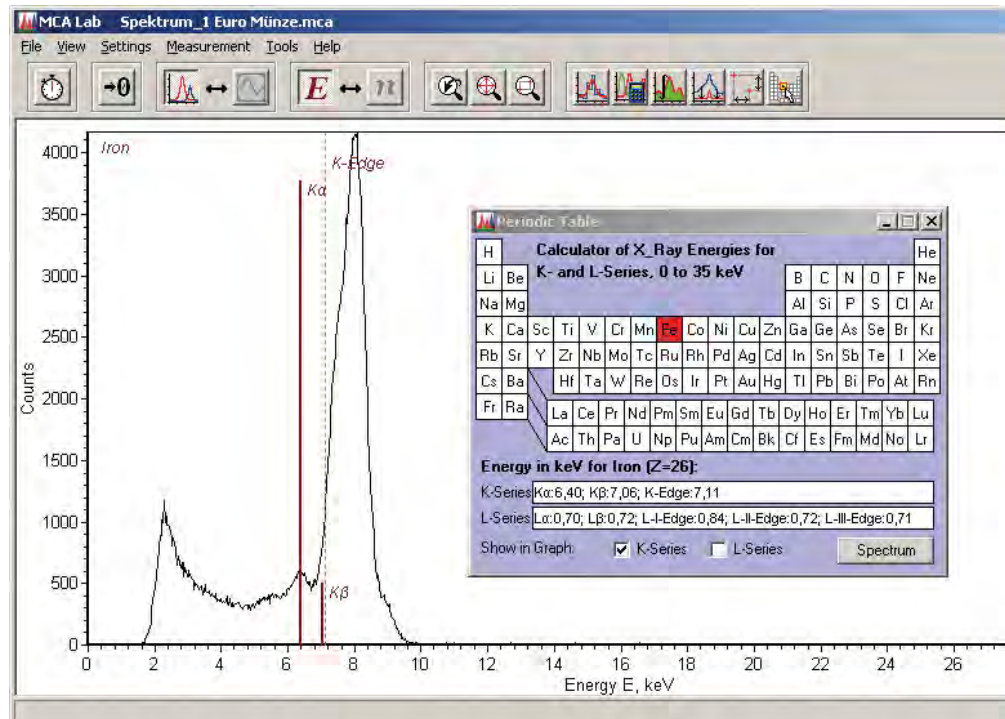

X-ray fluorescence spectra for wrought iron (red) and stainless steel (black)

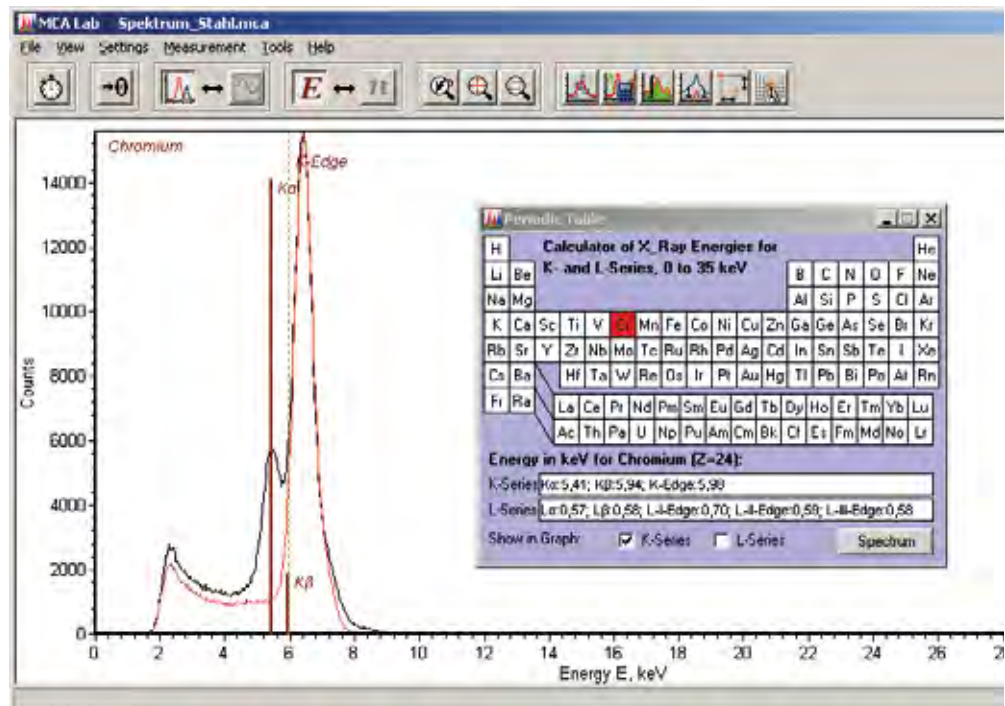

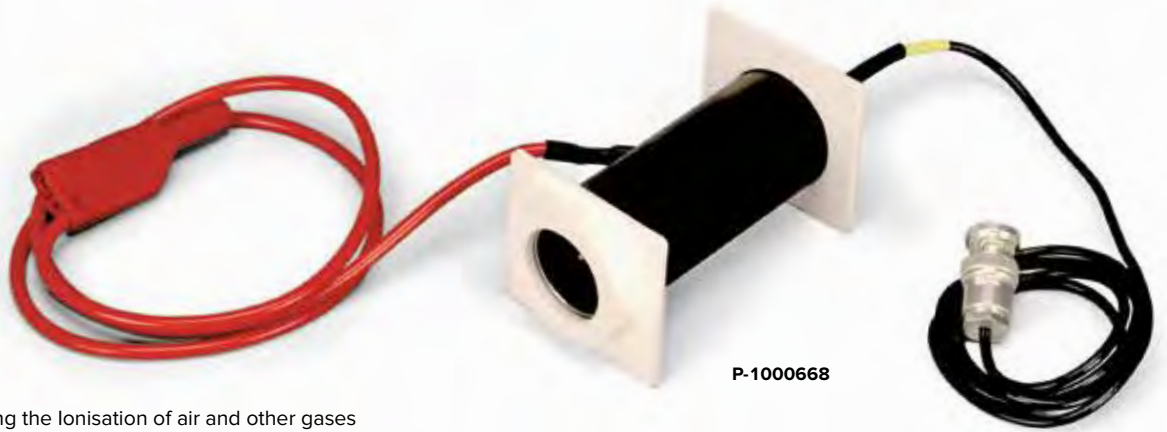

P-1000668

Ionisation Chamber

Intended for investigating the ionisation of air and other gases brought about by X-radiation at different pressures (saturation characteristics, model of a Geiger-Müller tube, dosimetry). Possesses a cylinder-shaped cathode, rod-anode and hose shaft for evacuating and introducing gases.

- Operating voltage: max. 2 kV
- Ionisation current: $10^{-11} - 10^{-10}$ A
- Rod-electrode: approx. 75 mm long
- Chamber: approx. 85 mm x 25 mm diam.
- Hose shaft: approx. 5 mm diam.

P-1000668

Additionally required:

- P-1003310 High Voltage Power Supply 5 kV (230 V, 50/60 Hz)** and **P-1001025 Electrometer (230 V, 50/60 Hz)** or
- P-1003309 High Voltage Power Supply 5 kV (115 V, 50/60 Hz)** and **P-1001024 Electrometer (115 V, 50/60 Hz)**
- P-1006813 Electrometer Accessories**
- P-1003073 Analogue Multimeter AM50**
- P-1002751 Adaptor BNC/Jack 4-mm-Plugs**
- P-1002849 Pair Safety Experiment Leads, 75 mm**



Filmpack 2

Highly sensitive film (38x35 mm²) for α -, β - and X-radiation. Single packaging in opaque plastic cases allows development and fixing in daylight (duration: approx. 6 minutes).

Contents:

- 20 film sheets (38x35 mm²) in light-tight plastic cases
- 1 bottle of X-ray developer
- 1 bottle of X-ray fixer
- 1 syringe with a cannula for introducing chemicals into the film cases
- 1 metal clip

P-1000669

Set of Fluorescence Samples

Set of 7 samples for material analysis with the X-ray energy detector (P-1008629). The material composition can be determined from the energies of the appropriate X-ray fluorescence lines. Thus, for example the difference between stainless and low carbon steel, or between copper, brass and bronze can be seen clearly.

Materials:

Stainless Steel S321, Low Carbon Steel, Copper C101, Brass C260, Bronze C220, Zinc and Lead.

P-1012868



P-1012868

Filmpack 4

Like P-1000669, but consisting of 12 film sheets, 150x12 mm², in light-tight plastic cases for a Debye-Scherrer camera.

P-1000670



P-1000669

P-1000670

Geiger-Müller Counter Tube

Self-quenching halogen pulse ionisation chamber for detecting alpha, beta, gamma and x-ray radiation. In metal housing with mica window, removable mounting clamp with shaft. Long plateau length.

Filling:	Neon/argon mixture, halogen as quenching agent
Cathode dimensions:	approx. 39x14 mm ²
Window:	mica, 9 mm diam.
Mass per unit area:	1.5 – 2.0 mg/cm ²
Plateau length:	400 V – 600 V
Operating voltage:	400 – 600 V (recommended: 500 V)
Relative plateau slope:	0.04 %/V
Dead time:	90 µs
Limiting resistor:	10 MΩ, integrated in holder
Shaft:	approx. 100 mm x 10 mm diam.
Dimensions counter tube:	approx. 85 mm x 25 mm diam.
Weight:	approx. 160 g

P-1001035

Additionally required:

P-1002746 HF Patch Cord, 1 m

**P-1001033 Digital Counter
(230 V, 50/60 Hz)**

or

**P-1001032 Digital Counter
(115 V, 50/60 Hz)**



P-1001035

Digital Counter

Digital counter/timer for measuring duration of motion, transition times, periods, pendulum periods and frequencies, as well as for counting events or Geiger tube pulses. Includes a speaker that can be turned on and off, power supplies for direct connection to light barriers (P-1000563) or for powering a Geiger-Müller counter (P-1001035). For event counting, a fixed counting period can be programmed in a range from 1 s to 99999 s. Counter events (start, stop) can either be triggered by a signal to the input sockets or manually via switches. Includes plug-in power supply.

Time measurement:	0.1 ms – 99999 s
Resolution:	0.1 ms / 1 ms / 0.1 s
Frequency measurement:	1 – 100 kHz, where voltage > 1.5 V _{pp}
Resolution:	1 mHz (1 – 100 Hz), 1 Hz (1 – 100 kHz)
Counting periods:	1/10/60/100 s or manually triggered
Input A:	miniDIN 8 socket, 4 mm safety sockets
Input B:	miniDIN 8 socket, 4 mm safety sockets
Input voltage A:	0.5 V – 15 V AC
Input voltage B:	1 V – 15 V AC
Active edge	Rising/falling
Counter tube input:	BNC socket
Power supply:	550 V / 1 MΩ
Display:	5-digit LED display
Operating voltage:	9 – 12 V DC via plug-in power supply
Dimensions:	250x100x160 mm ³ approx.
Weight:	0.8 kg approx.

Digital Counter (230 V, 50/60 MHz)

P-1001033

Digital Counter (115 V, 50/60 MHz)

P-1001032



P-1001033
P-1001032

P-1002722



Geiger Counter

Versatile, easy to use and compact precision instrument for measuring α-, β- and γ-radiation. With filter selection switch at the front of the Geiger-Müller counter tube for filtering out types of radiation (γ/β, γα/β or γ only), large display and integrated USB interface. Including USB cable, Windows software, and operating instructions. The following functions and operating modes are available for measurement:

- Standard mode for displaying the current radiation level. Display of the equivalent dose as a numerical value and as bar chart and display of the time until a selected cumulative dose limit is reached (default 5 µSv/h). Also equipped with variable acoustic and optical warning threshold signal and display of average radiation from previous day.
- Pulse counting either permanent or with variable gate time. Gate time adjustable in seconds, minute or hours. Additional optional acoustic count indication.
- Count rate measurement. The pulses registered are measured successively and converted into a count rate (number of pulses per second).
- Integrated display of date and time for correct recording of measured radiation.
- The number of pulses registered is stored in the internal memory. This facilitates recording e.g. of weekly values for up to 10 years.
- Computer docking station. The software enables the measured data to be evaluated and processed on an MS-Windows PC.

Radiation types:	α from 4 MeV, β from 0.2 MeV, γ from 0.02 MeV
Measured variables:	equivalent dose in Sv/h, mSv/h, µSv/h pulses/s, pulses/variable time interval
Display:	LCD, 4 digit, numerical with display of measured variable, quasi analogue bar chart, operating mode indicators
Radiation detector:	End window Geiger-Müller counter tube, stainless steel housing with neon-halogen filling
Measuring length:	38.1 mm
Measuring diameter:	9.1 mm
Mica window:	1.5 – 2 mg/cm ²
Gamma sensitivity:	114 pulses/min for ⁶⁰ Co radiation = 1 µSv/h in background radiation energy band
Background rate:	10 pulses per minute approx.
Internal memory:	2 kilobytes
Battery life:	3 years approx.
Dimensions:	163x72x30 mm ³ approx.
Weight:	155 g approx.

P-1002722

Important note:

In accordance with radiation protection regulations, anyone who works with radioactive materials or ionising radiation or plans to do so has the following obligations:

- Avoid unnecessary exposure to radiation or contamination of persons or of the environment.
- Ensure that any unavoidable exposure to radiation or contamination of persons or of the environment is below the limits specified by the regulations and is reduced to the minimum that is possible with present science and technology, taking into account all the circumstances of the case.



Dosimeter Radex RD 1706

Used for determining dose rates in $\mu\text{Sv/h}$ for β -, γ - and X-rays, this radiation meter can be operated by non-professionals while nonetheless offering the features of a professional dosimeter. Including two built-in Geiger-Müller counter tubes and a large, illuminated LCD display. The device measures the activity of β - and γ -particles and uses the results to calculate the dose rate. Depending on dose rate, the measurement and calculation times vary from 26 s to 1 s at high dose rates. Detection of each particle is indicated by an audio signal to facilitate searching for radioactive sources. The difference between the mean dose rate and background radiation level, as well as the background radiation level itself are displayed in the "background" mode. This facilitates, for example, inspections of enclosed spaces and building materials. Overshoot of an adjustable alarm threshold can be indicated either by an audio signal or a vibration signal. Measured values remain saved after the device has been turned off.

Counters:	Two GM counter tubes SBM20-1
Measurement variable:	Ambient equivalent dose rate $H^*(10)$
Measuring range:	0.05 – 999.0 $\mu\text{Sv/h}$
Alarm threshold:	Adjustable from 0.10 to 99.0 $\mu\text{Sv/h}$
Alarm:	Audio or vibration signal
Measurement and calculation times:	26 s
	1 s (at $H^*(10) > 3.5 \mu\text{Sv/h}$)
Value display duration:	Continuous
Energy detection range	
X-radiation and γ -radiation:	0.03 to 3.0 MeV
β -radiation:	0.25 to 3.5 MeV
Batteries:	1.5 V, AAA (1 x or 2 x)
Operating time:	500 h, with 2 batteries (1350 mAh) under normal conditions
Dimensions:	105x60x26 mm ³
Weight (without batteries):	90 g

P-1012894

Spinthariscopes

Detection instrument for observing scintillations produced by radioactive decay. When a radiation cartridge (^{226}Ra , 4 kBq, P-1006797) is screwed into the instrument so that its radiation outlet is directed downwards onto the exposed zinc sulphide screen, it is possible to look through the eyepiece of the instrument in total darkness and observe the random light flashes that are caused by radioactive decay. Screen: 15x15 mm²

P-1000918

Additionally required:

P-1006797 Radiation Cartridge, ^{226}Ra , 4 kBq

Cloud Chamber

Expansion cloud chamber for observing the paths of α -rays. Cover and sidewall are of plexiglas. With threaded hole for inserting the ^{226}Ra , 4 kBq radiation cartridge (P-1006797), hinged absorption foil for opening and closing the beam outlet and carrying handle at the side. By compressing the attached rubber ball and then allowing it to expand, a supersaturated methanol-water mixture is produced in the cloud chamber. Following that, the paths of the α -rays revealed by droplet formation are visible for 1 – 2 seconds in the light of an optical lamp.

P-1000921

Additionally required:

P-1006797 Radiation Cartridge, ^{226}Ra , 4 kBq

Radiation Cartridge, ^{226}Ra , 4 kBq

Regulation-exempt radiation source with brass container for shielding. Radium sulphate rolled in gold foil and sealed at one end of a stainless steel cartridge.

Activity:	4 kBq
Weight:	400 g approx.

P-1006797

Note:

In Germany, the ^{226}Ra radiation cartridge is authorised for unlimited use. Its activity is approximately 4 kBq, whereas the limit for unlimited use of ^{226}Ra is around 10 kBq. The ^{226}Ra radiation cartridge can be used on its own in Germany without any authorisation or notice as long as the so-called "sum rule" is adhered to. Otherwise, it is necessary to obtain authorisation from the appropriate authority. The "sum rule" states that the percentage contribution from all samples or nuclides present must not exceed 100% of the authorised limits. Such a limit may be exceeded if as many as three ^{226}Ra radiation cartridges or even a small number of other samples or nuclides are present. In other countries, it is necessary to observe the legal regulations stipulated there.

Caution: Hazardous item. For this reason there will be additional transport costs.



Nal(Tl) Scintillation Detector

An energy-sensitive detector for identifying γ -ray and X-ray fluorescent radiation with high probability. It can record energy spectra, which can be calibrated, and measure the relative intensity of the radiation. Incoming radiation causes a thallium-doped sodium iodide crystal to emit brief pulses of light, which are then converted into electrical pulses in proportion to the energy of the radiation by means of a photomultiplier affixed to the apparatus. The crystal is protected against light penetrating from outside by a thin aluminium cover. The photomultiplier is protected from interference by external magnetic fields by means of mu-metal shielding.

Relative energy resolution: 8% approx. at 662 keV
 Connector socket: 14-pin, with centring aid
 Dimensions of crystal : 51 mm x 51 mm diam. approx.
 Aluminium cover: 0.5 mm approx.
 Overall dimensions 185 mm x 58 mm diam. approx.

P-1008707

Additionally required:
P-1008708 Nal Operating and Evaluation Unit

Additionally recommended:
P-1006797 Radiation Cartridge, ^{226}Ra , 4 kBq



Nal Operating and Evaluation Unit

Complete apparatus for operation and evaluation, designed for measurement and comprehensive evaluation of energy spectra. Consists of a 14-pin connector stage with a high-voltage power supply for the photomultiplier of an Nal(Tl) scintillation detector. Possesses an integrated amplifier with pulse-shaping capability and digital signal processing for four-channel analysis. The power supply for the complete unit is provided via the USB port of a PC. Includes MAESTRO 32 measurement and evaluation software for a PC. The measurement and evaluation software has a versatile graphic user interface, supports identification of the measured radiation energies with the aid of integrated libraries and allows for the setting of all measurement parameters, including the high-voltage supply, from the PC.

Resolution: 1024 channels
 Amplification: 1, 3 or 9 (coarse) 0.4 – 1.2 (fine)
 Integral non-linearity: <0.05% over 99% of the range
 Differential non-linearity: <1% over 99% of the range
 Effect of lag: <5% for less than 50000 events per second
 High-voltage supply: 0 to 1200 V DC
 Amplifier drift: <0.15x10⁻³ per °C
 Offset drift: <0.05x10⁻³ per °C
 Pulse shaping: 0.75 – 2 μs

P-1008708

Additionally required:
P-1008707 Nal(Tl) Scintillation Detector

Warning Notice: "Radioactive"

Warning notice on white plastic. On stem.
 Dimensions: 210x300 mm² approx.
 Weight: 80 g approx.

P-1000919

Steel Safe for Radioactive Materials

Steel safe for theft proof storage of radioactive materials in accordance with radiation protection requirements.
 Dimensions: 140x300x360 mm³ approx.
 Weight: 3 kg approx.

P-1000920

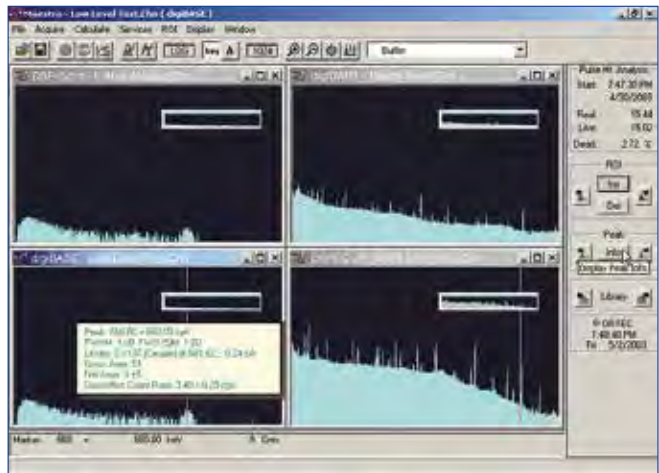

Screenshot of the measurement and evaluation software MAESTRO 32



ESR/NMR Basic Set

This basic equipment set is intended for investigating the electron spin resonance (ESR) of an unpaired electron of a DPPH sample as well as the nuclear magnetic resonance (NMR) of glycerine, teflon and polystyrene. Resonances are observed via transitions induced through high frequencies resulting from changes in the external magnetic field. Resonance absorption curves can be represented with a simple dual-channel oscilloscope or with the 3B NET/log™ unit.

Contents:

- 1 Basic unit
- 1 Pair of coils
- 1 Control panel
- 1 Plug-in power supply, 12 V AC (230 V, 50/60 Hz)
- or
- 1 Plug-in power supply, 12 V AC (115 V, 50/60 Hz)

The basic unit is a mechanical base for test samples as well as ESR (from P-1000640) or NMR probes (from P-1000642), a coil pair and a permanent magnet (from P-1000642).

Dimensions: 165x105x135 mm³ approx.
Weight: 1.25 kg approx.

The coil pair is used to generate the variable magnetic field for electron spin resonance and – in conjunction with the permanent magnet (from P-1000642) – nuclear spin resonance.

Magnetic flux density: 0 – 3.7 mT
Connection: Barrel connector
Dimensions: 20 mm x 74 mm diam. approx. each
Weight: 0.2 kg approx. each

The control console provides the voltage for control and supply of power to probes and the coil pair. It also processes the signal for display on an oscilloscope and indicates the frequency of the high-frequency signal.

Probe connection: Four-pin Lemo socket
Coil pair connection: Saw-tooth current source, 0 – 250 mA, 50 ms, pair of barrel sockets
Field output: Proportional to coil current, 0 to 1 V, BNC socket
Signal output: Resonance signal, 0 to 1 V, BNC socket
Frequency range: 45 to 75 MHz approx. (ESR)
10 to 15 MHz approx. (NMR)
Dimensions: 170x105x45 mm³ approx.
Weight: 0.5 kg approx.

Experimental topics:

- Resonance absorption of a high-frequency oscillating circuit
- Dependence of resonance frequency on magnetic fields
- Line width
- Electron spin
- Magnetic moment of an electron
- Determination of the electron g factor
- Proton spin
- Magnetic moment of a proton and nucleus
- Determination of the nucleus g factor
- Nuclear-spin tomography

ESR/NMR Basic Set (230 V, 50/60 Hz)

P-1000638

ESR/NMR Basic Set (115 V, 50/60 Hz)

P-1000637

Additionally required:

P-1000640 ESR Supplementary Set

or

P-1000642 NMR Supplementary Set

P-1002727 Analogue Oscilloscope, 2x30 MHz

or

P-1000540 3B NET/log™ (230 V, 50/60 Hz)

or

P-1000539 3B NET/log™ (115, 50/60 Hz)



P-1000638
P-1000637

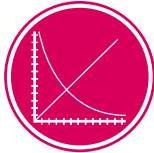

UE5030200
PDF online



NMR Supplementary Set

Supplementary set for ESR/NMR basic set (P-1000638 or P-1000637) for experiments on nuclear magnetic resonance using three different samples. Consists of an NMR probe-head with radio frequency coil, a permanent magnet giving a highly uniform field, a sample of glycerine, a sample of polystyrene, a sample of Teflon, an empty sample tube for comparison and two mounting discs.

Connection to the probe-head: Four-pin Lemo plug

Magnetic flux density of permanent magnet: 300 mT approx.

P-1000642



P-1000642

ESR Supplementary Set

Supplementary set for ESR/NMR basic set (P-1000638 or P-1000637) for experiments on electron spin resonance using DPPH. Consists of an ESR probe-head with radio frequency coil, a sample of DPPH (di-phenyl picryl hydrazyl), an empty sample tube for comparison, two mounting rings and two mounting cylinders.

Connection to the probe-head: Four-pin Lemo plug

P-1000640



P-1000640

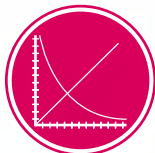

UE5030100
PDF online

P-1000640



P-1002727

P-1000638
P-1000637

Experiment topics:

- Hall effect in semiconductors
- Extrinsic conductivity
- Intrinsic conductivity
- Mobility of electrons and holes
- Drift velocity of charge carriers
- Carrier concentration
- Band separation

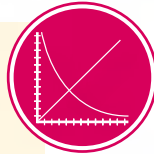

UE6020100
UE6020200
PDF online



Experiment set-up:
Hall effect in semiconductors

Basic Hall Effect Apparatus

Basic apparatus for providing contact, power supply and support to a germanium crystal on a circuit board (P-1008522, P-1009810 and P-1009760) in experiments on the Hall effect or on conductivity. Includes an integrated, adjustable constant current source to provide the current through the sample, a measuring amplifier with offset compensation for Hall voltages and heating to raise the crystal to as high as 170°C, also featuring temperature regulation and a switchable display showing Hall voltage, sample current, sample voltage or temperature. Hall voltage and sample voltage can be tapped directly from the front panel. In addition three equivalent voltage outputs for Hall voltage, sample current and sample temperature can be measured from the side. Includes an attachment for assembling the apparatus on the U-shaped core (P-1000979) of a transformer assembly kit and 2 connecting leads with 8-pin miniDIN plugs.

Outputs for

equivalent voltages: 4-mm safety sockets
8-pin miniDIN sockets (for 3B NET/og™)

Power supply: 12 V AC, 3 A via 4-mm sockets

Dimensions: 180x110x50 mm³ approx.

Weight: 0,5 kg approx.

P-1009934

N-Doped Germanium on Printed Circuit Board

High-quality interchangeable board with an n-doped germanium crystal for investigating the conductivity and Hall potential for n-doped germanium as a function of temperature. With contacts for transverse current and Hall potential, integrated resistive heating element with temperature sensor directly under the crystal, and multi pin plug for connecting the circuit board to the basic Hall effect apparatus (P-1009934).

Crystal dimensions: 20x10x1 mm³
approx.

Overall dimensions: 70x70x10 mm³
approx.

Weight: 30 g approx.

P-1009760

Additionally required:
P-1009934 Basic Hall Effect Apparatus

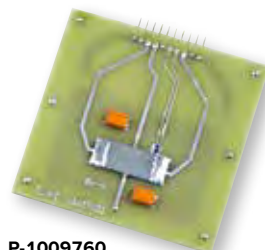

P-1009760



P-1009934

Undoped Germanium on Printed Circuit Board

High-quality interchangeable board with an undoped germanium crystal for investigating the conductivity of undoped germanium as a function of temperature. With contacts for transverse current, integrated resistive heating element with temperature sensor directly under the crystal, and multi pin plug for connecting the circuit board to the basic Hall effect apparatus (P-1009934).

Crystal dimensions: 20x10x1 mm³
approx.

Overall dimensions: 70x70x10 mm³
approx.

Weight: 30 g approx.

P-1008522

Additionally required:
P-1009934 Basic Hall Effect Apparatus

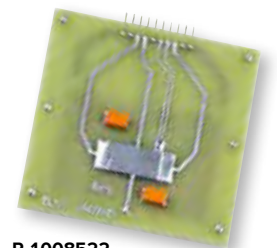

P-1008522

P-Doped Germanium on Printed Circuit Board

High-quality interchangeable board with an p-doped germanium crystal for investigating the conductivity and Hall potential for p-doped germanium as a function of temperature. With contacts for transverse current and Hall potential, integrated resistive heating element with temperature sensor directly under the crystal and multi pin plug for connecting the circuit board to the basic Hall effect apparatus (P-1009934).

Crystal dimensions: 20x10x1 mm³ approx.

Overall dimensions: 70x70x10 mm³ approx.

Weight: 30 g approx.

P-1009810

Additionally required:
P-1009934 Basic Hall Effect Apparatus

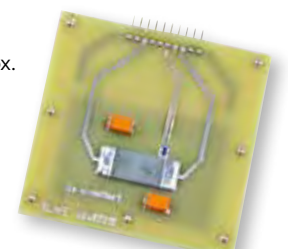

P-1009810

Experiment “Electrical Conduction in Semiconductors – Determine band separation in germanium”

- 1 Basic Hall Effect Apparatus P-1009934
- 1 Undoped Germanium on Printed Circuit Board P-1008522
- 1 Barrel Foot, 1000 g P-1002834
- 1 Transformer with Rectifier 3/ 6/ 9/12 V, 3 A (230 V, 50/60 Hz) P-1003316
- or
- 1 Transformer with Rectifier 3/ 6/ 9/12 V, 3 A (115 V, 50/60 Hz) P-1003315
- 1 Digital Multimeter P3340 P-1002785
- 1 Pair of Safety Experiment Leads, 75 cm P-1002849
- 1 Pair of Safety Experiment Leads, 75cm, red/blue P-1017718
- 1 3B NET/log™ (230 V, 50/60 Hz) P-1000540
- or
- 1 3B NET/log™ (115 V, 50/60 Hz) P-1000539
- 1 3B NET/lab™ P-1000544

Experiment “Hall-effect in p- and n-doped germanium”

- 1 Basic Hall Effect Apparatus P-1009934
- 1 N-Doped Germanium on Printed Circuit Board P-1009760
- 1 P-Doped Germanium on Printed Circuit Board P-1009810
- 1 Magnetic Field Sensor ±2000 mT P-1009941
- 1 Coil D with 600 turns P-1000988
- 1 U-core P-1000979
- 1 Pair of Pole Shoes and Clamping Brackets D for Hall Effect P-1009935
- 1 Transformer with Rectifier 3/ 6/ 9/12 V, 3 A (230 V, 50/60 Hz) P-1003316
- or
- 1 Transformer with Rectifier 3/ 6/ 9/12 V, 3 A (115 V, 50/60 Hz) P-1003315
- 1 DC Power Supply 0 – 20 V, 0 – 5 A (230 V, 50/60 Hz) P-1003312
- or
- 1 DC Power Supply 0 – 20 V, 0 – 5 A (115 V, 50/60 Hz) P-1003311
- 1 Digital Multimeter P3340 P-1002785
- 1 Set 15 Safety Experiment Leads 75 cm P-1002843
- 1 3B NET/log™ (230 V, 50/60 Hz) P-1000540
- or
- 1 3B NET/log™ (115 V, 50/60 Hz) P-1000539
- 1 3B NET/lab™ P-1000544

Experiment Topics:

- Hall effect in metals
- Normal and anomalous Hall effect
- Hall coefficient

Hall Effect in Metals

For verifying the existence of a Hall-effect voltage across a copper or zinc sample being supplied with a current I and located in a magnetic field acting perpendicular to the direction of the current. Ready-to-use samples are soldered onto a printed circuit board with 4-mm connection sockets. The Hall effect mounting is required in order to attach the sample within the magnetic field of an electromagnet.

- Thickness of copper sample: 17.5 μm
- Max. current through copper sample: 20 A DC
- Thickness of zinc sample: 25μm
- Max. current through zinc sample: 15 A DC
- Sample surface area: 10x44 mm²
- Dimensions: 130x90x25 mm³ approx.
- Weight: 45g approx.

Copper Sample for Hall Effect

P-1018751

Zinc Sample for Hall Effect

P-1018752

Holder for Hall Effect

P-1018753

Required to generate magnetic field:

- P-1000988 Coil D with 600 Taps (2x)
- P-1000979 U Core D
- P-1009935 Pair of Pole Shoes and Clamping Brackets D for Hall Effect
- P-1003312 DC-Power Supply 0 – 20 V, 0 – 5 A (230 V, 50/60 Hz)
- or
- P-1003311 DC-Power Supply 0 – 20 V, 0 – 5 A (115 V, 50/60 Hz)

Additionally required:

- P-1002771 DC Power Supply 0 – 16 V, 0 – 16 A
- P-1001016 Microvoltmeter (230 V, 50/60 Hz)
- or
- P-1001015 Microvoltmeter (115 V, 50/60 Hz)
- P-1008537 Teslameter E
- P-1012892 Flexible Magnetic Field Sensor

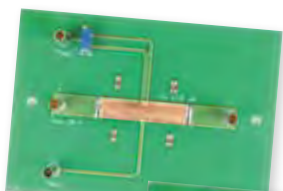

P-1018751



P-1018752



P-1018753



Experiment set-up: Hall effect in metals



UK Adaptors Included



Power Supply for Optical Lamps

Powerful electronic power supply, e.g. for the operation of lamps as used in optics. Short circuit proof, with connection leads and two cascadable 4 mm safety plugs.

Output: 12 V, max. 5 A

Transformer 12 V, 60 VA (230 V, 50/60 Hz)

Dimensions: approx. 100x45x70 mm³

P-1000593

Transformer 12 V, 60 VA (115 V, 50/60 Hz)

Dimensions: approx. 75x45x45 mm³

P-1006780

Transformer 12 V, 25 VA

Simple transformer for student exercises. Short circuit proof, with connection leads and two cascaded 4 mm safety plugs.

Output: 12 V AC, max. 2 A

Dimensions: approx. 110x95x65 mm³

Weight: approx. 0.64 kg

Transformer 12 V, 25 VA (230 V, 50/60 Hz)

P-1000866

Transformer 12 V, 25 VA (115 V, 50/60 Hz)

P-1000865



Plug In Power Supply 24 V, 700 mA

Plug in 24 V power supply for the operation of a Pohl torsion pendulum (P-1002956). With 2 m lead and two stackable 4 mm safety plugs.

Output: 24 V AC, max. 700 mA

Plug In Power Supply 24 V, 700 mA (230 V, 50/60 Hz)

P-1000681

Plug In Power Supply 24 V, 700 mA (115 V, 50/60 Hz)

P-1000680



Plug-In Power Supply, 12 V AC

Plug-in power supply with co-axial power connector.

Art. No.	Voltage	Max. current	Power Connector	Mains voltage
P-1012900	12 V AC	2000 mA	5.5x2.5 mm	230 V, 50/60 Hz
P-1012899	12 V AC	2000 mA	5.5x2.5 mm	115 V, 50/60 Hz
P-1001014	12 V AC	750 mA	5.5x2.1 mm	230 V, 50/60 Hz
P-1009545	12 V AC	500 mA	5.5x2.1 mm	115 V, 50/60 Hz



P-1002772

Voltage Regulating Transformer (230 V, 50/60 Hz)

High performance voltage regulating transformer with high load capacity and continuously adjustable AC output voltage. Two digital rms displays for current strength and output voltage. Thermally protected against overload with an overcurrent circuit breaker. Output electrically isolated from mains input.

- Output: 0 – 260 V AC, max. 3 A
- Overload protection: Thermal
- Display: 3 digit LCD
- Connection: earthed socket outlet
- Power: 780 VA
- Voltage supply: 230 V \pm 10% 50/60 Hz
- Dimensions: approx. 250x235x178 mm³
- Weight: approx. 20 kg

P-1002772

**Robust,
simple
and clearly
laid out**

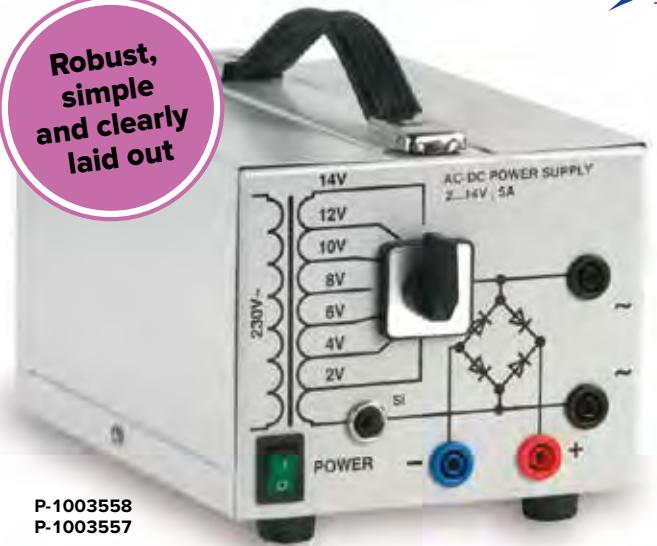

P-1003558
P-1003557

Transformer with Rectifier 2/ 4/ 6/ 8/ 10/ 12/ 14 V, 5 A

Safety isolating transformer with safety cut out contained in metal housing. Output voltage switchable in 7 steps

- AC output: 2/ 4/ 6/ 8/ 10/ 12/ 14 V, max. 5 A
- DC output: 2/ 4/ 6/ 8/ 10/ 12/ 14 V, max. 5 A
- Terminals: 4 mm safety sockets
- Dimensions: approx. 260x140x130 mm³
- Weight: approx. 3.1 kg

Transformer with Rectifier 2/ 4/ 6/ 8/ 10/ 12/ 14 V, 5 A (230 V, 50/60 Hz)

P-1003558

Transformer with Rectifier 2/ 4/ 6/ 8/ 10/ 12/ 14 V, 5 A (115 V, 50/60 Hz)

P-1003557



P-1017579

refer also to page 136

Table-Top Power Supply

Table-top power supply for supply of power to the heat conduction equipment set.

- Mains voltage: 100 – 240 V AC/1 A, 50/60 Hz
- Output voltage: 12 V DC/4 A

P-1017579



P-1003316
P-1003315

Transformer with Rectifier 3/ 6/ 9/ 12 V, 3 A

Extra low voltage power supply with overload protection contained in plastic housing. Output voltage switchable in four stages.

- AC output: 3/ 6/ 9/ 12 V, max. 3 A
- DC output: 3/ 6/ 9/ 12 V, max. 3 A
- Terminals: 4 mm safety sockets
- Dimensions: approx. 210x170x90 mm³
- Weight: approx. 2.6 kg

Transformer with Rectifier 3/ 6/ 9/ 12 V, 3 A (230 V, 50/60 Hz)

P-1003316

Transformer with Rectifier 3/ 6/ 9/ 12 V, 3 A (115 V, 50/60 Hz)

P-1003315



P-1002776
P-1002775

AC/DC Power Supply 0 – 12 V, 3 A

Extra low voltage power supply with continuously adjustable, stabilised and regulated DC output voltage and illuminated, analogue display panel. DC voltage output is short circuit proof and noise voltage proof. Four AC outputs galvanically isolated from the DC voltage outputs are overload protected via semiconductor fuses (multifuses).

DC output: 0 – 12 V, max. 3 A

Stability under full load: ≤ 20 mV

Residual ripple

under full load: ≤ 2 mV

Analogue display:

class 2.5

AC outputs: 3, 6, 9, 12 V, max. 3 A

Terminals: 4 mm safety sockets

Dimensions: approx. 230x115x190 mm³

Weight: approx. 3.5 kg

AC/DC Power Supply 0 – 12 V, 3 A (230 V, 50/60 Hz)

P-1002776

AC/DC Power Supply 0 – 12 V, 3 A (115 V, 50/60 Hz)

P-1002775



P-1001007
P-1001006

AC/DC Power Supply 0 – 12 V, 3 A, stab.

Extra low voltage power supply with continuously adjustable, stabilised DC voltage or stabilised AC voltage. Selection between DC and AC output voltage is performed using a toggle switch.

DC output: 0 – 12 V, max. 3 A, stabilised

AC output: 0 – 12 V, max. 3 A, stabilised

Dimensions: approx. 160x170x65 mm³

Weight: approx. 2.9 kg

AC/DC Power Supply 0 – 12 V, 3 A, stab. (230 V, 50/60 Hz)

P-1001007

AC/DC Power Supply 0 – 12 V, 3 A, stab. (115 V, 50/60 Hz)

P-1001006



P-1002769

AC/DC Power Supply 0 – 30 V, 5 A (230 V, 50/60 Hz)

Continuously adjustable AC/DC power supply unit with digital displays for voltage and current readings, particularly suitable for experiments for students and trainees. The outputs are galvanically isolated. A pushbutton can be used to turn the capacitor filtration of the output direct voltage on and off (smoothing). In the event of an overload, the device is turned off by a thermal overload protection switch.

DC output: 0 – 30 V, max. 5 A

AC output: 0 – 30 V, max. 5 A

Max. output power: 150 VA

Display: 2x 3 digit LED

Digit height: 15 mm

Connections: 4 mm jacks

Voltage supply: 230 V $\pm 10\%$ 50/60 Hz

Dimensions: approx. 280x205x140 mm³

Weight: approx. 8.3 kg

P-1002769



P-1003562
P-1003561

AC/DC Power Supply 0 – 20 V, 0 – 5 A

Power supply with adjustable and stabilised DC voltage and analogue voltage and current display for DC voltage. The DC voltage component features an automatically alternating voltage and current control and is protected against continuous short circuits. The AC voltage can be selected in eight steps, the output is protected by an overcurrent circuit breaker. The AC and DC voltage outputs are DC isolated. A temperature regulated fan protects the unit from overheating.

DC output: 0 – 20 V, 0 – 5 A

AC output: 2, 4, 6, 8, 10, 12, 15, 20 V, max. 5 A

Ripple U: < 10 mV

Dimensions: approx. 235x175x245 mm³

Weight: approx. 8 kg

AC/DC Power Supply 0 – 20 V, 5 A (230 V, 50/60 Hz)

P-1003562

AC/DC Power Supply 0 – 20 V, 5 A (115 V, 50/60 Hz)

P-1003561



P-1008691
P-1008690

AC/DC Power Supply 1/ 2/ 3/...15 V, 10 A

AC and DC power supply adjustable to various levels and housed in metal case. Particularly suitable for experiments by pupils and for lab practicals. Features stabilised DC voltages. Outputs are galvanically isolated and short-circuit-proof.

- DC output: 1/ 2/ 3/ 4/ 5/ 6/ 7/ 8/ 9/ 10/ 11/ 12/ 13/ 14/ 15 V, max. 10 A
- AC output: 1/ 2/ 3/ 4/ 5/ 6/ 7/ 8/ 9/ 10/ 11/ 12/ 13/ 14/ 15 V, max. 10 A
- Max. output power: 150 VA
- Connections: 4 mm jacks
- Dimensions: approx. 170x160x250 mm³
- Weight: approx. 6.3 kg

AC/DC Power Supply 1/ 2/ 3/...15 V, 10 A (230 V, 50/60 Hz)

P-1008691

AC/DC Power Supply 1/ 2/ 3/...15 V, 10 A (115 V, 50/60 Hz)

P-1008690

Usable as a current source



P-1003593
P-1008692

AC/DC Power Supply, 0 – 30 V, 0 – 6 A

Combined power supply with separate AC and DC outputs plus separate displays of output voltage and current. The DC output can be used as a voltage source or current source and can be set to any value within its range. The AC output features current limiting and is electronically protected against overload.

- DC voltage: 0...30 V
- DC current: 0...6 A
- AC voltage: 0...30 V
- AC current: max. 6 A
- Dimensions: 380x140x300 mm³ approx.
- Weight: 12 kg approx.

AC/DC Power Supply 0 – 30 V, 0 – 6 A (230 V, 50/60 Hz)

P-1003593

AC/DC Power Supply 0 – 30 V, 0 – 6 A (115 V, 50/60 Hz)

P-1008692

with current limiting



P-1008535
P-1008534

DC Power Supply 450 V

Power supply with three outputs for the electric supply in experiments with the Electrometer (P-1001025 resp. P-1001024).

- Output 1:
 - Voltage: 0 – 450 V DC
 - Max. current: 10 µA
- Output 2:
 - Voltage: 1.2 – 12 V DC
 - Max. current: 100 mA
- Output 3:
 - Voltage: 0 – 12 V AC
 - Max. current: 10 mA
- Dimensions: approx. 250x100x160 mm³
- Weight: approx. 0.8 kg

DC Power Supply 450 V (230 V, 50/60 Hz)

P-1008535

DC Power Supply 450 V (115 V, 50/60 Hz)

P-1008534



P-1003560

DC Power Supply 1.5 – 15 V, 1.5 A (230 V, 50/60 Hz)

Handy DC power supply contained in a sturdy metal housing. The output voltage is continuously adjustable and is displayed via an analogue measuring instrument. The output is short circuit proof and floating.

- Output voltage: 1.5 – 15 V, max. 1.5 A
- Residual ripple: 10 mV
- Terminals: 4 mm safety sockets
- Voltage supply: 230 V ±10% 50/60 Hz
- Dimensions: approx. 100x80x150 mm³
- Weight: approx. 2 kg

P-1003560



P-1002763
P-1002762

Usable as
a current
source



P-1002771

DC Power Supply

Universal power supply with a digital display for voltage and current. The output voltage and current are continuously adjustable. The device can be used as a constant voltage supply with current limiting or as a constant current supply with voltage limiting. Two or more devices can be operated in parallel or series.

Display: 2x 3 digit LED
Accuracy: 1% + 2 digits for U , 1% + 4 digits for I
Terminals: 4 mm safety sockets
Dimensions: approx. 210x132x255 mm³

	P-1002761 P-1002760	P-1002763 P-1002762
Output voltage	0 – 16 V	0 – 32 V
Output current	0 – 10 A	0 – 2.5 A
Output power	160 W	80 W
Stability under full load	≤10 mV	≤10 mV
Residual ripple	≤4 mV	≤4 mV
Weight	ca. 5.9 kg	ca. 5.3 kg

DC Power Supply 0 – 16 V, 0 – 10 A (230 V, 50/60 Hz)

P-1002761

DC Power Supply 0 – 32 V, 0 – 2.5 A (230 V, 50/60 Hz)

P-1002763

DC Power Supply 0 – 16 V, 0 – 10 A (115 V, 50/60 Hz)

P-1002760

DC Power Supply 0 – 32 V, 0 – 2.5 A (115 V, 50/60 Hz)

P-1002762



P-1003312
P-1003311

Usable as
a current
source



P-1012857
P-1012858

DC Power Supply 0 – 16 V, 0 – 20 A

DC high current power supply with digital display of voltage and current. The voltage and current are continuously adjustable by means of coarse and fine controllers. The device can be used as a constant voltage source with current limiting, or a constant current source with voltage limiting. The selected operating mode is indicated by an LED on the front panel. High reliability even under extremely adverse conditions is ensured by automatic transformer switchover, MOSFET power amplifiers and temperature controlled fan speed with monitoring function. This equipment is also provided with a preset function for protecting against excess current and voltage. The design of the device omits any air vents at the top or bottom and does not require an external heat sink. The output is protected against sustained short circuits. Two or more such units can be operated in series or in parallel.

DC output: 0 – 16 V, 0 – 20 A
Fine adjustment range U : 800 mV
Stability at 0 – 100% load: <12 mV
Residual ripple: <1 mV
Fine-adjustment range I : 2 A
Connections: 4 mm jacks
Mains connection: 115 V/230 V, 50/60 Hz
Dimensions: approx. 240x120x300 mm³
Weight: approx. 10 kg

P-1002771

DC Power Supply 1 – 32 V / 0 – 20 A

High-quality switched-mode power supply in space-saving housing with intelligent control of fan speed to ensure safe and quiet operation. Simple, precise and fast adjustment of voltage and current levels with dual-function rotary knobs for coarse and fine adjustment. Adjustable current limiting in open circuit. Three user-definable stored configurations for voltage and current limiting make it easy to recall frequently used settings. Full remote control of voltage and current plus output which can be turned on and off.

Display: 3-digit, 15 mm, green LED
Output voltage: 1 – 32 V DC
Output current: 0 – 20 A (output with pole terminals on rear)
0 – 5 A (output with 4-mm safety sockets on front)
Max. power output: 640 W
Residual ripple: 5 mV rms
Efficiency: > 87.0 %
Dimensions: approx. 200x90x255 mm³
Weight: 2.6 kg

DC Power Supply, 1 – 32 V / 0 – 20 A (230 V, 50/60 Hz)

P-1012857

DC Power Supply, 1 – 32 V / 0 – 20 A (115 V, 50/60 Hz)

P-1012858

DC Power Supply 0 – 20 V, 0 – 5 A

Universal power supply with digital current and voltage display. Output voltage and output current are continuously adjustable. The device can be used as a constant voltage source with current limiting or as a constant current source with voltage limiting.

DC output: 0 – 20 V, 0 – 5 A
Output power: 100 W
Stability under full load: ≤0.01% + 5 mV, ≤0.2% + 5 mA
Residual ripple: ≤1 mV, 3 mA
Display: 2x 3 digit LED
Terminals: 4 mm safety sockets
Dimensions: approx. 130x150x300 mm³
Weight: approx. 4.7 kg

DC Power Supply 0 – 20 V, 0 – 5 A (230 V, 50/60 Hz)

P-1003312

DC Power Supply 0 – 20 V, 0 – 5 A (115 V, 50/60 Hz)

P-1003311

4
outputs



P-1003310
P-1003309

P-1003308
P-1003307



P-1001012
P-1001011



With ramp generator

DC Power Supply 0 – 500 V

Low voltage power supply with four outputs primarily intended to supply power for electron tubes and Helmholtz coils simultaneously, with four independently adjustable DC voltages and analogue dials for each of them. The DC voltages are stabilised and regulated, floating and galvanically isolated from one another, short circuit proof and secure from external voltages.

- 500 V output: 0 – 500 V DC, max. 50 mA
- 50 V output: 0 – 50 V DC, max. 50 mA
- 8 V output: 0 – 8 V DC, max. 3 A
- 12 V output: 0 – 12 V DC, max. 4 A
- Displays: Analogue, class 2
- Connections: 4 mm safety sockets
- Power consumption: 50 VA
- Dimensions: 85x325x190 mm³ approx.
- Weight: 4 kg approx.

DC Power Supply 0 – 500 V (230 V, 50/60 Hz)

P-1003308

DC Power Supply 0 – 500 V (115 V, 50/60 Hz)

P-1003307

! Ideal for operation of numerous electron tubes (cf. pages 232 ff)

- Regulated high-voltage output not dependent on mains voltage
- High-voltage-proof supply for heater voltage

High Voltage Power Supply 5 kV

Universally applicable, floating, high-voltage source for operation of electron tubes. With built in, high voltage resistant transformer to supply the heater voltage for electron tubes. Continuously adjustable high voltage, safe to touch, with passive current limitation and analogue voltage display.

- High voltage output: 0 – 5000 V DC, max. 2 mA, max. 5 W
- Heater voltage output: 6.3 V AC, max. 3 A, high voltage resistant up to 5 kV
- Overload protection: Primary: fuse
Secondary: current-limiting resistors
- Connections: 4 mm safety sockets
- High-voltage display: Analogue
- Dimensions: 235x130x155 mm³ approx.
- Weight: 3.5 kg approx.

High Voltage Power Supply 5 kV (230 V, 50/60 Hz)

P-1003310

High Voltage Power Supply 5 kV (115 V, 50/60 Hz)

P-1003309

DC Power Supply 0 – 300 V

Low voltage power supply for operating tubes. In addition, a ramp generator is available for experiments on the law of induction and the charging and discharging of capacitors.

- Outputs: 0 – 300 V DC, max. 200 mA/
0 – 50 V DC, max. 10 mA/
4 – 12 V DC, max. 400 mA

- Ramp generator: 2.5 – 50 V/s, linear rising or falling
- Operating voltage: 230/115 V AC, 50 (60) Hz
- Connections: 4 mm safety sockets
- Dimensions: 240x230x170 mm³ approx.
- Weight: 3.7 kg approx.

DC Power Supply 0 – 300 V (230 V, 50/60 Hz)

P-1001012

DC Power Supply 0 – 300 V (115 V, 50/60 Hz)

P-1001011

! Ideal for operation of numerous electron tubes (cf. pages 232 ff)

- Very high-quality and extremely lightweight equipment in modern casing
- 3-digit digital display for high voltage
- Regulated high-voltage output not dependent on mains voltage
- High-voltage-proof supply for heater voltage
- No need to change fuses

High-Voltage Power Supply E 5 kV

Universally applicable, floating high-voltage source for electrostatic experiments and for operating spectral tubes, gas discharge tubes and electron tubes. With built-in transformer resistance to external voltage to provide the heating voltage for electron tubes. Continuously adjustable high-voltage source, which is safe to touch, with passive current limiting and digital voltage display.

- High-voltage output: 0 – 5000 V DC, max. 2 mA, floating
- Heater voltage output: 6.3 V AC, max. 3 A, resistance to voltage up to 5 kV
- Overload protection: Reversible fuse, 3 A
- Connectors: 4-mm safety sockets
- Power consumption: 35 VA
- High-voltage display: 3-digit LED
- Dimensions: 240x220x90 mm³ approx.
- Weight: 2 kg approx.

High-Voltage Power Supply E 5 kV (230 V, 50/60 Hz)

P-1013412

High-Voltage Power Supply E 5 kV (115 V, 50/60 Hz)

P-1017725



P-1013412
P-1017725



P-1009957
P-1009956

Advantages

- Easy and accurate adjustment
- With built-in continuous sweep-mode
- Ideal for recording resonance curves

FG 100 Function Generator

Function generator with power amplifier for use in versatile student and practical experiments covering simple harmonic oscillation, AC electricity and induction. Featuring illuminated, digital display for frequency, signal form, offset and other parameters. The output is short-circuit protected as well as being protected against induced voltages and spark discharges, e.g. for when experiment leads are unintentionally pulled out while coils are connected. In internal sweep mode, one trigger pulse is output per cycle and the voltage output is proportional to the frequency. With retractable feet. Includes power supply.

Signals:

Frequency range: 0.001 Hz to 100 kHz
 Signal forms: Sine, square, triangular
 Offset: 0 to ± 5 V, adjustable in 0.1 V steps

Output:

Output amplitude: 0 to 10 V, continuously adjustable
 Power output: 10 W, permanent
 Output current: 1 A, permanent, 2 A max.

Sweep:

Sweep modes: External, continuous internal, individual internal
 Frequency range: 1 Hz to 100 kHz

Stop/start

frequency ratio: Max. 1000:1, e.g. 2 Hz to 2 kHz max.
 Time range: 0.04 s to 1000 s
 External sweep: Start via trigger pulse or application of 0 to 5 V control voltage

Max. modulation

frequency: 200 Hz
 Internal sweep: Start and stop via Start/Stop button
 One trigger output per cycle plus proportional voltage

General data:

Power supply: Plug-in power supply, 12 V AC, 2 A
 Dimensions: 170x105x40 mm³
 Additional features: Fold-out feet

FG 100 Function Generator (230 V, 50/60 Hz)

P-1009957

FG 100 Function Generator (115 V, 50/60 Hz)

P-1009956



P-1001037
P-1001036

Power Function Generator

Function generator with external sweep capability including power amplifier designed to conduct experiments on simple harmonic oscillation, alternating current and induction. Can be used as a function generator, a stabilised current source or a power amplifier. Equipped with a digital frequency display showing value and unit and an electronic circuit to protect against capacitive and inductive overload.

Frequency display: 3½ digit LED display with 13 mm digit height
 Unit display: mHz, Hz, kHz

Function generator:

Waveform: Sinusoidal, triangular, square-wave
 Frequency range: 10 mHz – 100 kHz, 7 decades
 Output voltage: 0 – 20 V, 10 mA, short-circuit proof
 DC Offset: 0 – ± 10 V
 Internal resistance: 10 m Ω
 Modulation: FM and AM via external generator
 Sweep range: sweep through 7 decades

Power unit:

Frequency range: 0 – 50 kHz
 Input impedance: 1 M Ω || 60 pF
 AF-gain: 10
 Max. output power: 30 W
 Dimensions: approx. 125x170x225 mm³
 Weight: approx. 6.5 kg

Power Function Generator (230 V, 50/60 Hz)

P-1001037

Power Function Generator (115 V, 50/60 Hz)

P-1001036

refer also to pages 100 and 205



P-1009957
P-1009956

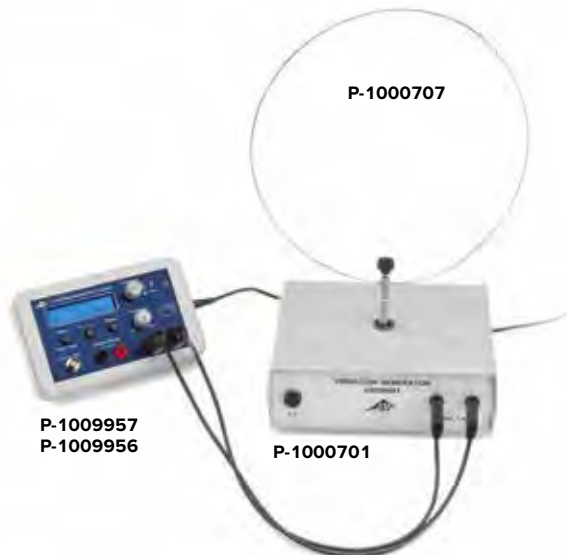

P-1000707

P-1009957
P-1009956

P-1000701

Experiments with the Function Generator SG10

Periodic reversal of the direction of rotation of a DC motor:

- P-1017337 Function generator SG10 (230 V, 50/60 Hz)
- or
- P-1017338 Function generator SG10 (115 V, 50/60 Hz)
- P-1001041 DC motor 12 V
- P-1001046 Barrel Foot
- P-1002849 Pair of safety experiment leads

Periodic changes in the display of a voltmeter:

- P-1017337 Function generator SG10 (230 V, 50/60 Hz)
- or
- P-1017338 Function generator SG10 (115 V, 50/60 Hz)
- P-1013526 Analogue Multimeter ESCOLA 30
- P-1002849 Pair of safety experiment leads



Ideal for
introductory
student
experiments



P-1017337
P-1017338

Function Generator SG 10

Sine-wave generator, which is particularly easy to use, featuring a power amplifier for use in student experiments. Includes 12 V AC plug-in power supply. One red and one green LED indicate the positive and negative half-waves of the output voltage. Their brightness corresponds to the configured amplitude. The way the output signal changes over time can be traced by means of an analog voltmeter with zero-point in the centre or by means of an oscilloscope. The output is protected against short-circuits and against induced voltages as well as spark discharges.

Signal form:	Sine-wave
Frequency range:	0.01 – 10 Hz
Output amplitude:	1 – 10 V _{pp} , continuously adjustable
LED display:	As of 2 V output voltage
Output power:	1.5 W permanent
Output current:	300 mA max.
Distortion factor:	<5%
Connectors:	4-mm safety sockets
Power supply:	12 V AC, 500 mA plug-in power supply
Dimensions:	100x75x35 mm ³ approx.
Weight:	400 g approx. including plug-in supply

Function Generator SG10 (230 V, 50/60 Hz)

P-1017337

Function Generator SG10 (115 V, 50/60 Hz)

P-1017338

Sine Wave Generator

Sine wave generator with power output up to 16 W in a frequency range from 1 Hz to 100 kHz. The apparatus contains a preamplifier, which can be used in isolation (e.g. as a microphone amplifier) or with a power output stage connected downstream as a broadband amplifier (0 up to 100 kHz).

Sine wave generator with power output:

Frequency range: 1 Hz – 100 kHz, in 5 decadic stages, scale with linear division

Frequency deviation: <5 %

Output voltage: 0 – 6 V, adjustable

Max. output current: 10 A, short circuit proof

Max. output power: 16 W constant, 30 W temporary

Input impedance: 100 kΩ

Preamplifier:

Gain factor: 1 – 300, continuously adjustable

Input: AC coupled, with switchable microphone voltage

Max. output voltage: 10 V_{pp}

Max. output current: 15 mA, short circuit proof

Output impedance: 1 kΩ

Power amplifier:

Voltage gain: 8.5

Operating voltage: 12 V AC

Dimensions: approx. 160x160x50 mm³

Weight: approx. 1.1 kg

P-1001038

Additionally required:

P-1000866 Transformer 12 V, 25 VA (230 V, 50/60 Hz)

or

P-1000865 Transformer 12 V, 25 VA (115 V, 50/60 Hz)

P-1001038





P-1008677

Two-Channel Function Generator, 20 MHz

Incorporating DDS (Direct Digital Synthesis) technology, this real, two-channel function generator generates stable, highly precise signals with low distortion. Waveforms can be selected in standard form with variable parameters including frequency, amplitude, offset and phase, or edited freely. Numerous modulation types are implemented. A frequency meter is integrated.

- Channels: 2 independent channels with adjustable phase
- Frequency range: 1 μ Hz...20 MHz (sine)
- Standard signals: Constant, sine, rectangular, ramp, pulse, exponential rise / fall, sync, white noise
- Editable signals: 48 pre-configured forms (100 MSa/s, 14-bit vertical accuracy)
- Modulation: Amplitude (AM), frequency (FM), phase (PM), frequency shift keying (FSK), sweep, burst
- Display: LCD, 256 pixels x 64 pixels, 4 grey stages, graphic and alphanumeric
- Frequency meter: 100 mHz to 200 MHz
- Outputs: Signals, synchronization signal, external modulation signal
- Inputs: External modulation signal, external 10-MHz signal, external trigger signal
- Interface configurations: USB device, USB host
- Supply voltage: 100 – 240 V, 50/60 Hz
- Dimensions: approx. 230x110x290 mm³
- Weight: approx. 2.7 kg

P-1008677

Oscilloscope Probe, 100 MHz

Probe to extend the voltage measurement range of any standard commercial oscilloscope. A changeover switch allows selection of bandwidth. The device includes a channel identification terminal, spring-loaded terminal connection, ground lead, insulating cover tip, measuring tip, special tip for IC measurements, trimmer key and BNC adaptor.

- Bandwidth: DC to 100 MHz (1:10), DC to 6 MHz (1:1)
- Input resistance: 10 M Ω (1:10), 1M Ω (1:1)
- Input capacitance: 16 pF (1:10), 90 pF (1:1)
- Max. measuring voltage: 600 VDC, 600 VAC
- Connection: BNC plug
- Cable length: approx. 1.20 m

P-1002777



P-1002777



P-1002744

Function Generator 0.02 Hz – 2 MHz (230 V, 50/60 Hz)

Multifunctional function generator with four different functions in a single device: function generator, sweep generator, pulse generator and 50 MHz frequency meter.

- Frequency range: 0.02 Hz – 2 MHz in 7 ranges
- Accuracy: \pm 5%
- Waveform: Sine, square, triangle, pulse, saw-tooth, ramp
- Signal outputs:
 - Output voltage: 0 – \pm 5 V_{pp}
 - Output impedance: 50 Ω \pm 5%
 - Attenuator: 0 – 20 dB continuously adjustable and 20 dB fixed
- Sinusoidal: Ripple factor <1% (0.2 Hz – 100 kHz)
- Square-wave: Rise time <120 ns
- Triangular: Linearity error <1% (0.2 Hz – 100 kHz)
- Rise time TTL: <25 ns
- Rise time CMOS: <140 ns (max.)
- Pulse duty factor: 1:1 – 10:1
- Sweep generator:
 - Sweep generator: internal or external, linear
 - Sweep frequencies: 0.02 Hz – 2 MHz (7 ranges)
 - Sweep time: 20 ms – 2 s
- Frequency meter:
 - Frequency range: 200 mHz – 50 MHz
 - Accuracy: 5% of reading \pm 1 Digit
 - Max. input voltage: 250 V_{pp}
 - Input impedance: 890 Ω
 - Display: 6-digit LED
 - Supply voltage: 230 V, 50/60 Hz
 - Dimensions: approx. 280x240x90 mm³
 - Weight: approx. 2 kg

P-1002744

Analogue Oscilloscope, 1x10 MHz (230 V, 50/60 Hz)

Analogue single channel oscilloscope with all the functions and possible display modes of conventional dual beam analogue oscilloscopes. With a bandwidth of 10 MHz, this is a high performance device which is easy to operate, even for inexperienced users.

P-1002745

Additionally recommended:

P-1002777 Oscilloscope Probe 100 MHz

P-1002745



Analogue Oscilloscope, 2x20 MHz (230 V, 50/60 Hz)

Robust, easy-to-operate dual channel oscilloscope with a bandwidth of 20 MHz. Includes 2 adaptors and 2 BNC/4-mm safety plug connector cables.

P-1008695

Additionally recommended:

P-1002777 Oscilloscope Probe 100 MHz

P-1008695



Analogue Oscilloscope, 2x30 MHz

Microprocessor controlled analogue oscilloscope for the display of rapid periodic signals. With SMART AUTOSET for both channels, which reproduces the last configuration used when the device is switched back on.

P-1002727

Additionally recommended:

P-1002777 Oscilloscope Probe 100 MHz

P-1002727



	P--1002745	P--1008695	P--1002727
Vertical deflection			
Operation modes	CH1, XY	CH1, CH2, -CH2, DUAL (ALT/CHOP) ADD, XY	CH1, CH2, -CH2, ALT, CHOP, ADD, XY
Bandwidth	10 MHz	20 MHz	30 MHz
Rise time	≤ 35 ns	≤ 17.5 ns	< 11.7 ns
Deflection coefficient	5 mV/div. – 5 V/div., 10 steps	5 mV/div. – 20 V/div., 12 steps	5 mV/div. – 20 V/div., 12 steps
Accuracy.	±3%	±3%	±3%
Input impedance	1 MΩ ±3% // 25 pF ±5 pF	1 MΩ // 25 pF	1 MΩ // 25 pF
Horizontal deflection			
Time coefficient	100 ns/div. – 100 ms/div., 19 steps	200 ns/div. – 500 ms/div., 20 steps	50 ns/div. – 200 ms/div., 21 steps
Accuracy	±3%	±5%	±3%
Enhancement	---	up to 10 ns/div.	up to 10 ns/div.
Accuracy	---	±10%	±5%
Triggering			
Operation mode	Auto, Normal, TV	Auto, Normal, TV-V, TV-H	Auto, Normal, TV
Trigger source	Y INPUT, LINE, EXT	CH1, CH2, ALT, LINE, EXT	CH1, CH2, ALT, LINE, EXT
Trigger coupling	DC	AC	DC, AC, LFR, HFR, TVV, TVH
Data			
Screen size	48x60 mm ²	80x100 mm ²	80x100 mm ²
Supply voltage	230 V, 50/60 Hz	230 V, 50/60 Hz	94 – 264 V, 48 – 440 Hz
Dimensions	approx. 278x215x85 mm ³	approx. 435x330x160 mm ³	approx. 435x330x163 mm ³
Weight	approx. 3 kg	approx. 5.5 kg	approx. 5.5 kg



P-1008676

Digital Oscilloscope 4x 70 MHz

Capable of simultaneously displaying four independent channels in colour, this digital oscilloscope offers the following functions: Storage and recall of measured signals, automatic measurement of up to 22 parameters, mathematical operations including fast Fourier transformation, delayed sampling, digital filtering. Including four probes, software and USB cable.

Inputs:

- Coupling: DC, AC, GND
- Impedance: $1\text{ M}\Omega \pm 2\%$
- Capacitance: $18\text{ pF} \pm 3\text{ pF}$
- Probe attenuation factors: 0.001x – 1000x
- Maximum input voltage: $100\text{ V}_{\text{rms}}, 1000\text{ V}_{\text{pp}}$ (in CAT II)
- Mathematical operations: FFT, +, -, *

Vertical deflection:

- Deflection coefficient: 2 mV/div. – 10 V/div., 12 stages
- Offset range: $2 \pm 40\text{ V}$ ($245\text{ mV/div.} \sim 10\text{ V/div.}$)
 $\pm 2\text{ V}$ ($2\text{ mV/div.} \sim 245\text{ V/div.}$)
 $\pm 4\%$ ($2\text{ mV/div.} - 5\text{ mV/div.}$)
 $\pm 3\%$ ($10\text{ mV/div.} - 10\text{ V/div.}$)
- Accuracy: $\pm 4\%$ ($2\text{ mV/div.} - 5\text{ mV/div.}$)
 $\pm 3\%$ ($10\text{ mV/div.} - 10\text{ V/div.}$)
- A/D converter: 8-bit resolution
- Bandwidth: 70 MHz
- Rise time: <5 ns

Horizontal deflection:

Time coefficient: 5 ns/div. – 50 s/div., 31 stages

Trigger:

Trigger sensitivity: 0.1 div. – 1.0 div., adjustable
Trigger threshold: $\pm 6\text{ div.}$ (internal),
 $\pm 1.2\text{ V}$ (EXT),
 $\pm 6\text{ V}$ (EXT/5)

Trigger hold-off: 100 ns – 1.5 s

Operating mode: Edge, pulse width, video, pattern and alternate trigger

Cursor measurements:

- Manual: Voltage difference, time difference, reciprocal time difference
- Track: Voltage values for Y-axis
Time values for X-axis
- Automatic: On-line

Automatic measurement:

Measurement variables: $V_{\text{pp}}, V_{\text{amp}}, V_{\text{max}}, V_{\text{min}}, V_{\text{top}}, V_{\text{base}}, V_{\text{avg}}, V_{\text{rms}}$
Overshoot, Preshoot, Freq, Period, Rise Time, Fall Time, +Width, -Width, +Duty, -Duty, Delay A→B+, Delay A→B-, Phase A→B+, Phase A→B-

General data:

- Display: TFT-LCD, 5.7 inches, 320 pixels x 240 pixels, 64 k colours
- Memory: 16 k
- Interface configurations: USB device, dual USB host
- Supply voltage: 100 – 240 V, 50/60 Hz
- Dimensions: approx. $325 \times 160 \times 135\text{ mm}^3$
- Weight: approx. 3 kg

P-1008676



P-1017264

USB Oscilloscope 2x50 MHz

Meant for connection to a PC with USB ports, this two-channel USB oscilloscope comes with a USB cable as well as Windows software. On being connected to a PC, the digital storage oscilloscope not only offers a wide spectrum of features but also the added advantage of being able to save measured data and process them further, for example, for purposes ranging as far as FFT analysis. The monitor's surface is modelled after that of a conventional oscilloscope. Operation is facilitated by an auto-set function for automatic adaptation to measuring signals and numerous trigger functions.

- Channels: Two
- Operating modes: CH1, CH2, X/Y
- Sampling rate: 150 MS/s
- Input coupling: DC, AC, GND
- Input impedance: $1\text{ M}\Omega \parallel 50\text{ pF}$
- Input voltage: 0 – 35 V
- Deflection coefficient: 10 mV/div. – 5 V/div.
- Accuracy: $\pm 3\%$
- A/D converter: 8-bit resolution
- Bandwidth: 50 MHz
- Time coefficient: 4 ns/div. – 1 h/div.
- Roll mode: 1 s/div. – 1 h/div.
- Trigger: Auto/Normal/Single/Ext.
- Calibrator: 1 kHz/ 2 Vpp
- Memory depth: 10 – 64 kpts
- Interface: USB 2.0
- Voltage supply: Via two USB ports
- Dimensions: $205 \times 38 \times 125\text{ mm}^3$
- Weight: 430 g
- Windows: 98SE/ ME/ 2000/ XP/ Vista™/ Windows® 7
- Analysis options: LabVIEW® compatible, data transfer to spreadsheet programs

P-1017264

Advantages

- Easily portable, low-weight, built-in fold-out handle
- High performance and a multitude of data acquisition and analysis functions
- Three ways of recording data in two separate modes: real-time or time-equivalent
- Simple MATHS functions: $+/-/x/\div$ and FFT functions in real time with simultaneous display of curves
- Built-in test overlay with Pass/Fail display for rapid testing of signals
- Optimised signal analysis
- Fast saving of measurement curves to USB Stick via USB HOST interface
- USB and serial ports for connection to a computer
- EASYSCOPE software makes it possible to operate the equipment from a PC, allowing function tests and saving of curve data and screenshots to computer.



P-1018581

Digital-Oszilloskope

Modern and easy-to-use digital oscilloscopes in space-saving case with large screen and colour display. Includes two voltage probes, USB A/B connection lead, CD with EASYSCOPE PC software.

Digital Oscilloscope, 2x 25 MHz

P-1018581

Digital Oscilloscope, 2x 40 MHz

P-1018582

Digital Oscilloscope, 2x 100 MHz

P-1018583

	P-1018581	P-1018582 / P-1018583
Vertical deflection		
Channels	Two	Two
Band width	25 MHz	40 MHz / 100 MHz
Rise time	<14 ns	<8 ns / 3,5 ns
Deflection coefficient	2 mV/div. – 10 V/div., 12 levels	2 mV/div. – 10 V/div., 12 levels
Precision	±3%	±3%
Input impedance	1 MΩ // 18 pF	1 MΩ // 18 pF
Horizontal deflection		
Time coefficient	25 ns/div. – 50 s/div.	2,5 ns/div. – 50 s/div.
Scan or roll modes	100 ms/div. – 50 s/div.	100 ms/div. – 50 s/div.
Trigger		
Trigger source	CH1, CH2, Ext, Ext/5, mains	CH1, CH2, Ext, Ext/5, mains
Trigger mode	Automatic, triggered, single-shot – X/Y	Automatic, triggered, single-shot – X/Y
Roll mode	100 ms/div. – 50 s/div.	100 ms/div. – 50 s/div.
Trigger resolution	Edge, pulse width (20 ns – 10 s), video (PAL, Secam, NTSC), gradient, alternating, HOLD OFF 10 ns – 1.5 s	Edge, pulse width (20 ns – 10 s), video (PAL, Secam, NTSC), gradient, alternating, HOLD OFF 10 ns – 1.5 s
Trigger coupling	AC, DC, HFR (HF suppression), LFR (LF suppression)	AC, DC, HFR (HF suppression), LFR (LF suppression)
Digital memory		
Max. sampling rate	Single-shot 250 MS/s (2 channels), 500 MS/s (1 channel), repeating signals 10 GS/s	Single-shot 500 MS/s (2 channels), 1 GS/s (1 channel), repeating signals 50 GS/s
Vertical resolution	8 Bit	8 Bit
Memory depth	Internal memory up to a maximum of 32K points, "unlimited" memory if using USB sticks	Internal memory up to a maximum of 2 M points (long MEM), "unlimited" memory if using USB sticks
User memory	2 MB for data storage: curves, text, configurations, Maths function, print files, image data etc.	2 MB for data storage: curves, text, configurations, Maths function, print files, image data etc.
System requirements	up to Windows 8, 64 Bit	up to Windows 8, 64 Bit
General data		
Display	7" TFT LCD colour screen, resolution 480x234 pixels	7" TFT LCD colour screen, resolution 480x234 pixels
Mains voltage	100 – 240 V, 50/60 Hz	100 – 240 V, 50/60 Hz
Dimensions	320x150x135 mm approx.	320x150x135 mm approx.
Weight	approx. 2.4 kg	approx. 2.4 kg



Art. No.	Designation	Meas. ranges	Scale division	Internal resistance
P-1002786	Ammeter, DC	50 mA, 500 mA, 5,0 A	1 mA, 10 mA, 0.1 A	10 Ω
P-1002787	Voltmeter, DC	3.0 V, 15 V, 300 V	0.1 V, 1 V, 10 V	1 kΩ/V
P-1002788	Ammeter, AC	1.00 A, 5.0 A	0.02 A, 0.1 A	Rectifier
P-1002789	Voltmeter, AC	15.0 V, 150 V	0.5 V, 5 V	Rectifier
P-1002790	Galvanometer, DC	±35 μA	1 μA	1000 Ω

Measuring Instruments for Student Use

Sturdy pointer instruments for measuring current or voltage. In shock proof desktop housings. Built especially for student and practical lab experiments. With moving coil instruments, mirror scale and 4 mm safety sockets.

Accuracy: class 2.0

Dimensions: approx. 90x106x103 mm³

Analogue Multimeter AM50

Hand held multimeter for measuring voltage and current for a wide range of applications in student and practical experiments. A heavy duty device with excellent overload protection, zero point of scale centre or left and automatic battery cut off after approx. 45 minutes.

Measuring ranges:

Direct voltage: 100 mV–300 V, 8 steps

Alternating voltage: 3 V–300 V, 5 steps

Direct current: 0.1 mA–3 A, 6 steps

Alternating current: 0.1 mA–3 A, 6 steps

Internal resistance: 10 MΩ

Scale zero-point: Centre/left

Accuracy: class 2 (DC) / class 3 (AC)

Supply voltage: 1x 9 V battery

Dimensions: approx. 98x138x35 mm³

Weight: approx. 0.3 kg

P-1003073

Analogue Multimeter AM51

Low price hand held multimeter for measuring current, voltage and resistance. For universal use in student experiments and practicals.

Measuring ranges:

Direct voltage: 100 mV–600 V, 7 steps

Alternating voltage: 10 V–600 V, 5 steps

Direct current: 50 μA–1 A, 5 steps

Alternating current: 3 mA–3 A, 4 steps

Resistance: Ωx1/ 10/ 100

Internal resistance: 20 kΩ/V (DC) / 6.67 kΩ/V (AC)

Scale zero-point: left

Accuracy: class 2.5

Supply voltage: 1x 1.5 V battery

Dimensions: approx. 98x138x35 mm³

Weight: approx. 0.25 kg

P-1003074

Zero Point Galvanometer CA 403

Reasonably priced, sturdy and easy to use analogue measuring instrument with moving coil instrument and rectifier, particularly well suited for student and practical experiments, may be used as a DC microammeter and DC millivoltmeter. This device has only one control knob, includes safety sockets and quick break fuses, is electrically protected and double insulated.

Measuring ranges: 100 mV DC, 30 μA DC, 3 mA DC

Internal resistance: 3333 Ω, 460 Ω, 500 Ω

Accuracy: ±1.5%

Zero point: centre

Mirrored scale: yes

Connection: 4 mm security sockets

Fuse: 0.315 A HBC 380 V

50 kA

Dimensions: approx.

165x105x50 mm³

Weight: approx. 450 g

P-1002726



P-1003073



P-1003074



P-1002726

Advantages

- Unmistakeable measurement readings
- Only an inexpensive 1.5-V battery element is needed for operation
- Full functionality guaranteed even when the battery is no longer fully charged
- Lithium batteries with higher open-circuit voltage can also be used
- Battery protected by automatic cut-off after approximately 50 mins.
- Distinct difference between 0 V display and the equipment being switched off due to inherently different position of needle



P-1013526

No need to change fuses



P-1013527

CAT III, 600 V

The ideal meter for student experiments: Analogue Multimeters ESCOLA

Clear moving-coil instrument in shock-resistant plastic casing with two mirrored linear scales and clearly distinguishable measuring ranges. Includes battery test function and display of charge status as well as electronic calibration of zero point to the centre of the scale for all DC current and voltage ranges. Use of a measurement amplifier ensures the measured values are linear even for AC voltages of up to 40 kHz. Only an inexpensive 1.5 V battery element is needed for operation. Nevertheless the meter will work for several years after any change of battery with normal usage, since the current discharge when in operation is no more than 2.5 mA maximum.

Scale length:	80 mm
Operating voltage:	1 – 3.5 V DC
Battery type:	Mignon, AA, R6
Accuracy:	Class 2 (DC), class 3 (AC)
Dimensions:	approx. 100x150x50 mm ³
Weight:	approx. 300 g

Analogue Multimeter ESCOLA 30

Permanently short-circuit-proof student measuring instrument for measuring voltage and current in the safety extra-low voltage range. The electronic overload protection is achieved without the use of an equipment fuse, therefore obviating any need to change fuses or order spares. The protective system nevertheless operates without any auxiliary energy and is guaranteed even when the battery is flat or no battery is present.

Direct and alternating voltage:	0.3 – 30 V, 5 ranges each
Direct and alternating current:	1 – 3000 mA, 5 ranges each
Instrument category:	CAT I, 30 V

P-1013526

Note:

Electrical safety of measuring instruments for current and voltage are assessed according to measurement categories stipulated in IEC 611010-1:

CAT I or unstipulated: Approved for measurements in circuits which are not directly connected to the low voltage mains grid (e.g. batteries).

CAT II: Approved for measurements in circuits which are directly connected, by a mains lead and plug for instance, to the low voltage mains grid (e.g. household or office appliance and lab equipment).

CAT III: Approved for measurements in circuits which are part of a building's wiring installation (e.g. stationary consumers, distribution terminals, appliances connected directly to the distribution box).

CAT IV: Approved for measurements in circuits which are directly connected to the source of the low voltage mains (e.g. electricity meters, main service feed, primary excess voltage protection).

N.B.: the closer measurement is to be made to the low-voltage mains installation, the higher the measuring category needs to be.

Analogue Multimeter ESCOLA 100

Meter for classroom and practical experiments to measure voltage and current up to 600 V or 10 A respectively. Also features audible continuity testing. Includes a fuse to guarantee safety up to CAT III. The separate terminal sockets for current and voltage permit connection of the instrument that allows for current as well as voltage to be measured without having to reconnect the measuring leads. When switching from one measuring range to another, the circuit is never broken. All current measuring ranges are overload-proof for long-term current of up to 10 A. The generous protection of all current measuring ranges by means of additional semiconductor protection prevents inadvertent blowing of the fuse in many cases.

Direct and alternating voltage:	0.1 – 600 V, 9 ranges each
Direct and alternating current:	0.1 mA – 3000 mA, 11 ranges each
Internal resistance:	1 MΩ
Long term maximum voltage:	600 V
Instrument category:	CAT III, 600 V (DIN EN 61010-1:2010, 61010-2-033:2012)

P-1013527

Tested safety



P-1002783

With automatic cut-off



P-1002781



P-1002785

Digital Mini Multimeter

Very reasonably priced mini multimeter in pocket format for measuring voltage, DC current, resistance and temperature and also including diode and continuity tests. Overload protection for mA ranges, 10 amp range is unprotected. Includes measuring leads, type K thermocouple and battery.

- DC voltage: 200 mV–250 V, 5 ranges, $\pm 0.8\%$ ± 2 digits
- AC voltage: 200/ 250 V, 2 ranges, $\pm 1.2\%$ ± 10 digits
- DC current: 200 μ A–10 A, 5 ranges, $\pm 1.0\%$ ± 2 digits
- Resistance: 200 Ω –2000 k Ω , 5 ranges, $\pm 0.8\%$ ± 2 digits
- Temperature: 0–1000°C, $\pm 2.0\%$ ± 3 digits
- Display: 3½ digit LCD, 12 mm, max: 1999
- Operating voltage: 9 V battery
- Safety classification: CAT II 250 V (IEC-1010-1)
- Dimensions: approx. 70x140x30 mm³
- Weight: approx. 210 g

P-1002783

Digital Multimeter P1035

Compact 3½ digit multimeter for measuring voltage, current and resistance and also including diode and continuity tests. Complete with pouch, leads and battery.

- DC voltage: 200 mV–600 V, 5 ranges, $\pm 0.5\%$ ± 2 digits
- AC voltage: 200/ 600 V, 2 ranges, $\pm 1.2\%$ ± 10 digits
- DC current: 2000 μ A–10 A, 4 ranges, $\pm 1\%$ ± 2 digits
- Resistance: 200 Ω –2000 k Ω , 5 ranges, $\pm 0.8\%$ ± 2 digits
- Display: 3½ digit LCD, 27 mm, max: 1999
- Operating voltage: 9 V battery
- Safety classification: CAT III 600 V (IEC-1010-1)
- Dimensions: approx. 70x150x48 mm³
- Weight: approx. 260 g

P-1002781

Digital Multimeter P3340

Digital multimeter for universal use in measuring voltage, current, resistance, frequency, capacitance, temperature and also including diode and continuity tests. Includes a measurement value hold function, analogue bar graphs, automatic polarity reversing, overload and overvoltage protection as well as an acoustic overload indicator, automatic switch off. Device comes in a shock-proof holster with fold-out stand. Including testing leads, type K temperature sensor and batteries.

- DC voltage: 400 mV–1000 V, 5 ranges, $\pm 0.5\%$ ± 2 digits
- AC voltage: 4–700 V, 4 ranges, $\pm 1.2\%$ ± 3 digits
- DC current: 400 μ A–10 A, 6 ranges, $\pm 1\%$ ± 3 digits
- AC current: 400 μ A–10 A, 6 ranges, $\pm 1.5\%$ ± 5 digits
- Resistance: 400 Ω –40 M Ω , 6 ranges, $\pm 1\%$ ± 2 digits
- Capacity: 40 nF–100 μ F, 5 ranges, $\pm 3\%$ ± 5 digits
- Temperature: -20–760°C, $\pm 3\%$ ± 3 digits
- Display: 3¾ digit LCD, 39 mm, max: 3999
- Operating voltage: 9 V battery
- Safety classification: CAT II 1000 V (IEC-1010-1)
- Dimensions: approx. 92x195x38 mm³
- Weight: approx. 200 g

P-1002785

True
RMS

USB



P-1002784



P-1006809



P-1008631

Digital Multimeter P3320

Digital multimeter for universal use in measuring voltage, current, resistance, frequency, capacitance and temperature. With real time rms measurement feature and backlighting. 3⁵/₆ digit LCD display with function symbols and analogue bar graphics. Automatic and manual range selection. With non-contact voltage detector. Includes measuring leads, type K thermocouple, shock resistant pouch and battery.

DC voltage:	600 mV–1000 V, 5 ranges, $\pm 1.2\%$ ± 2 digits
AC voltage:	6 V–1000 V, 4 ranges, $\pm 1.5\%$ ± 10 digits
DC current:	6 A–10 A, 2 ranges, $\pm 2.5\%$ ± 5 digits
AC current:	6 A–10 A, 2 ranges, $\pm 3\%$ ± 5 digits
Resistance:	600 Ω –60 M Ω , 6 ranges, $\pm 1\%$ ± 2 digits
Capacity:	40 nF–4000 μ F, 6 ranges, $\pm 5\%$ ± 5 digits
Frequency:	10 Hz–10 MHz, 7 ranges, $\pm 1.2\%$ ± 3 digits
Temperature:	-20–760°C, $\pm 3\%$
Display:	3 ⁵ / ₆ digit LCD, 19 mm, max: 3999
Operating voltage:	9 V battery
Safety classification:	CAT III 600 V / CAT II 1000 V (IEC-1010-1)
Dimensions:	approx. 70x150x48 mm ³
Weight:	approx. 260 g

P-1002784

Digital Multimeter E

Compact 3¹/₂-digit multimeter for measuring voltage, current and resistance as well as for diode and hFE gain testing. Overload protection in μ A/mA range but no protection for 20-A range. Folding digital display. Includes measuring leads and battery.

DC voltage:	200 mV–1000 V, 5 ranges, $\pm 0.5\%$ ± 1 digit
AC voltage:	200 mV–750 V, 5 ranges, $\pm 0.8\%$ ± 3 digits
DC current:	20 μ A–20 A, 7 ranges, $\pm 0.8\%$ ± 1 digit
AC current:	20 μ A–20 A, 7 ranges, $\pm 1.0\%$ ± 3 digits
Resistance:	200 Ω –20 M Ω , 6 ranges, $\pm 0.8\%$ ± 1 digit
Display:	3 ¹ / ₂ display LCD, 24 mm, max. 1999
Operating voltage:	9-V-battery 6F22
Dimensions:	approx. 85x185x35 mm ³
Weight:	approx. 230 g

P-1006809

Digital Multimeter P3415

This innovative digital multimeter uses an opto-coupled USB cable to connect directly to a computer to allow you to record up to three measurements per second. A wide range of functionalities such as autoranging, relative measurements, and Min/Max/Hold also make this a highly versatile stand-alone tool. Measuring modes include DCV, ACV, DCA, ACA, resistance, diode, continuity, frequency, capacitance and temperature. The unit is supplied with a carrying case, USB cable, Software for Windows 2000/XP/Vista/7, type-K thermocouple, test leads, test clips, battery and operation manual.

DC voltage:	600 mV–1000 V, 5 ranges
AC voltage:	600 mV–700 V, 5 ranges
DC current:	600 μ A–10 A, 6 ranges
AC current:	600 μ A–10 A, 6 ranges
Resistance:	600 Ω –60 M Ω , 6 ranges
Frequency:	100 Hz–1 MHz, 5 ranges
Capacity:	60 nF–300 μ F, 5 ranges
Temperature:	-55°C–1000°C, 2 ranges
Display:	3 ⁵ / ₆ digit LCD, 18 mm
Operating voltage:	9 V battery (included)
Safety classification:	CAT III 1000 V / CAT IV 600 V (IEC-1010-1)
Dimensions:	90x190x40 mm ³ approx.
Weight:	500 g approx.

P-1008631



P-1012817



P-1012816



P-1012865

True
RMS

DMM Digital Multimeter

Digital multimeter for conducting measurements in situations where a high degree of safety needs to be assured. Automatic blocking of sockets (ABS), which are not used for specific functions. Back-lit liquid crystal display with digital read-out and analogue bar chart scale. Economy mode with automatic shut-off after 10 minutes without the measured reading changing. Excess voltage and overload warning, automatic or manual range selection, data storage and maximum and minimum functions. Supplied with measurement leads, 9-V block battery, spare fuse, English instructions, test report and impact-resistant protective case with stand legs and carrying strap.

Measured variables and ranges:

DC voltage:	30.00 mV (10 μ V) – 1000 V (1 V), 6 ranges $\pm 0.25\% \pm 1$ digit
AC voltage:	3.000 V (1 mV) – 1000 V (1 V), 4 ranges $\pm 0.75\% \pm 1$ digit
Direct current:	300.0 μ A (100 nA) – 10.00 A (10 mA), 6 ranges $\pm 1.00\% \pm 2$ digits
Alternating current:	3.000 mA (1 μ A) – 10.00 A (10 mA), 4 ranges $\pm 1.50\% \pm 2$ digits
Resistance:	30.00 Ω (10 m Ω) – 30.00 M Ω (10 k Ω), 7 ranges
Capacitance:	30.00 nF (10 pF) – 30.00 μ F (10 nF), 4 ranges
Frequency:	300.0 Hz (0.1 Hz) – 100.0 kHz (100 Hz), 4 ranges

Other variables:

Duty cycle:	2.0% – 98.0%
Temperature*:	-200.0 $^{\circ}$ C – +850.0 $^{\circ}$ C (Pt 100) -100.0 $^{\circ}$ C – +850.0 $^{\circ}$ C (Pt 1000)
Continuity test:	Yes
Diode test:	2 V

* Sensors available on request

Other data:

Safety category:	CAT III 1000 V (IEC 61010-1:2001) CAT IV 600 V (IEC 61010-1:2001)
Dimensions:	200x80x30 mm ³
Weight:	700 g approx.

DMM50 Digital Multimeter

Digital multimeter without true RMS (TRMS) measurement capability.

P-1012817

DMM60 Digital Multimeter

Digital multimeter with true RMS (TRMS) measurement capability for distorted input signals.

P-1012816

DMM 1000 Iso-Multimeter

Digital multimeter with integrated insulation resistance measuring capability for voltages from 50 V to 1000 V and additional measuring functions for testing AC and DC voltage and current, resistance, capacitance, frequency and temperature plus diode testing. Automatic blocking of sockets (ABS), which are not used for specific functions. Automatic shut-off, excess voltage and overload warning, true RMS (TRMS) measurement capability for distorted input signals. Back-lit liquid crystal display with digital read-out and analogue bar chart scale. Supplied with English instructions and impact-resistant protective case with stand legs.

Safety category:	CAT II 1000V CAT III 600 V
------------------	-------------------------------

P-1012865

Sound Level Meter P5055

Universally deployable digital meter used to determine the sound level of any number of acoustic sources across a wide sound range. Device is housed in a robust plastic casing with integrated calibration signal and large LCD display for easy reading of measured values. Includes range selection switch and maximum hold function. There are two evaluation levels (A and C) available for the frequency. The measurement in the A-range is oriented on the human ear and is particularly well suited for measurements out in the open, while the C-range is designed for measurements of motor noise. The device's response time can be adjusted between fast and slow. The slow mode brings about attenuation of the measurement i.e. the measured value displayed corresponds to the average sound level. Fast mode is used to measure brief noise sequences and to determine the maximum noise level. Furthermore, the device also offers the option of connecting an external measuring instrument (e.g. for compiling and printing out measurement sequences) via an analogue output (phone jack). On the underside of the sound level meter there is a drill hole for attaching to a stand. Supplied in a foam lined portable bag.

Measurement range:	35 – 130 dB
Resolution:	0.1 dB
Accuracy:	±3.5 dB at 94 dB (1kHz)
Display:	3½-digit LCD display
Digit height:	17 mm
Microphone:	Electret capacitor microphone
Power supply:	9 V block-type battery
Dimensions:	251x64x40 mm ³ approx.
Weight:	250 g approx.

P-1002778

Digital Energy Meter

Digital meter for measuring consumption of electrical energy by appliances connected to the mains and for determining bills given a rate for kilowatts per hour. It is also possible to demonstrate stand-by operation for larger appliances. If the connected appliance consumes more than 3600 W a warning signal is emitted. Supplied with an internal battery for memory back-up.

Values displayed:	Energy, costs incurred, power, voltage, current, time, day of the week
Input voltage:	230 V, 50/60 Hz
Maximum permitted load:	3680 W/16 A
Minimum load for display:	1 W/0.005 A
Energy:	0.00 – 9999.99 kWh
Current:	0 – 16 A
Active power:	1 – 3680 W
Accuracy:	±1%
Safety classification:	Cat II 300 V (IEC-1010-1)
Operating voltage:	internal battery for memory back-up
Dimensions:	128x64x78 mm ³
Weight:	170 g

P-1002802

Digital Luxmeter

Reasonably priced, easy to use pocket luxmeter for testing and measurement of light conditions. C.I.E. standard spectrum. Including light sensor, pouch and battery.

Measuring ranges:	200 – 50000 lux, 4 ranges, ±5%
Operating voltage:	Battery
Dimensions:	approx. 65x115x25 mm ³
Weight:	approx. 160 g

P-1002779

Noise Level Meter P8005

Digital noise level meter with circuit for suppressing background noise for measuring all types of sound levels in the environment, including noise levels in schools, offices, factories, traffic noise, household noise or for noise-reduction projects. Allows for manual or automatic selection of levels and measurements of minimum and maximum levels. Thanks to its built in USB port, the supplied 9 V mains adaptor and stand, it is also suitable for permanent or long term measurement. Includes case, USB cable, Windows software, stand, 9 V mains adaptor, 9 V battery and instruction manual.

Digital display:	4 digit LCD
Height of digits:	20 mm
Multi-functions display:	58x44 mm ²

Digital display of measurement, measuring time, bar graphs plus overs and unders

Background lighting:	blue
Applicable standards:	IEC-61672-1 type 2, ANSI S1.4 type 2
Frequency range:	31.5 Hz – 8 kHz
Dynamic range:	50 dB
Level ranges:	30 – 80 dB (low) 50 – 100 dB (medium) 80 – 130 dB (high) 30 – 130 dB (automatic)

Resolution:	0.1 dB
Precision:	±1.4 dB
Response times:	125 ms (fast), 1s (slow)
Microphone:	½-inch, with electret capacitor
Display update:	Twice a second
Analogue output:	AC/DC
Operating voltage:	9 V battery or 9 V mains adaptor
Dimensions:	90x280x50 mm ³ approx.
Weight:	350 g approx.

P-1002780





P-1001033
P-1001032

Digital Counter

Digital counter/timer for measuring duration of motion, transition times, periods, pendulum periods and frequencies, as well as for counting events or Geiger tube pulses. Includes a speaker that can be turned on and off, power supplies for direct connection to light barriers (P-1000563) or for powering a Geiger-Müller counter (P-1001035). For event counting, a fixed counting period can be programmed in a range from 1 s to 99999 s. Counter events (start, stop) can either be triggered by a signal to the input sockets or manually via switches. Includes plug in power supply.

Time measurement:	0.1 ms – 99999 s
Resolution:	0.1 ms / 1 ms / 0.1 s
Frequency measurement:	1 – 100 kHz, where voltage > 1.5 V _{pp}
Resolution:	1 mHz (1 – 100 Hz), 1 Hz (1 – 100 kHz)
Counting periods:	1/10/60 s or manually triggered
Input A:	miniDIN 8 socket, 4 mm safety sockets
Input B:	miniDIN 8 socket, 4 mm safety sockets
Input voltage A:	0.5 V – 15 V AC
Input voltage B:	1 V – 15 V AC
Active edge:	Rising/falling
Counter tube input:	BNC socket
Power supply:	550 V / 1 MΩ
Display:	5 digit LED display
Operating voltage:	9 – 12 V DC via plug in power supply
Dimensions:	250x100x160 mm ³ approx.
Weight:	0.8 kg approx.

Digital Counter (230 V, 50/60 Hz)

P-1001033

Digital Counter (115 V, 50/60 Hz)

P-1001032



P-1001033
P-1001032



P-1001035

P-1001046



P-1000563

P-1001046



P-1001033
P-1001032

P-1001033
P-1001032



P-1000738

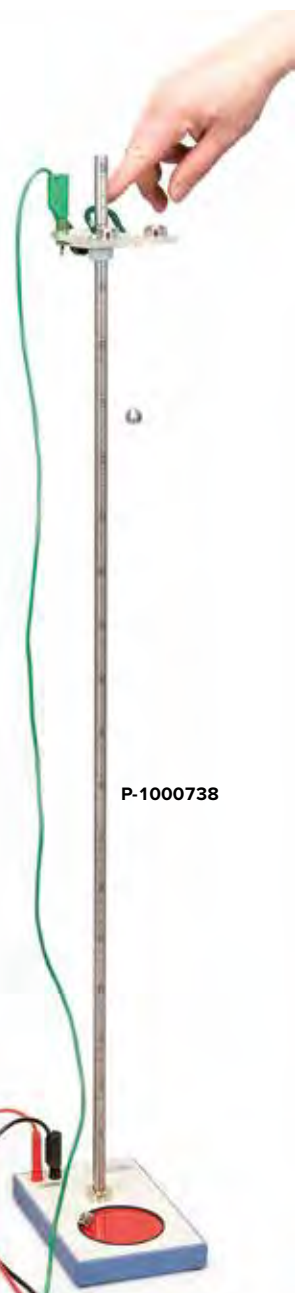



P-1003123
P-1003122



P-1012832
P-1012833

Digital Counter with Interface

Microprocessor controlled digital counter for measuring duration of motion, transition times, periods, pendulum periods and frequencies, as well as for counting events or Geiger tube pulses. Keyboard operated. With adjustable trigger edge, speaker that can be turned on and off, power supply for direct connection to light barriers (P-1000563) and adjustable low voltage output for supplying a Geiger-Müller tube (P-1001035). With RS 232 interface and supplied cable plus software for graphic depiction of measured data and export to spreadsheet programs.

Frequency (Input A):

Measuring range: 0.01 Hz – 100 kHz
Resolution: 10 mHz – 10 Hz
Type of measurement: Repeated measurement/
single measurement

Period of oscillation (Input A):

Measuring range: 1 ms – 100 s
Resolution: 0.01 – 10 ms
Type of measurement: Repeated measurement/
single measurement

Pulse counting (Input A)/rate

measurement (counter tube input):

Measuring range: 0 – 9999 pulses
Resolution: 1 pulse
Type of measurement: Continuous measurement
Single measurement for counting periods of 1 s, 6 s, 10 s, 60 s, repeated measurement for a period of 10 s

Time for motion between A and B:

Measuring range: 0.01 ms – 100 s
Resolution: 0.01 ms
Start: START/STOP button, pulse at A.
Stop: START/STOP button, pulse at B.

Transition times via A and B:

Measuring range: 0.01 ms – 100 s
Resolution: 0.01 ms
Type of measurement: Simultaneous measurement
at both inputs

Transition time and period of motion:

Measuring range: 0.01 ms – 100 s
Resolution: 0.01 ms
Type of measurement: Time for motion from A to B, time for transition at A, time for transition at B

Input A: BNC socket, miniDIN 8 socket, two 4 mm safety sockets
Input B: BNC socket, miniDIN 8 socket, two 4 mm safety sockets

Tube input: BNC socket (on reverse)
Power supply: 300 – 625 V DC, continuously adjustable
Measurement display: 7 segment LED, 4 digit
Height of digits: 20 mm
Function display: LCD with illumination, 2x 16 digit
Computer connection: RS 232
Power consumption: 20 VA approx.
Dimensions: 95x245x185 mm³ approx.
Weight: 5 kg approx.

Digital Counter with Interface (230 V, 50/60 Hz)

P-1003123

Digital Counter with Interface (115 V, 50/60 Hz)

P-1003122

Millisecond Counter

Inexpensive, compact counter for measuring milliseconds, e.g. in conjunction with the free-fall apparatus (P-1000738). Each count is started and stopped by a signal at the input sockets. The device is automatically reset to zero each time it is restarted. Includes plug-in power supply.

Time measurement: 1 ms – 9999 s
Supply voltage: 5 V DC
Connectors: 4-mm safety sockets
Dimensions: 105x75x35 mm approx.
Weight: 400 g approx.

Millisecond Counter (230 V, 50/60 Hz)

P-1012832

Millisecond Counter (115 V, 50/60 Hz)

P-1012833

Digital Stroboscope

Portable microprocessor-controlled device with quartz-controlled time base for observation of periodic movements, as well as for frequency and rotation speed measurement. Xenon flash tube built into a robust plastic casing with handle and photo thread for mounting on a stand, continuous frequency adjustment in two ranges through coarse and fine setting using control knobs, 4-digit digital display permits readings of the desired flash sequence per minute.

Meas. ranges: 100 min⁻¹ – 1000 min⁻¹ (approx. 1.5 Hz – 18 Hz)
1000 min⁻¹ – 10000 min⁻¹ (approx. 18 Hz – 165 Hz)
Accuracy: ± (0.05% + 1 digit)
Display: 4-digit LED
Resolution: 0.1 min⁻¹ (< 1000 min⁻¹)
1 min⁻¹ (1000 min⁻¹ – 9999 min⁻¹)
10 min⁻¹ (10000 min⁻¹)
Flash duration: 60 µs – 100 µs
Flash energy: 4 Ws
Flash angle: 80°
Dimensions: 210x210x120 mm³ approx.
Weight: 1 kg approx.

Digital Stroboscope (230 V, 50/60 Hz)

P-1003331

Digital Stroboscope (115 V, 50/60 Hz)

P-1003330



P-1003331
P-1003330

Spare Bulb, Stroboscope (not shown)

Spare bulb for the Digital Stroboscope (P-1003331/ P-1003330).

P-1003332

Teslameter, 200 mT

This economical digital teslameter will allow students to incorporate quantitative measurements into their magnetism experiments. The unit includes a Hall sensor probe for measuring axial and tangential magnetic fields up to 200 mT. The probe also serves as a ruler as it includes a metric scale. There are two measuring ranges, 0 – ±20 mT and 0 – ±200 mT. The teslameter can be calibrated by the user. In addition to having a digital display, the unit outputs a voltage proportional to the magnetic field which can be measured with a data logger, XY-recorder or analogue multimeter.

Measurement ranges: 0 – ±20 mT, 0 – ±200 mT

Resolution: 0.01 mT, 0.1 mT

Digital Display: 3½ digit LCD

Height of digits: 13 mm

Input: BNC socket

Output: 4 mm safety sockets

Dimensions of unit: 205x230x85 mm³

Dimensions of probe: 360x15x25 mm³



P-1003314
P-1003313

Teslameter, 200 mT (230 V, 50/60 Hz)

P-1003314

Teslameter, 200 mT (115 V, 50/60 Hz)

P-1003313

Teslameter E

Hand-held meter for measuring magnetic flux density B or magnetic field strength H in conjunction with an axial-tangential field sensor (P-1001040) or a flexible magnetic field sensor (P-1012892). The measurements are shown on a digital display and also converted into equivalent voltage outputs, which can be accessed from the analogue output connection.

LCD display: 3½-digit, 10 mm high

Power supply: Rechargeable 9-V block battery providing about 20 hours of operation

Sensor connection: DIN socket

Offset compensation: ±0.150 mT

Measuring modes:

DC-B Flux B of uniform fields

AC-B Flux B of alternating fields (1 Hz – 10 kHz)

AC-H Field strength H of alternating fields (1 Hz – 10 kHz)

Measuring ranges:

Flux B: ±2.000/±20.00/±200.0/±2000 mT

Field strength H: ±2.000/±20.00/±200.0/±2000 A/m

Analogue output:

Connector: 4-mm socket

Range: 0 – ±2 V

P-1008537

Additionally required:

P-1001040 Magnetic Field Sensor, Axial/Tangential

or

P-1012892 Flexible Magnetic Field Sensor

Flexible Magnetic Field Sensor

Flexible magnetic field sensor with built-in Hall sensor for measuring tangential magnetic fields in connection with the E-model teslameter (P-1008537).

Sensitivity: 1 mV/mT

Length of probe

(without handle): 75 mm

Thickness of probe: 0.6 mm

Hall sensor: Monocrystalline InAs

Sensor surface: 1 mm²

Connection: DIN plug

P-1012892

Magnetic Field Sensor, Axial/Tangential

Magnetic field sensor with two built-in Hall sensor probes for measuring axial and tangential magnetic fields in conjunction with the teslameter (P-1008537). A slider switch provides for switching between axial and tangential measuring modes.

Sensitivity: 1 mV/mT

Length of probe

(without handle): approx. 125 mm

Thickness of probe: 4 mm

Hall sensors: Monocrystalline InAs

Sensor surface: 1 mm²

Connection: DIN plug

P-1001040



P-1008537

P-1001040

P-1012892

P-1001028

Measuring Amplifier S

Measuring amplifier for measuring small voltages and current in conjunction with an ordinary voltmeter in the course of student experiments. Measuring range with reference to 1 V output voltage:

Voltage (AC/DC): 1 mV – 1 V
 Current (AC/DC): 100 nA – 100 μ A
 Frequency range: 0 – 20 kHz ($v = 1$)
 0 – 500 Hz ($v = 1000$)

Input impedance: 10 k Ω
 Input U: BNC socket
 Input I: BNC socket
 Max input voltage: 10 V
 Output: 4 mm safety sockets
 Max output voltage: 10 V
 Limiting frequency: 100 Hz
 Gain factor: 106
 Accuracy: 2 %
 Operating voltage: 12 V AC
 Dimensions: approx. 175x85x65 mm³
 Weight: approx. 250g

P-1001028

Additionally required:

P-1000866 Transformer 12 V, 25 VA (230 V, 50/60 Hz)

or

P-1000865 Transformer 12 V, 25 VA (115 V, 50/60 Hz)

P-1003073 Analogue Multimeter AM50

Microvoltmeter

Measuring instrument and amplifier for measuring very small DC and AC voltages, e.g. thermo-voltages, inductive voltages and photo-electric voltages. With LED display. The measuring input includes a filter that can be switched in for smoothing the signal or for setting an upper frequency limit. The signal is input via a BNC socket or 4 mm safety sockets. An additional DIN socket is provided for the connection of Hall sensors, the axial/tangential magnetic field sensor (P-1001040).

Inputs: 4 mm safety sockets, BNC socket, DIN socket
 Outputs: 4 mm safety sockets
 Measuring ranges: 199.9 μ V – 199.9 mV AC /DC, 4 ranges each
 Gain factors: 10 – 10000, 4 decades
 AC frequency range: 10 Hz – 1 kHz
 Input resistance: 100 k Ω (DC), 900 k Ω (AC)
 Upper frequency limit: 1 Hz – 1 kHz, 4 decades
 Precision: 5 %
 Sampling rate: 3 measurements/s
 Output signal: 0 – \pm 2 V, max. 1 mA
 Dimensions: approx. 235x250x180 mm³
 Weight: approx. 3.3 kg

Microvoltmeter (230 V, 50/60 Hz)

P-1001016

Microvoltmeter (115 V, 50/60 Hz)

P-1001015

Additionally recommended:

P-1001040 Magnetic Field Sensor, Axial/Tangential

P-1001022
P-1001021

Measuring Amplifier

Measuring amplifier for recording very small voltage, current and charge. For display purposes, any DC meter capable of measuring in the range up to 10 V can be used with no additional configuration. Including offset correction and polarity switch. Additional outputs are provided so that the -15 V and +15 V operating voltage can be tapped for use in external circuitry, e.g. bridge circuits.

Input: BNC sockets
 Measuring range with reference to 1 V output voltage:
 Voltage: 0.1 mV – 100 V, 7 ranges
 Current: 10 pA – 10 μ A, 7 ranges
 Charge: 10 pAs – 100 nAs, 5 ranges
 Input resistance: 10 Ω (voltage), compensated 0 Ω (charge, current)

Overvoltage protection: up to 300 V
 Precision: typically 3 %
 Signal output: 0 – 10 V, configurable zero point, polarity switch

Fixed voltage output: \pm 15 V, max. 50 mA
 Dimensions: approx. 235x230x180 mm³
 Weight: approx. 2.8 kg

Measuring Amplifier (230 V, 50/60 Hz)

P-1001022

Measuring Amplifier (115 V, 50/60 Hz)

P-1001021

Additionally required:

P-1003073 Analogue Multimeter AM50

P-1001016
P-1001015



P-1003419

Mechanical Balance 610

- Solid, all-metal construction
 - Notched positions for sliding weights on three sliding beams
 - Captive sliding weights
 - Magnetic damping
 - Zero point adjustment
 - Extensible scale range
- Scale range: 0 – 610.0 g (2610.0 g with additional weights)
 Readability: 0.1 g
 Sliding weight: 0.1 – 10 g (front), 10 g – 100 g (rear),
 100 – 500 g (centre)
 Plate diameter: 150 mm

P-1003419

Additional Weights for Mechanical Balance (not shown)
 Additional weights to extend the scale range of the mechanical balance 610 (P-1003419).
 Weights: 1x 0.5 kg, 2x 1 kg

P-1014616

Mechanical Balance 311

- Solid, all-metal construction
 - Notched positions for sliding weights on four sliding beams
 - Captive sliding weights
 - Magnetic damping
 - Zero point adjustment
- Scale range: 0 – 311.00 g
 Readability: 0.01 g
 Sliding weight ranges: 0.01 – 1 g (1st beam), 1 – 10 g (2nd beam),
 10 – 100 g (3rd beam), 100 – 200 g (4th beam)
 Pan diameter: 100 mm

P-1003421



P-1003421

Advantages

- Top quality
- Precision
- High resolution
- Easy to read



P-1018347

AES 200 Analytical Scales

- Precision analytical scales with automatic adjustment mechanism and high resolution. Tough metal casing with complete glass windscreen, large graphic display and RS232 and USB port. The scales offer practically every function needed in laboratories:
- Counting items
 - Percentage weights
 - Switching between different units
 - Capacity display for weight range
 - GLP/ISO protocols
 - Programmable 4-digit ID number
 - CAL adjustment program for setting accuracy
 - Pipette calibration program
 - Dosing mode
 - Alibi memory and internal memory
- Max. measuring range: 220 g
 Precision: 0.1 mg
 Reproducibility: 0.2 mg
 Linearity: ±0.2 mg
 Time to settle: 4 s approx.
 Item counting
 Minimum weight: 0.5 mg
 References: 10, 20, 50, freely selectable
 Weight display: LCD, 17 mm
 Weighing platform: 85 mm diam.
 Power supply: 13.8 V DC power supply, mains voltage
 110 – 230 V, 50/60 Hz
 Dimensions: 206x335x335 mm³
 Weight: 5.4 kg

P-1018347

Advantages

- Flexible power (AC adaptor or batteries)
- Easy to clean (sealed front panel)
- Easy to view (high contrast LC-display)
- Integral shipping lock
- Manual disabling of menu
- Weigh below hook



P-1003429



P-1009772,
P-1003428

Electronic Scales Scout Pro

Precision scales with removable stainless steel platform. Multi-function with percentage weighing, totalisation, display hold, and parts counting. Includes calibrating weight.

Electronic Scales Scout Pro 200 g

P-1009772

Electronic Scales Scout Pro 400 g

P-1003428

Electronic Scales Scout Pro 600 g

P-1003429



P-1003433,
P-1003434

	P-1009772	P-1003428	P-1003429
Weight range:	0 – 200.00 g	0 – 400.00 g	0 – 600.0 g
Accuracy:	0.01 g	0.01 g	0.1 g
Display:	LCD, 6 digits, 15 mm		
Weight ranges:	g, N, oz, %, unit counter	g, N, oz, %, unit counter	g, kg, N, oz, lb, %, unit counter
Calibration:	Automatic using external weight		
Scale pan:	120 mm Ø	120 mm Ø	165x140 mm ²
Dimensions:	approx. 192x54x210 mm ³		
Weight:	approx. 700 g	approx. 700 g	approx. 800 g

Electronic Scales

Universal scales in robust plastic casing, with easy-clean foil keyboard. Menu functions, easy selection using two buttons. High-resolution, easy-to-read LCD display, overload and underload display, battery or mains operation optional. Automatic shutdown after five minutes in battery operation. Batteries included.

	P-1003433	P-1003434
Scale range:	0 – 200.0 g	0 – 5000 g
Accuracy:	0.1 g	1 g
Weight units:	g, lb:oz	g, lb:oz
Counter-balancing range:	subtractive, entire weight range	subtractive, entire weight range
Power supply:	3 AA alkaline batteries	3 AA alkaline batteries
Dimensions:	approx. 193x135x39 mm ³	approx. 193x135x39 mm ³
Weight:	ca. 470 g	ca. 470 g

Accessories:

USB Interface

For connecting Scout Pro to a printer or PC.

P-1003431



P-1003431

P-1002807
P-1002806



Magnetic Stirrer with Heater

Magnetic stirrer with stainless steel hotplate and secure safety circuit. Variable heating temperature and smooth starting stirrer motor. Housing resistant to chemicals.
 Quantity stirred, max. (H₂O): 10 l
 Speed: 100 – 2000 rpm
 Heater power: 400 W
 Heating temperature range: Room temperature to 320° C
 Work plate: 125 mm diam.
 Dimensions: 168x105x220 mm³ approx.
 Weight: 2.4 kg approx.

Magnetic Stirrer with Heater (230 V, 50/60 Hz)

P-1002807

Magnetic Stirrer with Heater (115 V, 50/60 Hz)

P-1002806



P-1011739

12L Magnetic Stirrer (230 V, 50/60 Hz)

Electronically regulated magnetic stirrer in stainless steel casing with an aluminium hot plate. Accommodates stand rods (12 mm diam.) and has a 12 V DC output to supply power to accessories. Includes stirring rods.
 Maximum speed: 1500 rpm
 Hot plate: 135 mm diam.
 Maximum temperature: 450°C
 Power consumption: 400 W
 Dimensions: 165x220x105 mm³
 Weight: 2 kg

P-1011739

P-1002808



Magnetic Stirrer

Ultra flat magnetic stirrer with non wearing drive featuring no moving parts. With feature for changing direction of stirring automatically every 30 seconds for improved homogenisation. Work plate and housing resistant to chemicals, non slip and secure base. Including plug in power supply and stirring rods.
 Quantity stirred, max. (H₂O): 0.8 l
 Speed: 15 – 1500 rpm
 Work plate: 100 mm diam.
 Power supply: power supply unit 100 V– 240 V, 50/60 Hz
 Dimensions: 117x12x180 mm³ approx.
 Weight: 0.3 kg approx.

P-1002808

Electrical Burners

Burners for experiments which would have formerly needed to be undertaken using a Bunsen burner. Designed to be both thermally and electrically safe. Heating via a column of hot air with a patented air management system. Featuring operation and temperature displays.

- Controlled via energy regulator with bimetallic strips
- Protected against overheating
- No overheating of housing during long periods of use
- Boils liquids without causing them to spit
- Perfectly sealed against spilt liquids

Liquid reservoir: Up to 140 mm in diameter
 Dimensions: 170x130x195 mm³
 Weight: 3.8 kg



LAB2 Electrical Burner (230 V, 50 Hz)

Operating temperature: 20 – 650°C
 Temperature of heating element: max. 900°C
 Electrical power consumption: 500 W
 Fuse: F-type, 5A, 250 V

P-1010252

LAB3 Electrical Burner (230 V, 50 Hz)

Operating temperature: 20 – 750°C
 Temperature of heating element: max. 1000°C
 Electrical power consumption: 900 W
 Fuse: F-type, 6.3A, 250 V

P-1010253



Set of 60 Ecoflam Pellets

Pellets for environmentally friendly generation of an open flame on the grid of the LAB2 and LAB3 electrical burners.

P-1010255

Plate for Metal Filings

Plate for adding to LAB2 and LAB3 electrical burners in order to burn metal filings in an open flame. Complete with central hole for one ECOFLAM pellet.

P-1010256



P-1010255

Holder for Glassware

Complete accessories for holding test tubes or round-bottom flasks onto the grid of the LAB2 and LAB3 electrical burners. The holder remains sufficiently cool while the glassware is being heated to be safely touched with fingers.

Tube diameter: 12 mm or 35 mm approx.

P-1010254

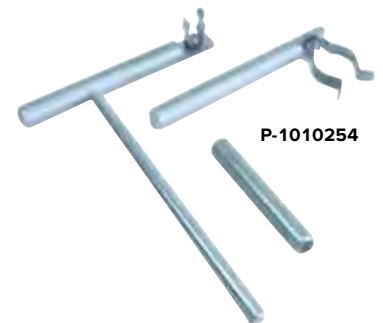

P-1010254

Wick (not shown)

Spare wick for the spirit lamp (P-1003565).

Length: approx. 100 mm

P-1001048

Immersion Heater – 300 W

Immersion heater with protection against overheating (VDE-compliant). Important: operates solely on a mains voltage of 230 V.

P-1003566

Spirit Lamp

Made of metal, with a knurled screw for feeding the wick and cap for extinguishing the flame.

Contents: 60 ml

Dimensions: 55mm x 65 mm diam.

Weight: 50 g approx.

P-1003565



P-1003565



P-1003566

HD Video Flex®

Robust, ultra high resolution desktop digital colour camera for direct connection to a PC or notebook via a USB interface. Thanks to the ball and socket bearing, video head that can pivot and swivel via its flexible gooseneck, the camera can be easily and accurately connected, e.g. to microscopes and telescopes, or directed towards visual material, running processes or items of scientific or technical interest so that they can be viewed on a monitor. The heavy, triangular base ensures the necessary stability. Audio recordings are possible via a microphone equipped computer. An external power supply is not necessary as the camera is powered via the USB connection. Includes microscope adaptor, Applied Vision™ software and carrying case. Compatible with interactive whiteboards. The Applied Vision™ software for picture recording, reproduction and processing is characterised by its user friendliness and features e.g.

- Full screen, real time video
- Still frame recording
- Recording of films in AVI format
- Time-lapse recording
- Internet streaming
- Can be used in local network
- Zoom function
- Image processing
- Brightness, contrast control and positive/negative image display
- Drawing tools
- Organiser/memo function
- Printout of real time images
- Memory function (jpeg, bmp, tiff)
- Choice of background
- Creation of image collages
- Comparison of two adjacent images
- Measurement of the distance between 2 points or the area of a circle
- Exporting data to an Excel spreadsheet or MS Word
- Compatible with Windows, Mac and Linux
- Free software updates
- Unlimited local licences

P-1017789

	P-1017789	P-1003436	P-1012834	P-1012835
Photosensitivity	8 lux	20 lux	20 lux	2 integrated white LEDs
Image digitisation	digital CMOS	digital CMOS	¼" CMOS	digital CMOS
Output signal	digital / USB 2.0	digital / USB 2.0	digital / USB 2.0	digital / USB 2.0
Resolution	HD 1080P	1280x960 SXGA	1280x1024	2048x1536
Live video	up to 30 images per second	up to 30 images per second	up to 30 images per second	up to 30 images per second
TV system	–	–	–	–
Microphone	–	–	–	yes
Lens	8 mm HD	6 mm glass	glass f = 2.8 and 1.729 mm	F2.8 coated
Focal distance	6 mm to infinity	8 mm to infinity		100 mm to infinity
Focus	manual	manual	auto	auto
Microscope adaptor	34.5 mm built-in and 28 mm	34.5 mm built-in and 28 mm	–	28 mm
Power supply	via USB	via USB	via USB	via USB
Cable	USB connecting cable, approx. 170 cm	USB connecting cable, approx. 150 cm	USB connecting cable, approx. 170 cm	USB connecting cable, approx. 180 cm
Dimensions	approx. 180x180x720 mm ³	approx. 180x180x640 mm ³	approx. 180x180x640 mm ³	approx. 200x200x630 mm ³
Weight	approx. 4.55 kg	approx. 1.7 kg	approx. 1.65 kg	approx. 2.04 kg

FlexCam® 2

This modern document camera with high definition (HD) resolution can do the job of multiple presentation devices, e.g. overhead projectors, opaque projectors or slide projectors. Documents, pictures, objects etc. can be laid directly onto the flat base under the camera. The two bright white LEDs integrated into the head of the camera provide excellent illumination of the field of view. A built-in microphone allows sound recordings to be made. Includes microscope adaptor and Applied Vision™ software.

P-1012835

Vision Viewer™

Lighter version of the HD Video Flex® (P-1017789) with similar optical properties (without HD resolution) and for the same applications. The difference is that the video head is directly attached to the gooseneck arm (with no universal joint). Compatible with interactive whiteboards. Includes a microscope adaptor and Applied Vision™ software.

P-1003436

Auto Focus Vision Viewer™

High-resolution, easy-to-use, desk-top colour video camera with a host of uses. Particularly suitable for presenting printed text, images and other objects or even dynamic processes. Includes auto-focus camera lens and wide field of vision (43x36 cm), flexible gooseneck support and integrated USB cable. Compatible with interactive whiteboards. Includes Applied Vision™ software.

P-1012834



P-1012835



P-1003436



P-1012834



P-1005402

Monocular Course Microscope Model 100 (230 V, 50/60 Hz)

The monocular course microscope Model 100 is distinguished by its robust construction and ease of operation. It is equipped with three achromatic objectives as used in common practice and has a simple object stage with two clips for holding slides. It can be supplemented by means of a variety of spare parts and accessories.

P-1005402



P-1012404

Binocular Polarisation Microscope

High-quality mechanics and optics along with ease of operation are the stand-out features of the binocular polarisation microscope. Its compact and ergonomic design makes it easier to work with it. The main application for polarisation microscopes is in mineralogy, where they are used for investigating optically anisotropic objects, e.g. crystals or minerals (intrinsic birefringence) or isotropic materials being acted upon by mechanical forces (stress-induced birefringence).

P-1012404

	P-1005402	P-1012404
Stand	All-metal stand, arm firmly connected with base, pinion knobs attached on both sides of the stand for coarse and fine focusing	Robust, all metal stand with arm permanently connected to the base. Focussing by means of separate knobs for coarse and fine adjustment located on either side of the stand and operated by rack and pinion drive with ball bearings and retaining lever, adjustable stopper for protecting the object slides and objective.
Tube	Monocular inclined 45°, head rotation 360°	Binocular head, 30° viewing angle, 360° rotatable head, viewing distance adjustable between 54 and 75 mm, ±5 dioptic compensation for both eyepieces
Polarisation equipment	–	Polariser with scale and analyser, which can be inserted into the tube.
Eyepieces	Wide field eyepiece WF 10x 18 mm with pointer and eyepiece lock	Pair of wide field eyepieces WF 10x 18
Objectives	Revolving nosepiece with 3 achromatic objectives 4x / 0.10, 10x / 0.25, 40x / 0.65	Inverted objective revolver with 3 achromatic objectives 4x / 0.10, 10x / 0.25, 40x / 0.65
Enlargement	40x, 100x, 400x	40x, 100x, 400x
Object stage	110x120 mm ² with 2 specimen clips	Circular object stage 120 mm in diameter, which can be rotated 360°, scale with Vernier and 2 specimen clips
Illumination	20 W tungsten lamp integrated in base, power supply 230 V, 50/60 Hz	Adjustable 6 V, 20 W halogen lamp incorporated into the base, universal 85 to 265 V, 50/60 Hz power supply
Condenser	Bright-field condenser N.A. 0.65, iris diaphragm, filter holder and blue filter	Abbe condenser N.A. 1.25 with iris diaphragm, focussed via rack and pinion drive
Dimensions	approx. 175x135x370 mm ³	approx. 240x190x425 mm ³
Weight	approx. 2.9 kg	approx. 6 kg
Supplied	Complete with dust cover	Complete with dust cover

Whiteboards

Metal board with enamelled surface for demonstration experiments using magnetic components, e.g., for mechanics or optics. Scratch- and acid resistant steel board that can be written on using water soluble pens. Wall mounted.



P-1002591/P-1002592

Art. No.	Designation	Dimensions
P-1002591	Whiteboard	600x900 mm ²
P-1002592	Whiteboard	900x1200 mm ²



P-1002593

Set of Drawing Instruments for Whiteboard

Consisting of a flat profile ruler with decimetre scale divisions, a triangular set square for geometry, circle instrument with centimetre scale, and a pointing baton. With storage case.

Flat profile ruler: Marked at decimetre intervals, polystyrene, 1000 mm

Set square triangle: Acrylic, 600 mm

Circle instrument: centimetre scale, 520 mm

Pointing baton: Fibreglass, 1050 mm

P-1002593

Set of 3 Thermocouples

Set consisting of three different thermocouples for demonstrating the Seebeck effect and measuring thermo-electric voltage as a function of the difference in temperature from a specific reference point. In each case, to create a temperature difference, the contact point of the thermocouple is immersed in a water bath.

Length of leads: 2 m

Operating

temperature: -75°C to 250°C

Connection: 4-mm safety plugs

Sensitivity: 40 $\mu\text{V}/\text{K}$ (NiCrSi-NiSi)

43 $\mu\text{V}/\text{K}$ (NiCr-NiAl)

54 $\mu\text{V}/\text{K}$ (Fe-CuNi)

Contents: 1 Thermocouple type N, NiCrSi-NiSi

1 Thermocouple type K, NiCr-NiAl

1 Thermocouple type J, Fe-CuNi

P-1017904



P-1018439

Double-Pole Double Throw Switch

Double-pole double throw (DPDT) change-over switch in a robust casing with high dielectric strength. Connection is made via 4-mm safety sockets.

Dimensions: 112 x 62 x 45 mm approx.

Weight: 95 g approx.

P-1018439

Cord for experiments

Plaited hemp string on a bobbin. For a variety of uses, e.g. setting up block and tackle using pulleys P-1003216 to P-1003223 or making a pendulum with bobs P-1003230.

Length: 100 m

Diameter: 1 mm

Maximum tension: 50 N

P-1001055

Cord, 100 m

100 m length of hemp string, black, rolled onto bobbin.

P-1007112

Set of Hook Weights and Thread

Set of propulsion weights and thread for acceleration of sliders on air-cushion track. Consisting of 3 S-shaped hooks, 1 g, 5 S-shaped hooks, 2 g, and 1 roll of sewing thread.

P-1019180

Fishing Line, 10 m

Multi-filament braided nylon cord for use in experiments with trolley track.

Length: 10 m

Diameter: 0.14 mm

P-4009036

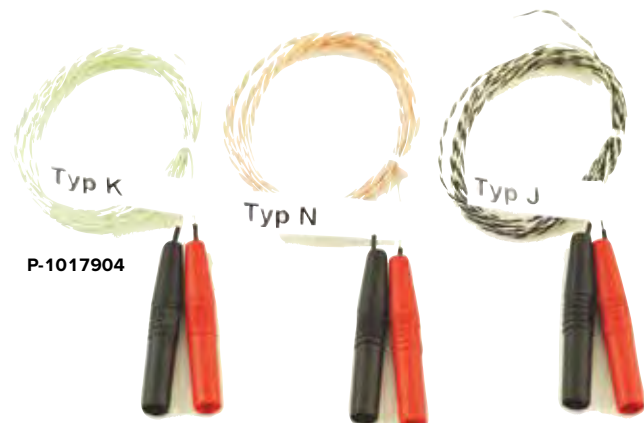

P-1017904

P-1002941



P-1002942
P-1002943



Laboratory Jacks

Height adjustable table with continuously variable extension mechanism for raising experiment equipment. May be fixed in place via wing nuts.

Art. No.	Designation	Maximum load	Tabletop	Height of table	Weight
P-1002943	Laboratory Jack I	30 kg	320x220 mm ²	65 – 250 mm	2.6 kg
P-1002941	Laboratory Jack II	40 kg	200x200 mm ²	70 – 260 mm	2.3 kg
P-1002942	Laboratory Jack III	50 kg	160x130 mm ²	60 – 250 mm	1.2 kg



P-1018874

Stand with H-Shaped Base

Provides a firm base for large and extensive structures, with six clamping positions for stand rods up to 12 mm diameter.
Max. stand area: 300x280 mm²
Weight: 1.7 kg approx.

P-1018874.....



P-1001044

Stand Base, A-Shaped

Adjustable duplex tripod base, extremely stable, for holding two rods of 4 up to 15 mm diameter. Made of grey cast iron.

Art. No.	Leg length	Weight
P-1001044	200 mm	1.5 kg
P-1001043	280 mm	3.7 kg



P-1002835

Tripod Stand

Adjustable duplex tripod base, extremely stable, for holding two rods of up to 16 mm diameter. Distance between rods 135 mm.

Art. No.	Leg length	Weight
P-1002835	150 mm	1450 g
P-1002836	185 mm	1850 g



P-1002834

Barrel Foot, 1 kg

Heavy base for holding rods of up to 13 mm diameter. Made of powder-coated cast iron.

P-1002834.....



P-1001046



P-1001045

Barrel Foot

Heavy base to accommodate stand rods up to 12 mm in diameter and rectangular plates of up to 10 mm or 12 mm thickness. Made of painted cast iron.

Art. No.	Weight	Height	Diameter
P-1001045	0.9 kg	56 mm	64 mm
P-1001046	0.5 kg	47 mm	54 mm

Multiclamp

Universal clamp for attachment of rods up to 13 mm diameter and for holding plates, rulers, etc. of up to 13 mm thickness in a multitude of alignments. Nickel-plated steel screws.

P-1002830



P-1002830

Bosshead

Bosshead for connecting rods of up to 16 mm diameter. Powder-coated zinc die-casting, 110 g. Nickel-plated steel screws.

P-1002827



P-1002827

Cross-Bosshead

Cross-bosshead for connecting rods of up to 20 mm diameter. Powder-coated zinc die-casting, 130 g. Nickel-plated steel screws.

P-1002831



P-1002831

Clamp with Hook

Clamp with hook for attaching rods of up to 16 mm diameter. Powder-coated zinc die-casting, 93 g. Nickel-plated steel screws.

P-1002828



P-1002828

Clamp with Jaw Clamp

Stand clamp with jaw clamp for attaching rods up to 16 mm diameter. Powder-coated zinc die-casting, 190 g. Clamp with cork lining. Clamping width: 20 – 40 mm

P-1002829



P-1002829

Universal Jaw Clamp

Clamp with cork lining. Unpainted zinc die-casting, 180 g. Clamping width: 0 – 80 mm

P-1002833



P-1002833

Adjustable Double Clamp

Double clamp with two grippers which can be rotated by 360° with respect to one another for connecting rods of up to 16 mm in diameter. Powder coated zinc die casting, 180 g. Nickel-plated steel screws.

P-1017870



P-1017870

Table Clamp

Table clamp for vertically attaching rods of up to 13 mm to tabletops. Powder-coated aluminum alloy, 350 g. Clamping width: 0 – 60 mm

P-1002832



P-1002832



P-1002937

P-1002934

SW Stand Equipment Set

Stand equipment for easy, understandable and stable assemblies, e.g. for investigating mechanical oscillations and waves using the sensors from the SW sensors set (P-1012850 or P-1012851). Including SW base plate as non-tilting base to accommodate the stand rods, two double clamps and SW tie bar. The SW tie bar serves as multi-function holder for fitting between stand rods on the base plate in order to build set-ups featuring the dynamic force sensors from the SW sensors set

Base plate: 345x240x16 mm³ approx.
Stand rods: 400 mm x 10 mm diam. approx.

Contents:

- 1 SW Base plate
- 2 Stand rods with internal and external thread
- 2 Stand rods with external thread
- 2 SW Double clamps
- 1 SW Tie bar

P-1012849

Additionally recommended:

- P-1012848 Steel Rod 280 mm
- P-1012847 Steel Rod 400 mm



P-1012848
P-1012847

Stainless Steel Rods

Art. No.	Length	Diameter
P-1002932	100 mm	12 mm
P-1002933	250 mm	12 mm
P-1002934	470 mm	12 mm
P-1002935	750 mm	12 mm
P-1002936	1000 mm	12 mm
P-1002937	1500 mm	12 mm
P-1012848	280 mm	10 mm
P-1012847	400 mm	10 mm



P-1012849

P-1002710

Drilled Rod

Plastic rod with six lateral bore holes and one axial bore hole for the attachment of components with 4 mm plugs.

Length: 250 mm
Diameter: 12 mm
Bore hole spacing: 19 mm and 50 mm
Bore hole diameter: 4 mm

P-1002710



P-1002622

Silicone Tube

Silicone, transparent, 1 m long.
Internal diameter: 6 mm
Wall thickness: 2 mm

P-1002622



P-1018449

Holder for Plug-in Components

Holding rod with 4-mm connector sockets to accommodate and connect components with two plugs matching a 19-mm or 50-mm grid or conductor loops for verifying the Biot-Savart law. Suitable for both 4-mm laminated plugs as well as 4-mm safety plugs.

Max. continuous current: 25 A
Diameter of rod: 10 mm
Dimensions: 110x20x135 mm³ approx.
Weight: 120 g approx.

P-1018449

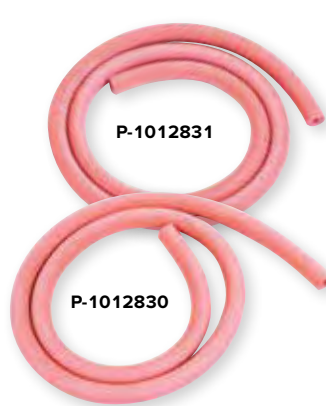

P-1012831

P-1012830

Vacuum Hoses

Vacuum hoses made of natural rubber according to DIN 12865. Colour red.

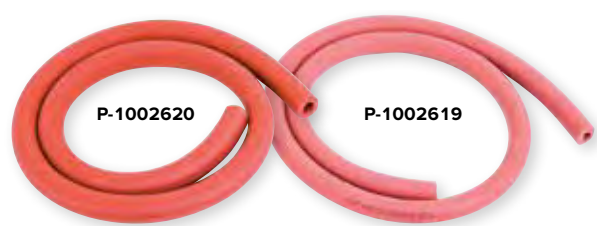

P-1002620

P-1002619

Art. No.	Length	Internal diameter	Wall strength	Temperature range
P-1012831	1 m	4 mm	4 mm	-30° up to +85°
P-1012830	1 m	6 mm	4 mm	-30° up to +85°
P-1002619	1 m	8 mm	5 mm	-30° up to +85°
P-1002620	1 m	10 mm	5 mm	-30° up to +85°

For a reliable connection

Set of 15 Experiment Leads, 75 cm

Set of 15 copper leads with highly-flexible PVC insulation, 75 cm long, with stackable 4 mm laminated plugs at both ends. Five leads in each of the colours red, black and blue.

Voltage: Safety extra low voltage
Plugs and sockets: Nickel-plated

Art. No.	Conductor cross-section	Max. continuous current
P-1002840	1 mm ²	19 A
P-1002841	2.5 mm ²	32 A

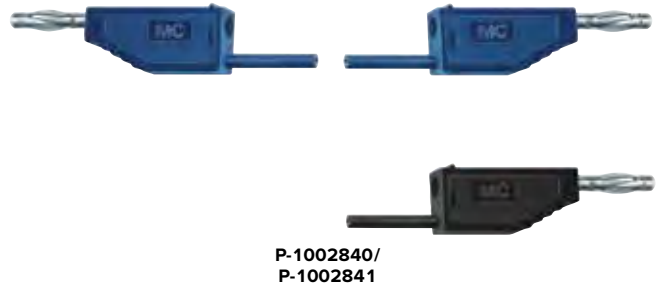

Set of Experiment Leads for Electron Tube Experiments

Set of 18 copper leads with highly flexible PVC insulation for all connections to series D electron tubes.

Wire cross-section: 1 mm²
Max. continuous current: 19 A
Plug and jack: 4 mm (nickel-plated)

P-1002847

Quantity	Length	Colour	Connection
3	75 cm	red	Safety jack/plug
4	75 cm	blue	Plug/plug
2	75 cm	black	Plug/plug
2	50 cm	blue	Plug/plug
5	25 cm	black	Plug/plug
2	25 cm	red	Plug/plug



Experiment Lead, Plug and Socket

Experiment lead with 4 mm laminated plug and 4 mm socket. 75 cm long, colour red.

Wire cross-section: 1 mm²
Max. continuous current: 19 A

P-1002838

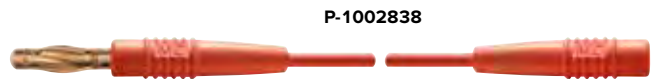

Experiment Lead, Safety Plug and Socket

Experiment lead with stackable 4 mm safety-grade laminated plug and 4 mm socket. 75 cm long, colour red.

Wire cross-section: 1 mm²
Max. continuous current: 19 A

P-1002839



Set of 10 Crocodile Clips 4 mm, Not Insulated

Not insulated test clips with 4 mm sockets for accepting 4 mm-test leads or any other 4 mm-Multilam plug. Connection also possible with screw clamp or soldering.

P-1019219



Pair of Experiment Leads, 75 cm

Set of two copper leads with highly flexible PVC insulation, 75 cm long, black, with cascading 4 mm laminated plugs at both ends.

Conductor cross-section: 1 mm²
Voltage: Safety extra low voltage
Max. continuous current: 19 A

P-1002850

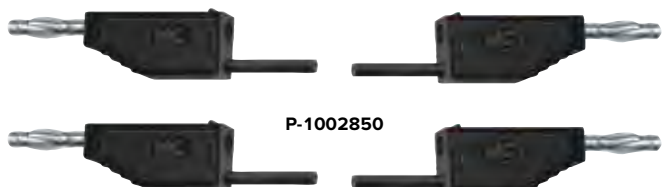

Safety First

Set of 6 Safety Crocodile Clips 4 mm

Fully insulated safety crocodile clips (3x red, 3x black) with 4 mm safety socket for accepting 4 mm safety test leads or any other 4 mm Multilam plug.

P-1019218



P-1019218



P-1019218

Pair of High-Voltage Cables, 150 cm

Set of two copper leads sheathed in highly flexible PVC, 150 cm long with 4-mm safety plugs at either end housed in rigid insulating sleeves. One red cable and one black.

Cable cross section: 0.5 mm²

Voltage: Up to 5 kV

P-1002851



P-1002851

Set of Fuses

Set of fuses, including 105 fast-acting fuses of a high switching capacity and 135 slow-acting fuses of a low switching capacity. Stored in a box.

Dimensions: 5 mm diam. x 20 mm

Rated voltage: 250 V

Type SP:

Material: Glass tube

Time response: Fast

Switching capacity: 1000 A @ 250 V

Assortment: 1 A (15 units); 3.15 A; 6.3 A; 10 A (30 units in each case)

Type FST:

Material: Ceramic tube

Time response: Slow

Switching capacity: 35 A @ 250 V

Assortment: 0.5 A; 1 A; 1.25 A; 1.6 A; 2 A; 2.5 A; 3.15 A; 6.3 A; 10 A (15 units each)

P-1012873

P-1012873

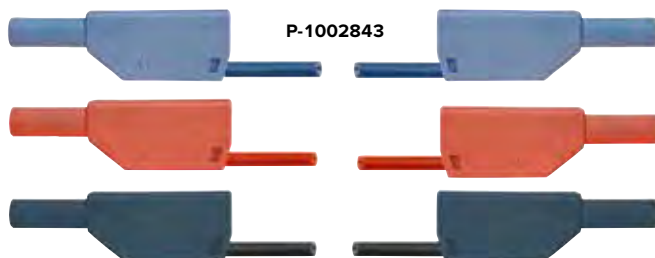

P-1002843

Set of 15 Safety Experiment Leads, 75 cm

Set of 15 copper leads with highly-flexible PVC insulation, 75 cm long, with stackable 4 mm safety laminated plugs at both ends. Four leads in each of the colours red, black and blue, and one lead in each of the colours green, brown and yellow-green.

Wire cross-section: 2.5 mm²

Voltage: Low voltage

Max. continuous current: 32 A

P-1002843

Safety Experiment Leads, 75 cm (not shown)

Copper leads in highly flexible PVC insulation, 75 cm long, black, with stackable 4 mm safety laminated plugs at both ends.

Conductor cross-section: 2.5 mm²

Voltage: Safety extra low voltage

Max. continuous current: 32 A

Pair of Safety Experiment Leads, 75 cm, black

P-1002849

Pair of Safety Experiment Leads, 75 cm, red

P-1017716

Pair of Safety Experiment Leads, 75 cm, blue, red

P-1017718

Set of Three Safety Experiment Leads, 75 cm, yellow/green, blue, black

P-1017719

Set of Three Safety Experiment Leads for Free-Fall Apparatus (not shown)

Set of three copper leads with highly flexible PVC insulation for connecting to free-fall apparatus (P-1000738), with stackable 4 mm safety laminated plugs at both ends. Two leads 75 cm long, one red and one black. One green lead, 150 cm long.

Wire cross-section: 2.5 mm²

Voltage: Low voltage

Max. continuous current: 32 A

P-1002848



Experiment Leads and Cables

Lab Material

For high-frequency signals

T-Piece, BNC

T-piece for connecting two high-frequency patch cords to one BNC jack.

P-1002752

Adaptor, BNC Plug/4 mm Jacks

Crossover from a BNC plug to 4 mm jacks with 19 mm spacing.

P-1002750

Adaptor, BNC Jack/4-mm-Plugs

Crossover from a BNC jack to 4 mm plugs with 19 mm spacing.

P-1002751

BNC Patch-Cord Connector

Coupling at either end with a BNC jack for connecting high-frequency patch cords.

P-1002749

HF-Patch Cord

Shielded patch cords for low loss, low capacitance transmission of high frequency signals. Equipped at either end with a BNC plug.

Impedance: 50 Ω

Length: 1 m

P-1002746

HF Patch Cord, BNC/4 mm Plug

Shielded patch cord for low loss, low capacitance transmission of high frequency signals. Lead with a BNC plug at one end and two 4 mm plugs at the other end.

Impedance: 50 Ω

Length: 1 m

P-1002748

Ultrasonic Adaptor Lead

Adaptor lead for rectifying high-frequency output signals from the ultrasonic electronic control unit in order to conduct measurements with any DC voltmeter. The ultrasonic electronic control unit is part of ultrasonic equipment sets used in student experiments.

Input: BNC plug

Output: 2 x 4-mm plugs

Length: 65 cm

Weight: 20 g approx.

P-1018750

Pellets

Granules for filling calorimeters.

Aluminium Shot, 100 g

P-1000832

Copper Shot, 200 g

P-1000833

Glass Shot, 100 g

P-1000834



Adaptor, BNC Plug/4 mm Safety Jacks

Crossover from a BNC plug to 4 mm safety jacks with 19 mm spacing.

P-1010181

Indigo Solution

30 ml indigo solution in a flask, for colouring water in demonstration experiments.

P-1000793

Glycerine

250 ml of glycerine in aqueous solution for experiments on viscosity. In glass bottle
Concentration: 85%

P-1007027



P-1002869

P-1003190

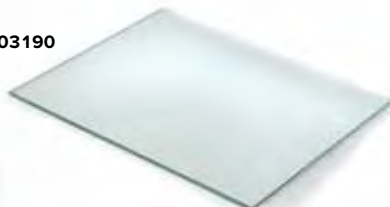
**Plane Mirror**

Glass mirror, ground edges.
Dimensions: approx.
170x130 mm²

P-1003190

P-1002868

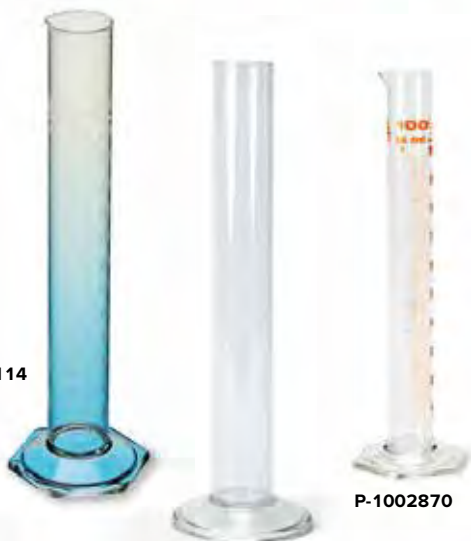

P-1010114

P-1002870

P-1002871

Watch Glass Dishes

Made of thin-walled soda-glass, ground rim. Diameter 80 mm or 120 mm.

Art. No.	Designation
P-1002868	Set of 10 Watch Glass Dishes, 80 mm
P-1002869	Set of 10 Watch Glass Dishes, 120 mm

Graduated Cylinder, 250 ml

Graduated cylinder made of borosilicate glass. Tall form with spout and hexagonal base.
Scale: 250 ml
Divisions: 2.5 ml

P-1010114

Free-Standing Cylinder

Non-graduated cylinder made of Duran glass. With round base and coarse ground rim.
Height: 300 mm
Diameter: 40 mm

P-1002871

Graduated Cylinder, 100 ml

Graduated cylinder made of Duran glass. Tall form with spout with hexagonal base.
Scale: 100 ml
Divisions: 1 ml

P-1002870

Vessel with Overflow

Vessel with overflow, 275 ml, made of acrylic.

P-1003518



P-1002873

P-1002872

P-1003518

Beakers, 600 ml

Set of 10 beakers made of borosilicate glass. With scale, 100 ml divisions and spout.

Art. No.	Designation
P-1002872	Set of 10 Beakers, Low Form
P-1002873	Set of 10 Beakers, Tall Form

Round-Bottomed Flask (not shown)

Round-bottomed flask made of borosilicate glass.

Art. No.	Designation
P-1011768	Round-Bottomed Flask, 250 ml
P-1011769	Round-Bottomed Flask, 500 ml

Plastic Trough (not shown)

Transparent plastic trough.
Dimensions: 70x130x85 mm³

P-4000036



P-1003534

Cuvette, Rectangular, 80x30x80 mm³

Plane-parallel cuvette of acrylic with highly-polished optical surfaces for investigating the paths of light beams in liquids.
Dimensions: 80x30x80 mm³

P-1003534



P-1018065

DIN-B Burette with Schellbach Stripe, 10 ml

Burette tube for measuring small amounts of liquid with Schellbach stripe and tap at the side with standard ground (NS) glass connector and cock plug.

Volume: 10 ml
Scale divisions: 0.02 ml
Error limits: Class B

P-1018065

Resonance Bowl

Dating from the Song Dynasty (960 – 1279 A.D.), this bronze basin has two prominent handles and four fish in relief on the bottom, as well as lines emanating from the mouths or tails of the fish. When the handles are rubbed briskly with the palms of the hands, a harmonious sound is heard and standing waves are excited in the four quadrants along the circumference, causing water columns to come alive, spouting more than 30 cm into the air, as if squirting from the fish.

Diameter: approx. 380 mm
 Height: approx. 150 mm

P-1003206

P-1003206



Pythagorean Cup

Pythagoras is known to most students today as the author of the Pythagorean Theorem ($a^2 + b^2 = c^2$). There was far more to Pythagoras' philosophy than this: he was a deep thinker on religion, the nature of the soul, and the harmony of the cosmos. With the "Pythagorean Cup" he illustrated to his students the virtues of moderation: when filled halfway, it retains its contents, but if it's too full, all of the liquid drains out through a hole in the bottom. Our Pythagorean cup is manufactured of clear blown glass. The secret of the construction is a siphon, which is built in the centre of the cup. Ideal to explain to your students the principle of a siphon with an historical background.

Height: approx. 250 mm
 Diameter: approx. 80 mm

P-1002904

P-1002904

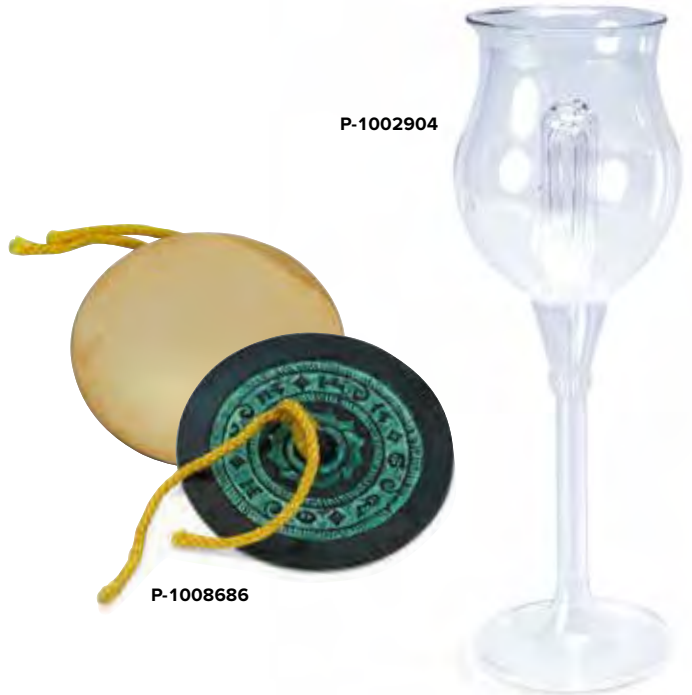

Magic Mirror

The Western Han "Light-Transmitting" Mirror known as the magic mirror has a history of more than two thousand years. It is a miracle created by the ingenious Chinese craftsmen in Western Han Dynasty (206 B.C. – 24 A.D.) through combining the optical and mechanical principles with superb metallurgical technology. Those wonderful mirrors are able to reflect the decorative pattern cast on their backs onto a white screen when sunlight is shining on their polished fronts. The fabrication technology of this magic mirror was lost in Song Dynasty (960 – 1279 A.D.) and had remained a mystery until 1975. With a perfect combination of science and technology, culture and art, the celebrated Magic Mirror is a perfect classroom tool as well as a cherished gift.

Diameter: approx. 70 mm
 Thickness: approx. 10 mm

P-1008686

P-1008686



P-1003207

Yi Bell

The "faith bell" is shaped after the two-tone bell unearthed in the tomb of Marquis Yi in 1978. This reproduction has been cast using a newly designed copper alloy containing magnesium and exhibits a unique physical property resulting from a combination of bell design and the effect of temperature on vibrational damping. At room temperature the bell exhibits excessive damping and gives a dull sound when struck, as though it were made of wood. After being heated with an alcohol burner for several minutes, the bell is restruck and rings beautifully.

Dimensions: approx. 295x210x120 mm³

P-1003207

Description	Art. No.	Page	Description	Art. No.	Page
3B NET/ab™	P-1000544	38	Apparatus for Measuring Young's Modulus	P-1018527	89
3B NET/og™ (115 V, 50/60 Hz)	P-1000539	39	Archimedes Cup	P-1018836	83
3B NET/og™ (230 V, 50/60 Hz)	P-1000540	39	Areometers, Set of 3	P-1003012	84
3B NET/og™ with Ethernet Port (115 V, 50/60 Hz)	P-1000541	39	Arm Phantom Set	P-1012880	118
3B NET/og™ with Ethernet Port (230 V, 50/60 Hz)	P-1000009	39	Assembly Kit "Bell, Relay and Bimetallic Switch"	P-1000994	204
3B POWER/og (115 V, 50/60 Hz)	P-1000542	46	Astronomy	–	56
3B POWER/og (230 V, 50/60 Hz)	P-1000543	46	Atomic and Nuclear Physics	–	246 – 265
3B Student Kit	–	8 – 14	Atomic Orbitals	–	250
6-Piece Model of a Human Eye	P-1000259	191	Atwood's Machine	P-1003367	70
			Auto Focus Vision Viewer™	P-1012834	292 – 293
			Auxiliary Coil	P-1000645	236
– A –			– B –		
Absolute Pressure Sensor, 2500 hPa	P-1000546	43	Balance Weights	–	54
AC/DC Power Supply 0 – 12 V, 3 A (115 V, 50/60 Hz)	P-1002775	268	Ball and Ring	P-1003382	130
AC/DC Power Supply 0 – 12 V, 3 A (230 V, 50/60 Hz)	P-1002776	268	Ball with Ring	P-1000831	130
AC/DC Power Supply 0 – 12 V, 3 A, stab. (115 V, 50/60 Hz)	P-1001006	268	Ballistic Pendulum	P-1002656	69
AC/DC Power Supply 0 – 12 V, 3 A, stab. (230 V, 50/60 Hz)	P-1001007	268	Balloons, Set of 100	P-1010125	90
AC/DC Power Supply 0 – 20 V, 0 – 5 A (115 V, 50/60 Hz)	P-1003561	268	Band Wave Device	P-1000808	101
AC/DC Power Supply 0 – 20 V, 0 – 5 A (230 V, 50/60 Hz)	P-1003562	268	Bar Magnet, AlNiCo, 70 mm	P-1003554	214
AC/DC Power Supply 0 – 30 V, 5 A (230 V, 50/60 Hz)	P-1002769	268	Bar Magnets, 80 mm, Pair	P-1003085	214
AC/DC Power Supply 0 – 30 V, 6 A (115 V, 50/60 Hz)	P-1008692	231, 269	Bar Magnets, AlNiCo, 60 mm, Pair with Two Iron Yokes	P-1003086	214
AC/DC Power Supply 0 – 30 V, 6 A (230 V, 50/60 Hz)	P-1003593	231, 269	Barometer	P-1000549	43
AC/DC Power Supply 1/ 2/ 3/ – 15 V, 10 A (115 V, 50/60 Hz)	P-1008690	269	Baroscope	P-1003169	91
AC/DC Power Supply 1/ 2/ 3/ – 15 V, 10 A (230 V, 50/60 Hz)	P-1008691	269	Barrel Foot, 1000 g	P-1002834	296
Acceleration Sensor, ±25g	P-1000560	41	Barrel Foot, 500 g	P-1001046	296
Acceleration Sensor, ±5g	P-1000561	41	Barrel Foot, 900 g	P-1001045	296
Accessories for Faraday Effect	P-1012861	168	Basic Equipment Set for the X-Ray Apparatus	P-1000665	258c
Accessories for Kinetic Gas Theory	P-1000704	139	Basic Experiment Board (115 V, 50/60 Hz)	P-1000572	205
Accessories for Rope Waves	P-1008540	100	Basic Experiment Board (230 V, 50/60 Hz)	P-1000573	205
Accessories for Spring Oscillations	P-1000703	100	Basic Set Bragg	P-1008508	258c
Accessory Set for the Interferometer	P-1002652	183	Basic Set for Kröncke Optical System (115 V, 50/60 Hz)	P-1009931	32 – 33
Achromatic Objective 10x / 0.25	P-1005408	156	Basic Set for Kröncke Optical System (230 V, 50/60 Hz)	P-1009932	32 – 33
Acoustics Kit	P-1000816	15	Basic Student Experiments	–	34
Acrylic Body with Drilled Holes	P-1002589	115	Battery Holder in 3B Box	P-1010192	200 – 201
Acrylic Puck	P-1003362	65	Battery Holder, P4W50	P-1012994	209
Adaptor Cables 4-mm/2-mm Plug, Pair of	P-1017899	128	Beakers, Low Form, Set of 10	P-1002872	302
Adaptor Flange DN 16 KF / NS 19/26	P-1002929	93	Beakers, Tall Form, Set of 10	P-1002873	302
Adaptor Flange DN 16 KF / Shaft 12 mm	P-1002928	93	Beam Balance	P-1018834	55
Adaptor, BNC Jack/4-mm Plugs	P-1002751	301	Bench Scales, Harvard Junior	P-1012872	55
Adaptor, BNC Plug/4 mm Jacks	P-1002750	301	Bicycle Dynamo, Transparent	P-1010164	227
Adaptor, BNC Plug/4 mm Safety Jacks	P-1010181	301	Bicycle Wheel Gyroscope	P-1003489	74
Addition of Colours School Apparatus	P-1012821	171	Binaural Hearing	–	107
Additional Coil for Tesla Transformer	P-1000967	231	Binocular Polarisation Microscope	P-1012404	294
Additional Weights f. Mechanical Balance	P-1014616	288	Biot-Savart	–	221
Adjustable Double Clamp	P-1017870	297	Block and Tackle, Experiment Set	P-1003224	59
Adjustable Slit K	P-1008519	150 – 151	Block for Friction Experiments	P-4003876	58
Adjustable Slit on Stem	P-1000856	158	BNC Patch Cord Connector	P-1002749	301
Aerodynamics	–	94	Board for Laser Ray Box	P-1003056	148
Air Cushion Plate	P-1002981	137	Bodies for Air Resistance and Buoyancy Experiments, Set	P-1000760	94
Air Cushion Table (230 V 50/60 Hz)	P-1013210	64	Bolometer	P-1000840	121
Air Cushion Table (115 V 50/60 Hz)	P-1012569	64	Bosshead	P-1002827	297
Air Flow Apparatus	P-1000765	95	Boyle-Mariotte Apparatus	P-1017366	140
Air Flow Generator (115 V, 50/60 Hz)	P-1000605	63, 94	Bragg Drive	P-1012871	258d – e
Air Flow Generator (230 V, 50/60 Hz)	P-1000606	63, 94	Brass Wire 0.3 mm / 50 m	P-1000959	198
Air Track	P-1019299	62 – 63	Bravais Lattices, Set of 14	P-1012837	248 – 249
Alcohol Meter	P-1002875	84	Breast Model with Benign Tumor	P-1000345	116
Alignment Laser Diode	P-1008634	184 – 187	Broken Down Cubic Decimetre	P-1010121	51
Aluminium Plates, Set of 10	P-1002716	213	Buffer Solution	P-1002753	45
Aluminium Puck	P-1003363	65	Bulbs E10, 1.3 V, 60 mA, Set of 10	P-1010199	199
Aluminium Shot, 100 g	P-1000832	301	Bulbs E10, 12 V, 100 mA, Set of 10	P-1010140	199
Aluminium Test Block with Protractor Scale	P-1002585	114	Bulbs E10, 12 V, 500 mA, Set of 10	P-1010141	199
Aluminium Calorimeter	P-1017897	128	Bulbs E10, 3.5 V, 150 mA, Set of 10	P-1010142	199
Amici Direct Vision Prism	P-1002862	167	Bulbs E10, 3.5 V, 200 mA, Set of 10	P-1010143	199
Ammeter, AC	P-1002788	278	Bulbs E10, 3.8 V, 300 mA, Set of 10	P-1010195	199
Ammeter, DC	P-1002786	278	Bulbs E10, 4 V, 40 mA, Set of 10	P-1010196	199
Amplifier	–	287	Bulbs E10, 6 V, 1 A, Set of 10	P-1010198	199
Analogue Multimeter AM50	P-1003073	278	Bulbs E10, 6 V, 100 mA, Set of 10	P-1010145	199
Analogue Multimeter AM51	P-1003074	278	Bulbs E10, 6 V, 350 mA, Set of 10	P-1010144	199
Analogue Multimeter ESCOLA 100	P-1013527	279	Bulbs E10, 6 V, 50 mA, Set of 10	P-1010197	199
Analogue Multimeter ESCOLA 30	P-1013526	279	Buoyancy Apparatus	P-1000791	83
Analogue Oscilloscope, 1x10 MHz (230 V, 50/60 Hz)	P-1002745	275	Button on 3B Box	P-1010146	200 – 201
Analogue Oscilloscope, 2x20 MHz (230 V, 50/60 Hz)	P-1008695	275	– C –		
Analogue Oscilloscope, 2x30 MHz	P-1002727	275	Calcite Crystal	P-5006663	167
Analytical Scales AES200 (230 V, 50/60 Hz)	P-1018347	289	Callipers Model	P-1010214	51
Aneroid Barometer F	P-1010232	123	Callipers S	P-1010217	50
Apertures, Optical	–	161 – 165	Callipers, 150 mm	P-1002601	50
Apparatus for Investigation of Capillary Effects	P-1003510	87	Calorimeter 200 ml	P-1000823	128
			Calorimeter Cylinder, Al	P-1003254	129
			Calorimeter Cylinder, Brass	P-1003255	129
			Calorimeter Cylinder, Cu	P-1003256	129
			Calorimeter Cylinder, Steel	P-1003257	129
			Calorimeter Cylinders, Set of 4	P-1003253	129
			Calorimeter with Heating Coil, 1200 ml	P-1000821	129
			Calorimeter with Heating Coil, 150 ml	P-1000822	129
			Calorimeters	–	129

Description	Art. No.	Page
Capacitance Decade	P-1013906	204
Capacitance Decade 0.1 μF	P-1002736	203
Capacitance Decade 1 μF	P-1002737	203
Capacitor 0.1 μF , 100 V, P2W19	P-1012953	206
Capacitor 0.22 μF , 250 V, P2W19	P-1012945	206
Capacitor 0.47 μF , 100 V, P2W19	P-1012954	206
Capacitor 1 μF , 100 V, P2W19	P-1012955	206
Capacitor 1 nF, 100 V, P2W19	P-1012949	206
Capacitor 10 μF , 35 V, P2W19	P-1012957	206
Capacitor 10 nF, 100 V, P2W19	P-1012952	206
Capacitor 100 μF , 35 V, P2W19	P-1012959	206
Capacitor 100 pF, 160 V, P2W19	P-1012947	206
Capacitor 1000 μF , 35 V, P2W19	P-1017806	206
Capacitor 2.2 μF , 63 V, P2W19	P-1012956	206
Capacitor 2.2 nF, 160 V, P2W19	P-1012950	206
Capacitor 22 nF, 100 V, P2W19	P-1012943	206
Capacitor 2200 μF	P-1000689	202
Capacitor 4.7 μF , 63 V, P2W19	P-1012946	206
Capacitor 4.7 nF, 100 V, P2W19	P-1012951	206
Capacitor 47 μF , 35 V, P2W19	P-1012958	206
Capacitor 47 nF, 100 V, P2W19	P-1012944	206
Capacitor 470 μF , 16 V, P2W19	P-1012960	206
Capacitor 470 pF, 160 V, P2W19	P-1012948	206
Capacitor Plates 125 cm^2 , Pair of	P-1000934	197
Capacitor Plates 250 cm^2 , Pair of	P-1000933	197
Capacitor Plates 500 cm^2 , Pair of	P-1000932	197
Carbon Configurations, Set of 3	P-1012836	248 – 249
Carbon Electrodes	P-1003508	212
Carbon Plates, Set of 5	P-1002717	213
Cardboard Plate	P-1000936	197
Cartesian Diver	P-1002867	83
Cast Iron Bolts, Set of 10	P-1000827	130
Castor Oil	P-1002671	139
Cathode Ray Tube	P-1000901	243
Cavendish Torsion Balance	P-1003337	56
CCD HD Sensor	P-1018820	172 – 173
Cell Holder on Stem	P-1002721	175
Centre of Gravity Plate	P-1008513	57
Centrifugal Pump	P-1002575	117
Change-Over Switch (SPDT) on 3B Box	P-1012694	200 – 201
Change-Over Switch, Double Pole, P4W50	P-1012991	208
Chaotic Pendulum E	P-1017531	76
Charge and Discharge Apparatus (115 V, 50/60 Hz)	P-1017780	210
Charge and Discharge Apparatus (230 V, 50/60 Hz)	P-1017781	210
Charge Indicator	P-1009962	193
Charge Spoon, Large	P-1002708	194
Charge Spoon, Small	P-1002707	194
Charge Storage Device with Piezo Charger	P-1009963	193
Chladni Plate, Circular	P-1000705	101
Chladni Plate, Square	P-1000706	101
Chrome-Nickel Wire 0.5 mm / 50 m	P-1000954	198
Chrome-Nickel Wire 0.3 mm / 100 m	P-1000953	198
Clamp for Projectile Launcher	P-1002655	68
Clamp K	P-1008518	150 – 151
Clamp with Hook	P-1002828	297
Clamp with Jaw Clamp	P-1002829	297
Clamps D, Pair	P-1000977	230
Cloud Chamber	P-1000921	260
Coil D with 1200 Taps	P-1000989	228
Coil D with 600 Taps	P-1000988	228
Coil D with 6000 Taps	P-1000990	228
Coil D, 900 Turns	P-1012859	229
Coil on Acrylic Base	P-1000928	219
Coil S with 1200 Taps	P-1001002	230
Coil S with 2400 Taps	P-1001003	230
Coil S with 600 Taps	P-1001000	230
Coil S with 800 Taps	P-1001001	230
Coil Spring Slinky	P-1003516	99
Coil Springs	–	53
Coil with 600 Windings on 3B-Box	P-1011346	200 – 201
Coil with Variable Number of Turns per Unit Length	P-1000965	220
Coil, 10 mH, P2W19	P-1012983	207
Collimator lens $f = +75$ mm	P-1008646	184 – 187
Colour	–	170 – 171
Colour Filters, Primary Colours, Set of 3	P-1003185	165
Colour Filters, Secondary Colours, Set of 3	P-1003186	165
Colour Filters, Set of 7	P-1003084	165
Colour Mixing, Equipment Set	P-1003189	171
Communicating Tubes	P-1003509	87
Compass	P-1003093	217
Compass Magnet with Plastic Bowl	P-1003096	215
Complete Fine Beam Tube System T	P-1013843	245
Component Balance	P-1000761	94
Component Holder	P-1003203	158
Components for Electronics Experiments, Set of	P-1018532	209
Computer Tomography	–	119
Computer-Aided Experimentation	–	38 – 47

Description	Art. No.	Page
Concave Lens K, $f = -100$ mm	P-1009864	150 – 151
Concave Lens K, $f = -500$ mm	P-1009865	150 – 151
Concave Lens N, $f = -100$ mm	P-1000844	152
Concave Lens on Stem $f = -100$ mm	P-1003028	157
Concave Lens on Stem $f = -200$ mm	P-1003029	157
Concave Mirror K	P-1009925	150 – 151
Concave Mirror on Stem +75 mm	P-1003031	157
Conducting Sphere, $d = 30$ mm, with 4 mm Plug	P-1001026	194
Conducting Sphere, $d = 85$ mm, with 4 mm Plug	P-1000938	194
Conductivity Electrode	P-1012889	213
Conductivity Sensor	P-1000553	45
Conductivity Standards, Set of 3	P-1000552	45
Conductivity Tester	P-1012890	213
Conductors and Non-Conductors, Set of Conductors for Biot-Savart Experiments, Set of 4	P-1018478	221
Conductors in Magnetic Fields	–	222 – 227
Connecting Lead with Two Metal Rods	P-1017344	106
Connector Box (115 V, 50/60 Hz)	P-1009954	40
Connector Box (230 V, 50/60 Hz)	P-1009955	40
Constant Velocity Student Kit, 3 Tubes	P-1003502	34
Constant Velocity Student Kit, 4 Tubes	P-1018624	34
Constantan Wire 0.4 mm / 50 m	P-1000957	198
Constantan Wire 0.3 mm / 100 m	P-1000956	198
Constantan Wire 0.5 mm / 50 m	P-1000958	198
Constantan Wire 0.2 mm / 100 m	P-1000955	198
Contact Stand with Terminal Sockets	P-1000995	199
Control Unit for Critical Potential Tubes (115 V, 50/60 Hz)	P-1000633	256 – 257
Control Unit for Critical Potential Tubes (230 V, 50/60 Hz)	P-1008506	256 – 257
Control Unit for Spectrum Lamps (115 V, 50/60 Hz)	P-1003195	176
Control Unit for Spectrum Lamps (230 V, 50/60 Hz)	P-1003196	176
Convex Concave Mirror, $f = \pm 100$ mm	P-1002985	146
Convex Lens K, $f = 100$ mm	P-1010300	150 – 151
Convex Lens K, $f = 150$ mm	P-1000871	150 – 151
Convex Lens K, $f = 200$ mm	P-1009861	150 – 151
Convex Lens K, $f = 300$ mm	P-1009866	150 – 151
Convex Lens K, $f = 50$ mm	P-1000869	150 – 151
Convex Lens K, $f = 500$ mm	P-1009863	150 – 151
Convex Lens N, $f = 100$ mm	P-1000842	152
Convex Lens N, $f = 300$ mm	P-1000841	152
Convex Lens N, $f = 50$ mm	P-1000843	152
Convex Lens on Stem $f = +100$ mm	P-1003023	157
Convex Lens on Stem $f = +150$ mm	P-1003024	157
Convex Lens on Stem $f = +150$ mm	P-1003027	157
Convex Lens on Stem $f = +200$ mm	P-1003025	157
Convex Lens on Stem $f = +300$ mm	P-1003026	157
Convex Lens on Stem $f = +50$ mm	P-1003022	157
Convex Mirror on Stem -75 mm	P-1003032	157
Copper Calorimeter	P-1002659	128
Copper Plates, Set of 10	P-1002712	213
Copper Sample for Hall Effect	P-1018751	265
Copper Shot, 200 g	P-1000833	301
Copper Wire 0.3 mm / 100 m	P-1000949	198
Copy of a Rowland Grating	P-1002917	162
Cord for Experiments	P-1001055	295
Cord, 100m	P-1007112	295
Cork Powder, 10 g Bottle	P-1000815	103
Coulombmeter with Rechargeable Battery	P-1017734	31
Coupled Harmonic Oscillator	P-1003354	63
Cr:YAG Module	P-1008637	184 – 187
Critical Point Apparatus	P-1002670	138
Critical Potential Tube S with He-Filling	P-1000620	256 – 257
Critical Potential Tube S with Ne-Filling	P-1000621	256 – 257
Crocodile Clips 4mm, Not Insulated, Set 10	P-1019219	299
Crocodile Clips on 3B Box	P-1010155	200 – 201
Crookes Radiometer	P-1002882	135
Cross Bosshead	P-1002831	297
Crosspiece DN 16 KF	P-1002924	93
Crown Glass Prism 60°, 27x50 mm	P-1002858	166
Crown Glass Prism 60°, 30x30 mm	P-1002864	166
Crown Glass Prism 60°, 45x50 mm	P-1002859	166
Crown Glass Prism 90°, 30x50 mm	P-1002860	166
Crown Glass Prism 90°, 45x50 mm	P-1002861	166
Crystallography Accessories	P-1000666	258b
CT Controller	P-1017783	119
CT Measuring Trough	P-1017785	119
CT Sample	P-1017784	119
CT Scanner	P-1017782	119
Cubes for Determining Density, Set of 7	P-1000766	85
Current Balance Equipment Set	P-1019188	222
Current Direction Indicator in 3B Box	P-1012697	200 – 201
Cuvette Cells, 4 ml, Set of 100	P-1018106	181
Cuvette, Rectangular, 80x30x80 mm ³	P-1003534	302
Cyclic Processes	–	141 – 145
Cylinders, Equal in Mass, Set of 3	P-1000754	84
Cylinders, Equal in Volume, Set of 3	P-1000752	84
Cylinders, Set of 3	P-1002588	115

Description	Art. No.	Page	Description	Art. No.	Page
Cylindrical Bar Magnet 200x10	P-1003112	214	Digital Thermometer, Min/Max	P-1003010	126
Cylindrical Bar Magnet 50x20	P-1003556	214	Digitale Oscilloscope, 2x100MHz	P-1018583	276 – 277
– D –			Digitale Oscilloscope, 2x25MHz	P-1018581	276 – 277
Daniell Cell	P-1002898	212	Digitale Oscilloscope, 2x40MHz	P-1018582	276 – 277
Darlington-Transistor TIP162, P4W50	P-1018847	209	Digital-Spectrometer HD	P-1018104	180 – 181
DC Power Supply 0 – 16 V, 0 – 10 A (115 V, 50/60 Hz)	P-1002760	270	Digital-Spectrometer LD	P-1018103	180 – 181
DC Power Supply 0 – 16 V, 0 – 10 A (230 V, 50/60 Hz)	P-1002761	270	DIN-B Burette with Schellbach Stripe, 10 ml	P-1018065	195, 302
DC Power Supply 0 – 16 V, 0 – 16 A	P-1002771	270	Diode D	P-1000646	234
DC Power Supply 0 – 20 V, 0 – 5 A (115 V, 50/60 Hz)	P-1003311	270	Diode in 3B Box	P-1010157	200 – 201
DC Power Supply 0 – 20 V, 0 – 5 A (230 V, 50/60 Hz)	P-1003312	270	Diode Laser 1000 mW	P-1009497	184 – 187
DC Power Supply 0 – 300 V (115 V, 50/60 Hz)	P-1001011	271	Diode S	P-1000613	239
DC Power Supply 0 – 300 V (230 V, 50/60 Hz)	P-1001012	271	Displacement Sensor	P-1000568	41
DC Power Supply 0 – 32 V, 0 – 2.5 A (115 V, 50/60 Hz)	P-1002762	270	DMM 1000 Iso-Multimeter	P-1012865	282
DC Power Supply 0 – 32 V, 0 – 2.5 A (230 V, 50/60 Hz)	P-1002763	270	DMM50 Digital Multimeter	P-1012817	282
DC Power Supply 0 – 500 V (115 V, 50/60 Hz)	P-1003307	271	DMM60 Digital Multimeter	P-1012816	282
DC Power Supply 0 – 500 V (230 V, 50/60 Hz)	P-1003308	271	Doppler Phantom Fluid	P-1002574	116
DC Power Supply 1.5 – 15 V, 1.5 A (230 V, 50/60 Hz)	P-1003560	269	Doppler Prisms and Flow Tubes, Set	P-1002572	118
DC Power Supply 450 V (115 V, 50/60 Hz)	P-1008534	269	Doppler Sonography	–	117 – 118
DC Power Supply 450 V (230 V, 50/60 Hz)	P-1008535	269	d-Orbitals, Set of 5	P-1012840	250
DC Power Supply, 1 – 32 V, 0 – 20 A (115 V, 50/60 Hz)	P-1012858	270	Dosimeter Radex RD 1706	P-1012894	260
DC Power Supply, 1 – 32 V, 0 – 20 A (230 V, 50/60 Hz)	P-1012857	270	Double Slits on Glass Plate	P-1003204	164
Demonstration Aneroid Barometer	P-1002627	122	Doubly Refracting Crystal	P-5006663	167
Demonstration Dynamo	P-1003252	225	Drawing Instruments for Whiteboard, Set	P-1002593	295
Demonstration Gratings	P-1003082	162	Drilled Rod	P-1002710	298
Demonstration Polarimeter	P-1002906	174	Drop and Launch Apparatus	P-1000588	70
Demonstration Polariscope	P-1000851	174	Dry Fuel for Steam Engine B	P-1012886	145
Demonstration Thermometer -10 – 110°C	P-1003014	124 – 125	Dual Beam Tube S	P-1000622	240
Demonstration Tuning Fork	P-1000700	108	Dual-Beam Tube D	P-1000654	235
Demonstration Wave Machine, Complete Set	P-1003491	102	Dummy Flange DN 16 KF	P-1002927	93
Demonstration Wave Machine, Single Module	P-1003492	102	Dynamometer 1 kg / 10 N, Colour Coded	P-1003372	52
Demountable Transformer	–	228 – 230	Dynamometer 1 N, Transparent	P-1002698	52
Density and Volume	–	84 – 85	Dynamometer 1 N, with Round Dial	P-1009738	52
Density Bodies, Set of 5	P-1000768	83	Dynamometer 10 N, with Round Dial	P-1009741	52
Density Paradox Set	P-1003498	84	Dynamometer 2 kg / 20 N, Colour Coded	P-1003373	52
Device for Archimedes' Principle	P-1003378	83	Dynamometer 2 N, Transparent	P-1002699	52
Device for Demonstrating the Anomaly of Water	P-1002889	132	Dynamometer 2 N, with Round Dial	P-1009739	52
Diac, BR 100, P2W19	P-1012973	207	Dynamometer 250 g / 2.5 N, Colour Coded	P-1003370	52
Diaphragm with 2 cross gratings	P-1000601	163	Dynamometer 3 kg / 30 N, Colour Coded	P-1003374	52
Diaphragm with 3 Circular Holes and Disc Pairs	P-1000603	163	Dynamometer 5 kg / 50 N, Colour Coded	P-1003375	52
Diaphragm with 3 Double Slits of Different Widths	P-1000596	163	Dynamometer 5 N, Transparent	P-1002700	52
Diaphragm with 3 ruled gratings	P-1000599	163	Dynamometer 5 N, with Round Dial	P-1009740	52
Diaphragm with 3 Single Slits and 1 Double Slit	P-1000885	162	Dynamometer 500 g / 5 N, Colour Coded	P-1003371	52
Diaphragm with 4 Double Slits of Different Spacings	P-1000597	163	Dynamometer 6 N, Transparent	P-1002701	52
Diaphragm with 4 Multiple Slits and Gratings	P-1000598	163	Dynamometers for Demonstrating Hooke's Law	P-1003109	53
Diaphragm with 9 Circular Discs	P-1000889	163	– E –		
Diaphragm with 9 Circular Holes	P-1000891	163	E 10 Lamp Socket, Sideways Facing, P2W19	P-1012986	209
Diaphragm with a Single Slit and Rib	P-1000602	162	E 10 Lamp Socket, Upwards Facing, P2W19	P-1012987	209
Diffraction Apertures on Glass Plate	P-1008664	164	E10 Lamp Socket on 3B Box	P-1010138	200 – 201
Diffraction Elements, Optical	–	162 – 164	E10 Lamp Sockets, Set of 10	P-1010137	199
Diffraction Gratings on Glass Plate	P-1014621	164	E14 Lamp Socket on Stem	P-1000853	156
Diffraction Tube S	P-1013889	240	E27 Lamp Socket on Stem	P-1000854	156
Digital Callipers, 150 mm	P-1002602	50	ECG/EMG Box	P-1000579	44
Digital Counter (115 V, 50/60 Hz)	P-1001032	49, 259, 284	Ecoflam Pellets, Set of 60	P-1010255	291
Digital Counter (230 V, 50/60 Hz)	P-1001033	49, 259, 284	Elastic Balls with Plotting Electrode, Pair	P-1000779	66
Digital Counter with Interface (115 V, 50/60 Hz)	P-1003122	285	Elastic Deformation	–	89
Digital Counter with Interface (230 V, 50/60 Hz)	P-1003123	285	Elastic Modulus	–	89
Digital Counters	–	284 – 285	Electric Doorbell	P-1003170	91
Digital Energy Meter	P-1002802	283	Electric Field Meter (115 V, 50/60 Hz)	P-1001029	196
Digital Hygro-Thermometer	P-1003011	122	Electric Field Meter (230 V, 50/60 Hz)	P-1001030	196
Digital Input Box	P-1000571	46	Electric Motor and Generator, Complete	P-1017801	224
Digital Luxmeter	P-1002779	283	Electrical Burner LAB2 (230 V, 50 Hz)	P-1010252	291
Digital Mini Multimeter	P-1002783	280	Electrical Burner LAB3 (230 V, 50 Hz)	P-1010253	291
Digital Multimeter E	P-1006809	281	Electrical Circuits	–	198 – 205
Digital Multimeter P1035	P-1002781	280	Electricity and Magnetism	–	192 – 245
Digital Multimeter P3320	P-1002784	281	Electrochemistry	–	211 – 213
Digital Multimeter P3340	P-1002785	280	Electrochemistry Case	P-1002719	211
Digital Multimeter P3415	P-1008631	281	Electrochemistry, Equipment Set for	P-1002711	213
Digital Oscilloscope 4x60 MHz	P-1008676	276 – 277	Electrodes for ECG/EMG, Set of 30	P-5006578	44
Digital Output Box	P-1000570	46	Electrolytic Trough	P-1009884	195
Digital Pocket Anemometer	P-1010250	123	Electromagnetic Launch Apparatus	P-1019300	62 – 63
Digital Pocket Thermometer	P-1003335	126	Electromagnetism, Equipment Set	P-1002661	222 – 223
Digital Quick Response Pocket Thermometer	P-1002803	124 – 125	Electrometer (115 V, 50/60 Hz)	P-1001024	194
Digital Spectrometer LD with Absorption Chamber	P-1019196	180 – 181	Electrometer (230 V, 50/60 Hz)	P-1001025	194
Digital Stopwatch	P-1002811	49	Electrometer Accessories	P-1006813	194
Digital Stroboscope (115 V, 50/60 Hz)	P-1003330	285	Electrometer Box	P-1000569	43
Digital Stroboscope (230 V, 50/60 Hz)	P-1003331	285	Electron Deflection Tube D	P-1000651	232
Digital Thermometer, 1 Channel	P-1002793	127	Electron Diffraction Tube D	P-1013885	232
Digital Thermometer, 2 Channels	P-1002794	127	Electron Tubes	–	232 – 245
			Electronic Scale 200 g	P-1003433	288
			Electronic Scale 5000 g	P-1003434	288
			Electronic Scale Scout Pro 200 g	P-1009772	289
			Electronic Scale Scout Pro 400 g	P-1003428	289
			Electronic Scale Scout Pro 600 g	P-1003429	289
			Electroscope	P-1003048	193
			Electroscope S	P-1009964	193
			Electrostatic Equipment Set	P-1000924	192
			Electrostatics	–	192 – 197
			ELV Motor on 3B Box	P-1010158	200 – 201
			Energy and the Environment	–	120 – 123
			Equipment Kit "Hysteresis Curve"	P-1018889	215

Description	Art. No.	Page
Equipment Set "Ultrasound in Solids"	P-1002584	114
Equipment Set Electromagnetism	P-1002661	222 – 223
Equipment Set for Colour Mixing	P-1003189	171
Equipment Set for Electrochemistry	P-1002711	213
Equipment Set for Laser Communication	P-1003055	189
Equipment Set for Powder Tracing	P-1000739	66
Equipment Set for Wave Optics with Laser	P-1003053	169
Equipment Set for Waveguide Optics	P-1003054	189
Equipment Set Optics with Laser Ray Box	P-1003049	148
Equipment Set "Stereophonic Hearing"	P-1018551	107
Equipment Set "Sound Propagation in Rods" (115 V, 50/60 Hz)	P-1018468	107
Equipment Set "Sound Propagation in Rods" (230 V, 50/60 Hz)	P-1018469	107
Equipment Sets for Optics	–	188 – 189
Equivalent of Heat	–	128
ESCOLA	–	279
ESR Supplementary Set	P-1000640	262 – 263
ESR/NMR	–	262 – 263
ESR/NMR Basic Set (115 V, 50/60 Hz)	P-1000637	262 – 263
ESR/NMR Basic Set (230 V, 50/60 Hz)	P-1000638	262 – 263
Exp.: Simple Electric Circuit	P-1013825	200 – 201
Experiment Lead, Plug and Socket	P-1002838	299
Experiment Lead, Safety Plug and Socket	P-1002839	299
Experiment Leads and Cables	–	299 – 301
Experiment Leads for Electron Tube		
Experiments, Set of	P-1002847	299
Experiment Leads, 75 cm, 1 mm ² , Set of 15	P-1002840	299
Experiment Leads, 75 cm, 2.5 mm ² , Set of 15	P-1002841	299
Experiment Leads, 75 cm, Pair	P-1002850	299
Experiment Motor with Gearbox	P-1002663	227
Experiment Set Pulleys and Block and Tackle	P-1003224	59
Experimental Lamp, Halogen	P-1003038	155
Extension Arm D	P-1002646	155
External Centring Ring DN 10/16 KF	P-1002931	93
External Micrometer	P-1002600	50
Extra Pulley	P-1000699	57
Eye and Vision	–	191
– F –		
Falling Sphere Viscometer	P-1012827	88
Faraday Cup	P-1000972	194
FET Transistor, BF 244, P4W50	P-1012978	208
Field Coil 100 mm	P-1000591	220
Field Coil 120 mm	P-1000592	220
Filmpack 2	P-1000669	258h
Filmpack 4	P-1000670	258h
Filter BG40	P-1017874	184 – 187
Filter RG850	P-1008648	184 – 187
Filters, Optical	–	165
Fine Beam Tube on Connection Base	P-1000904	244
Fine Beam Tube T	P-1008505	245
Fishing Line, 10 m	P-4009036	295
Five-Beam Lamp	P-1003187	149
Flat Coil in a Rotatable Frame	P-1013131	225
Flat Coils, Pair	P-1000942	218
FlexCam® 2	P-1012835	292 – 293
Flexible Magnetic Field Sensor	P-1012892	286
Flint Glass Block for Faraday Effect	P-1012860	168
Flint Glass Prism 60°, 30x30 mm	P-1002865	166
Fluorescence of Sodium	–	258
Fluorescence Samples, Set	P-1012868	258h
Fluorescence Samples, Set of	P-1012868	258h
f-Orbitals, Set of 7	P-1012838	250
Force Sensor, ±50 N	P-1000557	41
Force Table	P-1000694	57
Foucault Pendulum (115 V, 50/60 Hz)	P-1000747	80
Foucault Pendulum (230 V, 50/60 Hz)	P-1000748	80
Franck-Hertz Tube with Hg	P-1003549	254 – 255
Franck-Hertz Tube with Mercury Filling and Heating Chamber (115 V, 50/60 Hz)	P-1006794	254 – 255
Franck-Hertz Tube with Mercury Filling and Heating Chamber (230 V, 50/60 Hz)	P-1006795	254 – 255
Franck-Hertz Tube with Ne	P-1003550	254 – 255
Franck-Hertz Tube with Ne Filling on Base	P-1000912	254 – 255
Franck-Hertz-Experiment	–	254 – 257
Free Electrons in Gases and in Vacuum	–	232 – 245
Free Fall Apparatus	P-1000738	67
Free Fall Tube	P-1000801	67
Free Standing Cylinder, without Graduation	P-1002871	302
Frequency Doubling Module	P-1008636	184 – 187
Fresnel Biprism	P-1008652	167
Fresnel Mirror Experiment Set	P-1003059	160
Fresnel Mirror K	P-1009927	150 – 151
Fresnel Mirror on Stem	P-1002649	160
Friction Measuring Apparatus	P-1009942	58
Friction Rods	P-1002709	194
Frosted Disc	P-1010031	161
Frosted Disc with "d"	P-1010030	161
Fuel Cell Demonstration System	P-1002689	120
Fuel Cell Experiment System	P-1013904	36

Description	Art. No.	Page
Fuel Cells	–	120
Function Generator 0.02 Hz – 2 MHz (230 V, 50/60 Hz)	P-1002744	274
Function Generator FG 100 (115 V, 50/60 Hz)	P-1009956	272
Function Generator FG 100 (230 V, 50/60 Hz)	P-1009957	272
Function Generator SG 10 (230 V, 50/60 Hz)	P-1017337	273
Function Generator SG 10 (115 V, 50/60 Hz)	P-1017338	273
Function Generators	–	272 – 274
Functional Model of the Eye	P-1005047	191
Fundamentals of Atomic Physics	–	252 – 253
Funhouse Mirror 135x210cm ²	P-1003338	190
Funhouse Mirror 60x130cm ²	P-1003339	190
Fuse Holder on 3B Box	P-1010154	200 – 201
Fuses, Set of	P-1012873	300
Fusion Ring	P-1000980	229
– G –		
Galvanometer, DC	P-1002790	278
Gas Discharge Tube	P-1002905	242
Gas Discharge Tube S	P-1000624	242
Gas Expansion Apparatus	P-1003511	132
Gas Filled Photocell	P-1000916	253
Gas Laws	–	137 – 140
Gas Triode D	P-1000653	234
Gas Triode S with He-Filling	P-1000618	239
Gas Triode S with Ne-Filling	P-1000619	239
GASTEC Gas Detector	P-1012504	37
Gauge with Adaptor	P-1012862	131
Gay-Lussac Pycnometer	P-1002874	84
Geared Motor with Pulley	P-1017735	31
Geiger Counter	P-1002722	29, 259
Geiger-Müller Counter Tube	P-1001035	259
Geiger-Müller Tube T	P-1000661	258c
Geometric Optics	–	149
Geometrical Objects on Glass Plate	P-1014622	161
Germanium Diode, AA 118, P2W19	P-1012963	207
Glass Cylinder with 2 Tubes	P-1002891	87
Glass Inset for Newton's Rings Experiments	P-1008669	160
Glass Shot, 100 g	P-1000834	301
Glassware	–	302
Globe with Bar Magnet	P-1013123	216
Glycerine, 250 ml	P-1007027	88, 301
Graduated Cylinder, 100 ml	P-1002870	301, 302
Graduated Cylinder, 250 ml	P-1010114	302
Graetz Bridge in 3B Box	P-1012695	200 – 201
Grating 1000/mm	P-1003181	163
Grating 140/mm	P-1003178	163
Grating 530/mm	P-1003179	163
Grating 600/mm	P-1003180	163
Gratings, Set of 4	P-1003081	163
Gravitation	–	56
Green LED on 3B Box	P-1010191	200 – 201
Greenhouse Effect	–	121
Gyroscope	P-1000695	74
Gyroscope	–	74
Gyroscope Accessories	P-1000698	74
Gyroscope S	P-1013228	74
– H –		
Hall Effect Basic Apparatus	P-1009934	264 – 265
Hall Effect	–	264 – 265
Hall Sensors	–	286
Halogen Lamp 12 V, 20 W	P-1003533	150 – 151
Halogen Lamp 500 W (230 V, 50/60 Hz)	P-1000894	120
Halogen Lamp, 12 V, 35 W	P-1003324	147
Halogen Lamp, 12 V, 55 W	P-1003322	146
Hand Spectroscope with Amici Prism	P-1003531	178
Hand-Held Analogue Measuring Instruments	–	278 – 279
Hand-Held Digital Measuring Instruments	–	280 – 283
HD Video Flex	P-1017789	292 – 293
Heart Model	P-1002590	115
Heat and Thermodynamics	–	124 – 145
Heat Conducting Rod Al	P-1017331	136
Heat Conducting Rod Cu	P-1017330	136
Heat Conduction	–	136
Heat Conduction Equipment Set	P-1017329	136
Heat Conductivity Device	P-1003383	133
Heat Equivalent Apparatus	P-1002658	128
Heat Flow	–	134 – 135
Heat Flow Device	P-1002903	133
Heat Flow Device S	P-1003512	133
Heat Pump D (115 V, 50/60 Hz)	P-1000819	144
Heat Pump D (230 V, 50/60 Hz)	P-1000820	144
Heat Sources	–	291
Heating Chamber (115 V, 50/60 Hz)	P-1006796	258
Heating Chamber (230 V, 50/60 Hz)	P-1012820	258
Heating rod K	P-1017340	104 – 105
Helical Spring Snakey	P-1008687	99
Helical Springs 1.5 N/m	P-1000786	53
Helical Springs 16 N/m	P-1002702	53
Helical Springs 2.5 N/m	P-1003515	53

Description	Art. No.	Page	Description	Art. No.	Page
Helical Springs 20 N/m, 180 mm	P-1002946	53	Infra-red Thermometer, 380° C	P-1008630	127
Helical Springs 3.0 N/m	P-1002945	53	Infra-red Thermometer, 800° C	P-1002791	127
Helical Springs 43 N/m	P-1002703	53	Insertion Thermometer	P-1003334	126
Helical Springs 5 N/m	P-1000741	53	Insertion Thermometer F	P-1010219	126
Helical Springs 86 N/m	P-1002704	53	Instrumentation	–	266 – 295
Helical Springs for Hooke's Law, Set of	P-1003376	53	Insulator with Clamp	P-1002970	199
Helmholtz Coils 300 mm	P-1000906	225, 244	Interference Filter 436 nm	P-1008671	165
Helmholtz Coils on Mounting Plate, Pair of	P-1003193	220	Interference Filter 546 nm	P-1008670	165
Helmholtz Pair of Coils D	P-1000644	236	Interference Filter 578 nm	P-1008672	165
Helmholtz Pair of Coils S	P-1000611	241	Interferometer	P-1002651	183
Helmholtz Resonator d = 32 mm	P-1003523	110	Interferometers	–	182 – 183
Helmholtz Resonator d = 40 mm	P-1003522	110	Inverting Spectacles	P-1000895	167
Helmholtz Resonator d = 52 mm	P-1003521	110	Ionisation Chamber	P-1000668	258h
Helmholtz Resonator d = 70 mm	P-1003520	110	IR Detector Card	P-1017879	184
He-Ne Laser	P-1003165	156	Iris Diaphragm K	P-1000850	150 – 151
Hexagonal Magnet Model	P-1002975	218	Iris on Stem	P-1003017	159
HF Coil, 33 mH, P2W19	P-1012984	207	Iron Filings	P-1000580	218
HF Patch Cord	P-1002746	301	Iron Plates, Set of 10	P-1002714	213
HF Patch Cord, BNC/4 mm Plug	P-1002748	301	Iron Wire 0.3 mm/ 100 m	P-1000950	198
Hg High-Pressure Spare Lamp (230 V, 50/60 Hz)	P-1003161	177	– J –		
Hg High-Pressure Spectral Lamp (230 V, 50/60 Hz)	P-1003157	177	Jet Nozzle (Flow Laminator)	P-1000758	94
Hg Low-Pressure Spare Lamp (230 V, 50/60 Hz)	P-1003162	177	Jolly's Bulb and Gauge	P-1012870	140
Hg Low-Pressure Spectral Lamp (230 V, 50/60 Hz)	P-1003158	177	Jumpers, P2W19, Set of 10	P-1012985	209
High Current Coil D for Nail Fusing Experiment	P-1000984	228	– K –		
High Current Coil S	P-1000999	229	Kater's Reversible Pendulum	P-1018466	77
High Current Coil with Five Turns	P-1000981	230	Kirchhoff-Bunsen Spectroscope	P-1002911	179
High Current Sensor, 10 A	P-1000545	43	Kit Greenhouse Effect (115 V, 50/60 Hz)	P-1009764	121
High Voltage Coil D Including 2 Horn Shaped Electrodes	P-1000991	228	Kit Greenhouse Effect (230 V, 50/60 Hz)	P-1000837	121
High Voltage Power Supply 5 kV (115 V, 50/60 Hz)	P-1003309	271	Knife-Edge Switch on 3B Box	P-1010152	200 – 201
High Voltage Power Supply 5 kV (230 V, 50/60 Hz)	P-1003310	271	Kolbe's Electrode	P-1001027	193
High-Pressure Mercury Vapour Lamp	P-1000852	177, 253	Kröncke Optical System for Student Exercises	–	32 – 33
High-Voltage Cables, 150 cm, Pair	P-1002851	300	Kröncke Optics	–	150 – 151
High-Voltage Power Supply E 5 kV (115 V, 50/60 Hz)	P-1017725	271	K-Type NiCr-Ni Immersion Sensor, -200°C – 1150°C	P-1002805	124 – 125
High-Voltage Power Supply E 5 kV (230 V, 50/60 Hz)	P-1013412	271	K-Type NiCr-Ni Immersion Sensor, -65°C – 550°C	P-1002804	124 – 125
Historical Experiments	–	303	Kundt's Tube	P-1000814	103
Hofmann's Voltmeter S	P-1003507	212	Kundt's Tube E	P-1017339	104 – 105
Hofmann's Voltmeter	P-1002899	212	– L –		
Holder for Components	P-1008524	198	Lab Material	–	296 – 302
Holder for Glassware	P-1010254	291	Laboratory Jack I	P-1002943	296
Holder for Hall Effect	P-1018753	265	Laboratory Jack II	P-1002941	296
Holder for Light Barrier	P-1018448	67	Laboratory Jack III	P-1002942	296
Holder for Magnetic Field Sensor	P-1019212	221	Laboratory Scales	–	288 – 289
Holder for Plug-in Components	P-1018449	298	Laminar Flow	–	95
Holder K for Diode Laser	P-1000868	150 – 151	Laminar Flow Apparatus	P-1006784	95
Holder on Stem for Direct-Vision Prism	P-1012863	159	Lamp Housing on a Stand Rod	P-1003197	176
Holder on Stem for Lenses without Frame	P-1003164	159	Lamp Socket E10 on Acrylic Base	P-1000946	198
Hole Diaphragms, Set of 5	P-1000848	161	Lamp Socket E14 on Acrylic Base	P-1000947	198
Hollow Prism, Equal-Sided	P-1014618	166	Lamp Sockets E10, Set of 10	P-1010137	199
Hologram	P-1003177	162	Laser Communication, Equipment Set	P-1003055	189
Hook Weights and Thread, Set of	P-1019180	63, 295	Laser Diode Driver and Temperature Controller	P-1008632	184 – 187
Horn Loudspeaker	P-1000811	111	Laser Diode for Debye-Sears Effect, Green	P-1002579	112
Horseshoe Magnet 130 mm, with Yoke	P-1003114	214	Laser Diode for Debye-Sears Effect, Red	P-1002577	112
Horseshoe Magnet 140 mm, with Yoke	P-1003088	214	Laser Diode, Red	P-1003201	156
Horseshoe Magnet, 70 mm	P-1000929	214	Laser Mirror	P-1008638	184 – 187
Human Pulse Sensor Box	P-1000575	44	Laser Mirror HAT, 532 nm	P-1008639	184 – 187
Humidity Sensor	P-1000554	43	Laser Module, Green	P-1003202	156
Hydraulic/Pneumatic Lifting Platform	P-1003495	86	Laser Ray Box (115, 50/60 Hz)	P-1003051	148
Hysteresis Curve, Equipment Kit	P-1018889	215	Laser Ray Box (230 V, 50/60Hz)	P-1003052	148
– I –			Laser Reflection Sensor	P-1001034	40,49
Ice Bomb	P-1000828	130	Laser Safety Goggles for Nd:YAG Laser	P-1002866	184
Image Objects, Set of 4	P-1000886	161	Launch Apparatus, Electromagnetic	P-1019300	62 – 63
Immersion Block Al 100 cm ³	P-1002953	84	Launcher S	P-1000740	69
Immersion Block Al 50 cm ³	P-1002952	84	Leclanché Cell	P-1002897	213
Immersion Block Fe 100 cm ³	P-1002955	84	LED Graetz Bridge in 3B Box	P-1012696	200 – 201
Immersion Block Fe 50 cm ³	P-1002954	84	LED Infra-red, Sideways Facing, P2W19	P-1018839	207
Immersion Heater (230 V, 50/60 Hz)	P-1003566	291	LED, Green, Upward Facing, P2W19	P-1012971	207
Immersion Heater, 12V	P-1003258	129	LED, Red, Sideways Facing, P2W19	P-1012972	207
Immersion/Circulation Thermostat (115 V, 50/60 Hz)	P-1008653	139	LED, Red, Upward Facing, P2W19	P-1012962	207
Immersion/Circulation Thermostat (230 V, 50/60 Hz)	P-1008654	139	LED, Yellow, Upward Facing, P2W19	P-1018837	207
Inclination Instrument E	P-1006799	217	Lenz's Law Copper Tube	P-1009716	227
Inclination Instrument	P-1003192	217	Lenz's Law Apparatus	P-1009959	227
Inclined Plane	P-1003213	60	Leslie Cube with Heater (115 V, 50/60Hz)	P-1017730	135
Indigo Solution	P-1000793	87, 301	Leslie Cube with Heater (230 V, 50/60Hz)	P-1017729	135
Inductance Decades	P-1013905	204	Leslie's Cube	P-1000835	134
Induction	–	224 – 227	Lever	P-1008539	60
Induction Apparatus	P-1000968	224	Light and Optics	–	146 – 191
Induction Coils, Set of 3	P-1000590	226	Light Box	P-1003209	35
Inertia Balance	P-1003235	77	Light Emitting Diodes for Determination of h	P-1000917	252
Infra-red Temperature and Humidity Gauge	P-1002795	122	Light Metal Tuning Fork, 1000 Hz	P-1002608	108
			Light Metal Tuning Fork, 1700 Hz	P-1002607	108
			Light Sensor	P-1000562	44
			Linear Expansion Apparatus D	P-1002977	131
			Linear Expansion Apparatus S	P-1002978	131
			Linear Expansion Apparatus with Three Pointers	P-1000830	131
			Linear Motion	–	61 – 63

Description	Art. No.	Page
Lip Whistle	P-1009924	110
Lodestone	P-1003091	215
Loop-Shaped Conductor on Acrylic Base	P-1000927	219
Lorentz Force Apparatus	P-1003251	222
Lorentz Motor	P-1002662	222 – 223
Low Temperature Stirling Engine Assembly Kit	P-1002599	143
Low Voltage Coil D	P-1000985	228
Low-Frequency Transformer, 1:2, P4W50	P-1012982	208
Low-Temperature Stirling Engine	P-1002598	143
Luminescence Tube D	P-1000648	233
Luminescence Tube S	P-1000615	238
– M –		
Mach-Zehnder-Interferometer	P-1014617	182
Magdeburg Hemispheres	P-1003208	90
Magdeburg Plates	P-1003496	90
Magic Mirror	P-1008686	303
Magnet Model, Cubic	P-1002976	218
Magnetic Equipment Set	P-1003089	214
Magnetic Field Indicator	P-1003555	216
Magnetic field line apparatus, Two-Dimensional	P-1003092	218
Magnetic Field Lines Device, Three-Dimensional	P-1009765	218
Magnetic Field Sensor ±100 mT	P-1000558	42
Magnetic Field Sensor ±2000 mT	P-1009941	42
Magnetic Field Sensor, Axial/Tangential	P-1001040	286
Magnetic Fields		216 – 221
Magnetic Fields, Set of Apparatus for Displaying	P-1000925	219
Magnetic Holder for Single-Ray Projector	P-1003323	147
Magnetic Needle, 80 mm	P-1000674	217
Magnetic Pucks, Pair	P-1003364	65
Magnetic Stirrer	P-1002808	290
Magnetic Stirrer 12L (230 V, 50/60 Hz)	P-1011739	290
Magnetic Stirrer with Heater (115 V, 50/60 Hz)	P-1002806	290
Magnetic Stirrer with Heater (230 V, 50/60 Hz)	P-1002807	290
Magnetic Stirrers		290
Magnetism		214 – 223
Magnetising Coil	P-1003237	220
Magnets		214
Mains Coil D with Connecting Lead (115 V, 50/60 Hz)	P-1000986	228
Mains Coil D with Connecting Lead (230 V, 50/60 Hz)	P-1000987	228
Maltese Cross Tube D	P-1000649	233
Maltese Cross Tube S	P-1000011	238
Marble in a Bowl	P-1017332	71
Mariotte Flask	P-1002894	140
Maximum Minimum Thermometer	P-1011450	122
Maxwell's Wheel	P-1000790	70
Measurement Amplifier (115 V, 50/60 Hz)	P-1001021	287
Measurement Amplifier (230 V, 50/60 Hz)	P-1001022	287
Measurement of Length		50
Measurement of Time		49
Measurement of Volume		51
Measuring Amplifier S	P-1001028	287
Mechanical Balance 311	P-1003421	288
Mechanical Balance 610	P-1003419	288
Mechanical Cumulative Stopwatch	P-1002810	49
Mechanical Stopwatch, 15 min	P-1003369	49
Mechanical Stopwatch, 30 min	P-1003368	49
Mechanical Waves		99 – 102
Mechanics		48 – 95
Mechanics Kit for Whiteboard	P-1000735	48
Mechanics on a Whiteboard		48
Metal Bridge	P-1018835	83
Metal Ring	P-1000992	229
Metal Strips, Set of 5	P-1000982	229
Metallophone	P-1000804	110
Michelson Interferometer		183
Micrometer Screw K	P-1000887	150 – 151
Micromotor, 1.5 V DC, P2W19	P-1012995	207
Microphone	P-1000565	41
Microphone Probe, long	P-1017342	104 – 105
Microphone Probe, short	P-4008308	104 – 105
Microscopes		294
Microsecond counter (115 V, 50/60 Hz)	P-1017334	106
Microsecond Counter (230 V, 50/60 Hz)	P-1017333	106
Microstructures on Glass Plate	P-1014620	164
Microvoltmeter (115 V, 50/60 Hz)	P-1001015	287
Microvoltmeter (230 V, 50/60 Hz)	P-1001016	287
Microwave Set 10.5 GHz (115 V, 50/60 Hz)	P-1009950	96 – 97
Microwave Set 9.4 GHz (230 V, 50/60 Hz)	P-1009951	96 – 97
Millikan's Apparatus (115 V, 50/60 Hz)	P-1019213	251
Millikan's Apparatus (230 V, 50/60 Hz)	P-1019214	251
Millikan's Experiment		251
Millikan's Oil Drop Experiment		251
Millisecond Counter (115 V, 50/60 Hz)	P-1012833	285
Millisecond Counter (230 V, 50/60 Hz)	P-1012832	285
Model Crystals		248
Model Eye for Ultrasonic Biometry	P-1012869	116

Description	Art. No.	Page
Model of a Human Eye, 6-Piece	P-1000259	191
Molecule Building Sets		249
Moll-Type Thermopile	P-1000824	121, 134
Momentary Contact Switch on Acrylic Base	P-1000962	198
Monochord	P-1000806	110
Monochord D	P-1002959	110
Monochord Strings, Set of 3	P-1002960	110
Monocular Course Microscope Model 100 (230 V, 50/60 Hz)	P-1005402	294
MoS ₂ Sample	P-1012877	247
Motion in a Plane		64 – 66
Motor Drive Debye-Scherrer (230 V, 50/60 Hz)	P-1019216	258b
Motor with Drive Control	P-1002705	170
Motor, 12 V DC	P-1001041	101
Multimeter		278 – 283
Multiple Ray Projector, Magnetic	P-1003321	146
Multiple Slits on Glass Plate	P-1008666	164
– N –		
Na Low-Pressure Spare Lamp (230 V, 50/60 Hz)	P-1003163	177
Na Low-Pressure Spectral Lamp (230 V, 50/60 Hz)	P-1003159	177
Nal Operating and Evaluation Unit	P-1008708	261
Nal(Tl) Scintillation Detector	P-1008707	261
Nails for Nail Fusing Experiment, Set of 20	P-1000983	229
Nd:YAG Module	P-1008635	184 – 187
N-Doped Germanium on Printed Circuit Board	P-1009760	264 – 265
NEVA Optical System		152
Newton's Colour Disc	P-1002983	170
Newton's Colour Disc, with Crank	P-1010194	170
Newton's Colour Disc, with DC Motor	P-1010175	170
Nickel Plates, Set of 5	P-1002715	213
Nickel Wire 0.3 mm / 50 m	P-1000951	198
NMR		262 – 263
NMR Supplementary Set	P-1000642	262 – 263
Noise		123
Noise Level Indicator SPL	P-1012741	123
Noise Level Meter P8005	P-1002780	283
NPN Transistor BC140, P4W50	P-1018845	208
NPN Transistor, BC 550, P4W50	P-1012976	208
NPN Transistor, BD 137, P4W50	P-1012974	208
NTC Resistor, 2.2 kΩ, P2W19	P-1012941	207
– O –		
Object for Measurement Exercises	P-1006889	51
Object Holder N	P-1000845	152
Object Holder on Stem	P-1000855	158
Objective for Beam Divergence	P-1000675	156
Oersted's Needle Device	P-1009710	215
Ohm's Law Apparatus in 3B Box	P-1012698	200 – 201
Oil for Millikan Apparatus, 50ml	P-1013318	251
Oil for Steam Engine	P-1012887	145
Operating Unit for Fine-Beam Tube	P-1009948	245
Operational Amplifier, LM 741, P4W50	P-1012981	208
Optical Apertures		161 – 165
Optical Base D	P-1009733	155
Optical Bench K, 1000 mm	P-1009696	150 – 151
Optical Bench K, 2000 mm	P-1009699	150 – 151
Optical Bench K, 500 mm	P-1009926	150 – 151
Optical Bench KL	P-1008642	184 – 187
Optical Bench N	P-4003987	152
Optical Bench U, 1200 mm	P-1003039	153
Optical Bench U, 600 mm	P-1003040	153
Optical Components on Stem		157 – 159
Optical Components, Set	P-1002993	149
Optical Crystals		166 – 167
Optical Diffraction Elements		162 – 164
Optical Disc with Accessories	P-1003036	153
Optical Disc with Diode Laser (115 V, 50/60 Hz)	P-1003057	149
Optical Disc with Diode Laser (230 V, 50/60 Hz)	P-1003058	149
Optical Equivalent to Debye-Scherrer Interference	P-1000656	236
Optical Filters		165
Optical Lamp K	P-1000863	150 – 151
Optical Lamp N (115 V, 50/60 Hz)	P-1009945	152
Optical Lamp N (230 V, 50/60 Hz)	P-1009946	152
Optical Lamp with Pinhole Aperture	P-1017284	182
Optical Lamp, Halogen	P-1003188	155
Optical Lamps on Stem		156
Optical Precision Bench D, 100 cm	P-1002628	154
Optical Precision Bench D, 200 cm	P-1002629	154
Optical Precision Bench D, 50 cm	P-1002630	154
Optical Rider D, 120/36	P-1012402	154
Optical Rider D, 120/50	P-1002637	154
Optical Rider D, 60/36	P-1002639	154
Optical Rider D, 60/50	P-1012400	154
Optical Rider D, 90/36	P-1012401	154
Optical Rider D, 90/50	P-1002635	154
Optical Rider K	P-1000862	150 – 151
Optical Rider U, 35 mm	P-1003042	153

Description	Art. No.	Page	Description	Art. No.	Page
Optical Rider U, 75 mm	P-1003041	153	Plano Convex Lens, $f = +400$ mm	P-1002987	146
Optical Telecommunications	–	188	Plastic Trough	P-4000036	132, 302
Optical Telecommunications Equipment Set	P-1008674	188	Plate Capacitor D	P-1006798	197
Optics Kit for Whiteboard	P-1000604	146	Plate Capacitor S	P-1003232	197
Optics on a Whiteboard	–	146 – 148	Plate for Metal Filings	P-1010256	291
Optics Using an Optical Bench D	–	154 – 155	Platinum-Iridium Wire	P-1012878	247
Optics Using an Optical Bench U	–	153	Plotter Paper, Set	P-1003361	65
Optics with Laser Ray Box, Equipment Set	P-1003049	148	Plug In Power Supply 24 V, 0.7 A (115V, 50/60 Hz)	P-1000680	81, 266
Orbit™ Tellurium	P-1008661	56	Plug In Power Supply 24 V, 0.7 A (230 V, 50/60 Hz)	P-1000681	81, 266
Organic Molecule Set D	P-1005278	248 – 249	Plug-In Board for Components	P-1012902	206
Organic Molecule Set S	P-1005290	248 – 249	Plug-In Component System	–	206 – 209
Organic/Inorganic Molecule Set D	P-1005279	248 – 249	Plug-In Power Supply 3 V DC (100-240 V, 50/60 Hz)	P-1008659	160
Organic/Inorganic Molecule Set S	P-1005291	248 – 249	Plug-In Power Supply, 12 V AC, 2000 mA (115 V, 50/60 Hz)	P-1012899	266
Oscillation Tube	P-1002895	140	Plug-In Power Supply, 12 V AC, 2000 mA (230 V, 50/60 Hz)	P-1012900	266
Oscillations	–	75 – 82	Plug-In Power Supply, 12 V AC, 500 mA (115 V, 50/60 Hz)	P-1009545	266
Oscilloscope Probe, 100 MHz	P-1002777	274	Plug-In Power Supply, 12 V AC, 700 mA (230 V, 50/60 Hz)	P-1001014	266
Oscilloscopes	–	275 – 277	Plumb with Line	P-1002940	57
Outlet Vessel, Metal	P-1009715	87	Pneumatic Lighter	P-1003569	140
– P –			PNP Transistor BC160, P4W50	P-1018846	208
Pair of Adaptor Cables 4-mm/2-mm Plug	P-1017899	128	PNP Transistor, BC 560, P4W50	P-1012977	208
Pair of Bar Magnets, 80 mm	P-1003085	214	PNP Transistor, BD 138, P4W50	P-1012975	208
Pair of Bar Magnets, AlNiCo, 60 mm, with Two Iron Yokes	P-1003086	214	Pockels Cell on Stem	P-1013393	173
Pair of Capacitor Plates 125 cm ²	P-1000934	197	Pockels Effect	–	173
Pair of Capacitor Plates 250 cm ²	P-1000933	197	Pocket Measuring Tape, 2 m	P-1002603	50
Pair of Capacitor Plates 500 cm ²	P-1000932	197	Pocket Spectroscope	P-1003078	178
Pair of Clamps D	P-1000977	230	Pocket Thermometer -10 – 110°C	P-1002881	124 – 125
Pair of Elastic Balls with Plotting Electrode	P-1000779	66	Pohl's Torsion Pendulum	P-1002956	81
Pair of Experiment Leads, 75 cm	P-1002850	299	Polarimeter	P-1008696	175
Pair of Flat Coils	P-1000942	218	Polarimeter Tube 100 mm	P-1012883	175
Pair of Helmholtz Coils on Mounting Plate	P-1003193	220	Polarimeter Tube 200 mm	P-1012884	175
Pair of High-Voltage Cables, 150 cm	P-1002851	300	Polarimeter with 4 LEDs (115 V, 50/60 Hz)	P-1001056	174
Pair of Magnetic Pucks	P-1003364	65	Polarimeter with 4 LEDs (230 V, 50/60 Hz)	P-1001057	174
Pair of Polarsation Filters K	P-1009929	150 – 151	Polarisation	–	174 – 175
Pair of Pole Shoes and Clamping Brackets D for Hall Effect	P-1009935	230	Polarisation Filter (Glass)	P-1003328	162
Pair of Pole Shoes D	P-1000978	230	Polarisation Filter on Stem	P-1008668	158
Pair of Rail Supports	P-1003044	153	Polarisation Filters K, Pair	P-1009929	150 – 151
Pair of Reflection Blocks with Delay Path	P-1002587	114	Pole Shoe Fitting D	P-1008525	230
Pair of Safety Experiment Leads, 75 cm, Black	P-1002849	300	Pole Shoes and Clamping Brackets for Hall Effect, Pair	P-1009935	230
Pair of Safety Experiment Leads, 75cm, Red	P-1017716	300	Pole Shoes D, Pair	P-1000978	230
Pair of Safety Experiment Leads, 75cm, Red/Blue	P-1017718	300	Polyoxymethylene Test Block with Protractor Scale	P-1002586	114
Pair of Tuning Forks, 440 Hz, on Resonance Boxes	P-1002612	109	p-Orbitals, Set of 3	P-1012841	250
Pair of Tuning Weights	P-1002611	109	Potentiometer 1 k Ω , 1 W, P4W50	P-1012936	208
Paraffin Prism	P-4008112	97	Potentiometer 10 k Ω , 1 W, P4W50	P-1012937	208
Parallel Light Optical Lamp N (115 V, 50/60 Hz)	P-1006790	152	Potentiometer 100 k Ω , 1 W, P4W50	P-1012939	208
Parallel Light Optical Lamp N (230 V, 50/60 Hz)	P-1006791	152	Potentiometer 220 Ω , 3 W, P4W50	P-1012934	208
Pascal's Pressure Sphere	P-1002892	86	Potentiometer 4.7 k Ω , 1 W, P4W50	P-1012938	208
Pascal's Vane Apparatus	P-1002957	86	Potentiometer 470 Ω , 1 W, P4W50	P-1012935	208
P-Doped Germanium on Printed Circuit Board	P-1009810	264 – 265	Powder Tracing, Equipment Set	P-1000739	66
Pendulum Bobs, Set of 4	P-1003230	75	Power Function Generator (115 V, 50/60 Hz)	P-1001036	272
Pendulum Rod	P-1000764	75	Power Function Generator (230 V, 50/60 Hz)	P-1001037	272
Pendulum Rod with Angle Sensor (115 V, 50/60 Hz)	P-1000762	75	Power Supplies	–	266 – 271
Pendulum Rod with Angle Sensor (230 V, 50/60 Hz)	P-1000763	75	Power Supply Unit for Franck-Hertz Experiment (115 V, 50/60 Hz)	P-1012818	254 – 257
Pendulum with Plotting Electrode	P-1000780	66	Power Supply Unit for Franck-Hertz Experiment (230 V, 50/60 Hz)	P-1012819	254 – 257
Periodic Table of the Elements	–	246	Precision Dynamometer 0.1 N	P-1003102	52
Periodic Table of the Elements, with Electron Configurations	P-1017655	246	Precision Dynamometer 0.2 N	P-1003103	52
Periodic Table of the Elements, with Pictures	P-1013907	246	Precision Dynamometer 1 N	P-1003104	53, 58
Permanent Magnet with Adjustable Pole Spacing	P-1002660	222 – 223	Precision Dynamometer 10 N	P-1003107	53, 58
Perrin Tube D	P-1000650	233	Precision Dynamometer 100 N	P-1003110	52
Perrin Tube S	P-1000616	238	Precision Dynamometer 2 N	P-1003105	53, 58
pH Combined Electrode	P-1002720	211	Precision Dynamometer 20 N	P-1003108	52
pH Sensor	P-1000556	45	Precision Dynamometer 5 N	P-1003106	52
Photo Gate	P-1000563	40, 49	Precision Hair Hygrometer	P-1002877	122
Photo Gate Holder for Projectile Launcher	P-1002657	69	Precision Resistor 1 k Ω	P-1009887	202
Photogate Holder for Pendulum	P-1000756	76	Precision Resistor 1 M Ω	P-1000687	202
Photoresistor, LDR 05, P2W19	P-1012940	207	Precision Resistor 1 Ω	P-1009843	202
Phototransistor BPX43, P2W19	P-1018842	207	Precision Resistor 10 k Ω	P-1000685	202
Photovoltaics	–	30 – 31	Precision Resistor 10 M Ω	P-1000688	202
Physical Eye Model	P-1003806	191	Precision Resistor 10 Ω	P-1009844	202
Picket Fence	P-1000564	40	Precision Resistor 100 k Ω	P-1000686	202
Piezoelectric Charge Source	P-1000923	193	Precision Resistor 100 Ω	P-1009886	202
PIN Photodiode DET 10 A/M	P-1008641	184 – 187	Precision Resistor 300 k Ω	P-1000690	202
PIN Photodiode DET 36 A/M	P-1008640	184 – 187	Precision Sphereometer	P-1002947	50
Pirani Vacuum Gauge (230 V, 50/60 Hz)	P-1012514	93	Pressure	–	86
Piston Vacuum Pump	P-1000798	92	Pressure Balance	P-1002653	86
Planck's Constant Apparatus (115 V, 50/60 Hz)	P-1000536	252	Pressure Container for Determining Weight of Air	P-1000796	85
Planck's Constant Apparatus (230 V, 50/60 Hz)	P-1000537	252	Pressure Sensor, ± 100 hPa, Relative	P-1000547	43
Plane Mirror	P-1002984	146	Pressure Sensor, ± 1000 hPa, Relative	P-1000548	43
Plane Mirror	P-1003190	302	Pressure Sensor, 2500 hPa, Absolute	P-1000546	43
Plane Mirror K	P-1003532	150 – 151	Prism Table K	P-1000876	150 – 151
Plane Mirror on Stem	P-1003033	157			
Plane Parallel Plate	P-1002988	146			
Plano Concave Lens, $f = -400$ mm	P-1002986	146			

Description	Art. No.	Page
Prism Table on Stem	P-1003019	159
Prisms	–	166 – 167
Prisms, Set of 3	P-1002863	166
Probe Microphone @230	P-1014520	106
Probe Microphone (115 V, 50/60 Hz)	P-1014521	106
Projectile Launcher	P-1002654	68
Projection Screen	P-1000608	159
Projection Screen K, Transparent	P-1000878	150 – 151
Projection Screen K, White	P-1000879	150 – 151
Projection Screen N	P-1012891	152
Protective Adaptor, 2-Pole	P-1009961	236
Protective Adaptor, 3-Pole	P-1009960	236
Psycho-Acoustics	–	107
PTC Resistor, 100 Ω, P2W19	P-1012942	207
Puck Guide	P-1003359	65
Pulley Block with 1 Pulley	P-1003216	60
Pulley Block with 2 Pulleys	P-1003217	60
Pulley Block with 3 Pulleys	P-1003218	60
Pulley with Table Clamp	P-1003221	60
Pulleys and Block and Tackle, Experiment Set	P-1003224	59
Pulse box K	P-1017341	106
Push Button Switch (NC) Sing. Pole P2W19	P-1012989	207
Push Button Switch (NO) Sing. Pole P2W19	P-1012988	207
Pythagorean Cup	P-1002904	303
– Q –		
Quincke's Resonance Tube	P-1018475	103
Quinhydrone Buffer Solution	P-1002754	45
– R –		
Radiation Cartridge, 226Ra, 4 kBq	P-1006797	29, 260
Radiation of Heat	–	133
Radioactivity	–	259 – 261
Radiography Accessories	P-1000667	258b
Rail Supports, Pair	P-1003044	153
Recording Tuning Fork, c 128 Hz	P-1002606	108
Red LED on 3B Box	P-1010190	200 – 201
Redox Sensor	P-1000555	46
Reed Pipe	P-1012893	110
Reflection Blocks with Delay Path, Pair of	P-1002587	114
Reflection Grating	P-1003083	162
Regenerative Energies	–	36
Relative Pressure Sensor, ±100 hPa	P-1000547	43
Relative Pressure Sensor, ±1000 hPa	P-1000548	43
Relay	P-1000566	46
Relay with Change-Over Contact, P4W50	P-1012992	208
Replacement Circuit Board for Tube Holder S	P-4008573	241
Resistance Apparatus	P-1009949	202
Resistance Bridge	P-1009885	202
Resistance Decade 1 kΩ	P-1002733	203
Resistance Decade 1 Ω	P-1002730	203
Resistance Decade 10 kΩ	P-1002734	203
Resistance Decade 10 Ω	P-1002731	203
Resistance Decade 100 Ω	P-1002732	203
Resistance Decade, 1 Ω – 10 kΩ	P-1002735	203
Resistor 1 kΩ, 2 W, P2W19	P-1012916	206
Resistor 1 MΩ, 0.5 W, P2W19	P-1012932	206
Resistor 1 Ω, 2 W, P2W19	P-1012903	206
Resistor 1.5 kΩ, 2 W, P2W19	P-1012917	206
Resistor 10 kΩ, 0.5 W, P2W19	P-1012922	206
Resistor 10 MΩ, 0.5 W, P2W19	P-1012933	206
Resistor 10 Ω, 10 W, P2W19	P-1012905	206
Resistor 10 Ω, 2 W, P2W19	P-1012904	206
Resistor 100 kΩ, 0.5 W, P2W19	P-1012928	206
Resistor 100 Ω, 2 W, P2W19	P-1012910	206
Resistor 15 kΩ, 0.5 W, P2W19	P-1012923	206
Resistor 150 Ω, 2 W, P2W19	P-1012911	206
Resistor 2.2 kΩ, 2 W, P2W19	P-1012918	206
Resistor 22 kΩ, 0.5 W, P2W19	P-1012924	206
Resistor 22 Ω, 2 W, P2W19	P-1012907	206
Resistor 220 kΩ, 0.5 W, P2W19	P-1012929	206
Resistor 220 Ω, 2 W, P2W19	P-1012912	206
Resistor 3.3 kΩ, 2 W, P2W19	P-1012919	206
Resistor 33 kΩ, 0.5 W, P2W19	P-1012925	206
Resistor 330 kΩ, 0.5 W, P2W19	P-1012930	206
Resistor 330 Ω, 2 W, P2W19	P-1012913	206
Resistor 4.7 kΩ, 2 W, P2W19	P-1012920	206
Resistor 47 kΩ, 0.5 W, P2W19	P-1012926	206
Resistor 47 Ω, 2 W, P2W19	P-1012908	206
Resistor 470 kΩ, 0.5 W, P2W19	P-1012931	206
Resistor 470 Ω, 2 W, P2W19	P-1012914	206
Resistor 5, 1 Ω, 2 W, P2W19	P-1012906	206
Resistor 6.8 kΩ, 2 W, P2W19	P-1012921	206
Resistor 68 kΩ, 0.5 W, P2W19	P-1012927	206
Resistor 68 Ω, 2 W, P2W19	P-1012909	206
Resistor 680 Ω, 2 W, P2W19	P-1012915	206
Resonance Bowl	P-1003206	303
Resonance Wire, Ring Shaped	P-1000707	100
Rheostat 1 Ω	P-1003062	203
Rheostat 10 Ω	P-1003064	203
Rheostat 100 Ω	P-1003066	203

Description	Art. No.	Page
Rheostat 1000 Ω	P-1003068	203
Rheostat 3.3 Ω	P-1003063	203
Rheostat 33 Ω	P-1003065	203
Rheostat 330 Ω	P-1003067	203
Rheostat 3300 Ω	P-1003069	203
Riders for Rulers, Set	P-1006494	50
Right Angled Prism	P-1002990	146
Ripple Tank PM02	P-1017591	98
Riser Tubes for Pressure Measurement	P-1002573	118
Rocker Switch, Single Pole, P2W19	P-1012990	207
Rod Clamp with Insulator	P-1001054	199
Rod Thermometer -10 – 100°C	P-1003526	124 – 125
Rotary Vane Vacuum Pump PK 4 D (230 V, 50/60 Hz)	P-1002919	93
Rotary-Vane Vacuum Pump, One-Stage	P-1012855	92
Rotary-Vane Vacuum Pump, Two-Stage	P-1003317	92
Rotating Base for Leslie cube	P-1017875	134
Rotating Object Holder on Stem	P-1003016	158
Rotating System on Air Bed (115 V, 50/60 Hz)	P-1000781	72
Rotating System on Air Bed (230 V, 50/60 Hz)	P-1000782	72
Rotation Apparatus	P-1006785	73
Rotational Motion	–	72 – 73
Round Cell, 100 mm	P-1002884	175
Round Cell, 200 mm	P-1002885	175
Round-Bottomed Flask, 250 ml	P-1011768	302
Round-Bottomed Flask, 500 ml	P-1011769	302
Rowland Grating	P-1002917	162
Rubber Band	P-1000702	100
Rubber Belt for Van de Graaff Generator	P-1002965	192
Ruled Gratings	P-1000600	163
Ruler, 1 m	P-1000742	50
– S –		
Safety Crocodile Clips 4 mm, Set of 6	P-1019218	300
Safety Experiment Leads for Free Fall Apparatus, Set of 3	P-1002848	300
Safety Experiment Leads, 75 cm, Black, Pair of	P-1002849	300
Safety Experiment Leads, 75 cm, Red, Pair of	P-1017716	300
Safety Experiment Leads, 75 cm, Red/Blue, Pair of	P-1017718	300
Safety Experiment Leads, 75 cm, Set of 15	P-1002843	300
Safety Experiment Leads, 75 cm, Set of 3	P-1017719	300
Scanning Tunnelling Microscope	P-1012782	247
Seals, Set of	P-1002672	139
SEK Base Plate	P-1000789	17
SEK Electricity and Magnetism	P-1008532	20 – 21
SEK Heat	P-1008528	18 – 19
SEK Mechanical Oscillations and Waves (115 V, 50/60 Hz)	P-1018476	24 – 25
SEK Mechanical Oscillations and Waves (230 V, 50/60 Hz)	P-1016652	24 – 25
SEK Mechanics	P-1008527	16
SEK Optics (115 V, 50/60 Hz)	P-1008530	22 – 23
SEK Optics (230 V, 50/60 Hz)	P-1008531	22 – 23
SEK Power Supply (115 V, 50/60 Hz)	P-1000997	21
SEK Power Supply (230 V, 50/60 Hz)	P-1000998	21
SEK Radioactivity	P-1006804	28 – 29
SEK Solar Energy (115 V, 50/60 Hz)	P-1017731	30 – 31
SEK Solar Energy (230 V, 50/60 Hz)	P-1017732	30 – 31
SEK Ultrasonic Waves (115 V, 50/60 Hz)	P-1014529	26 – 27
SEK Ultrasonic Waves (230 V, 50/60 Hz)	P-1016651	26 – 27
Semi Circular Body, f = +200 mm	P-1002989	146
Semicircular Cell	P-1003191	149
Sensor Holder for Stirling Engine G	P-1008500	141
Sensors	–	40 – 47
Set 10 Crocodile Clips 4mm, Not Insulated	P-1019219	299
Set 14 Bravais Lattices	P-1012837	248 – 249
Set of 3 Safety Experimental Leads, 75cm	P-1017719	300
Set of "Conductors and Non-Conductors"	P-1000948	199
Set of 10 Aluminium Plates	P-1002716	213
Set of 10 Beakers, Low Form	P-1002872	302
Set of 10 Beakers, Tall Form	P-1002873	302
Set of 10 Cast Iron Bolts	P-1000827	130
Set of 10 CO ₂ Test Tubes, 0.03 – 1.00% by vol.	P-1012524	37
Set of 10 CO ₂ Test Tubes, 0.5 – 8.0% by vol.	P-1012526	37
Set of 10 Copper Plates	P-1002712	213
Set of 10 E10 Bulbs 12 V, 100 mA	P-1010140	199
Set of 10 E10 Bulbs 12 V, 500 mA	P-1010141	199
Set of 10 E10 Bulbs 3.5 V, 150 mA	P-1010142	199
Set of 10 E10 Bulbs 3.5 V, 200 mA	P-1010143	199
Set of 10 E10 Bulbs 6 V, 100 mA	P-1010145	199
Set of 10 E10 Bulbs 6 V, 350 mA	P-1010144	199
Set of 10 E10 Bulbs, 1.3 V, 60 mA	P-1010199	199
Set of 10 E10 Bulbs, 3.8 V, 300 mA	P-1010195	199
Set of 10 E10 Bulbs, 4 V, 40 mA	P-1010196	199
Set of 10 E10 Bulbs, 6 V, 1 A	P-1010198	199
Set of 10 E10 Bulbs, 6 V, 50 mA	P-1010197	199
Set of 10 E10 Lamp Sockets	P-1010137	199
Set of 10 Iron Plates	P-1002714	213
Set of 10 Jumpers, P2W19	P-1012985	209
Set of 10 O ₂ Test Tubes, 6 – 24% by vol.	P-1012527	37

Description	Art. No.	Page	Description	Art. No.	Page
Set of 10 Pairs of Protective Rubber Stoppers	P-1012528	37	Set of Weights 1 g to 500 g	P-1010189	55
Set of 10 Tracing Compasses	P-1003095	217	Set of Weights 1 g to 500 g, slotted with Holder	P-1018597	54
Set of 10 Watch Glass Dishes, 120 mm	P-1002869	302	Set of Weights 1 mg to 500 mg	P-1010234	55
Set of 10 Watch Glass Dishes, 80 mm	P-1002868	302	Set of Weights 10 g to 1000 g	P-1003214	54
Set of 10 Weights, 10 g	P-1000770	54	Set of Weights 100 g to 2000 g	P-1001052	54
Set of 10 Weights, 20 g	P-1000769	54	Set of Weights with Hooks	P-1010168	55
Set of 10 Weights, 50 g	P-1000771	54	Shadow Casting Bodies	P-1002992	146
Set of 10 Wooden Rulers, 0.5 m	P-1003234	51	Shaker	P-1000581	218
Set of 10 Wooden Rulers, 1 m	P-1003233	51	Shear Modulus	–	89
Set of 10 Zinc Plates	P-1002713	213	Silicon Diode, 1N 4007, P2W19	P-1012964	207
Set of 100 Balloons	P-1010125	90	Silicon Diode, BY 255, P2W19	P-1012961	207
Set of 100 Cuvette Cells, 4 ml	P-1018106	181	Silicon photocell BPY47P, P2W19	P-1018844	207
Set of 12 Materials with 4 Different Masses each	P-1003500	85	Simple Machines	–	59 – 60
Set of 15 Bodies with 2 Different Densities	P-1003501	85	Sine Wave Generator	P-1001038	273
Set of 15 Experiment Leads, 75 cm 1 mm ²	P-1002840	299	Single Breast Model with Benign Tumor	P-1000345	116
Set of 15 Experiment Leads, 75 cm 2.5 mm ²	P-1002841	299	Single Ray Projector	P-1000682	147
Set of 15 Safety Experiment Leads, 75 cm	P-1002843	300	Single Slit N	P-4004002	152
Set of 1-Litre Bodies	P-1012882	51	Single Slits, Set of 5	P-1000846	162
Set of 2 Materials with 4 Different Masses each	P-1003499	85	Single-Throw Switch on Acrylic Base	P-1000961	198
Set of 20 Nails for Nail Fusing Experiment	P-1000983	229	Skin Resistance Box	P-1000576	44
Set of 3 Areometers	P-1003012	84	Sliding Rider D	P-1002644	154
Set of 3 Carbon Configurations	P-1012836	248 – 249	Slit and Hole Diaphragms, Set of 5	P-1000607	161
Set of 3 Colour Filters, Primary Colours	P-1003185	165	Slits and Bars on Glass Plate	P-1008665	164
Set of 3 Colour Filters, Secondary Colours	P-1003186	165	Slotted Weights, 10 x 10 g, Red and Grey, Set of	P-1000773	54
Set of 3 Conductivity Standards	P-1000552	45	Slotted Weights, 10 x 10 g, Set of	P-1003227	54
Set of 3 Cylinders	P-1002588	115	Slotted Weights, 20 – 100 g, Set of	P-1003226	54
Set of 3 Cylinders, Equal in Mass	P-1000754	84	Slotted Weights, 4 x 100 g, Red and Grey, Set of	P-1000777	54
Set of 3 Cylinders, Equal in Volume	P-1000752	84	Slotted Weights, 5 x 100 g, Set of	P-1003229	54
Set of 3 Induction Coils	P-1000590	226	Slotted Weights, 5 x 50 g, Set of	P-1003228	54
Set of 3 Monochord Strings	P-1002960	110	Slotted Weights, 8 x 50 g, Red and Grey, Set of	P-1000775	54
Set of 3 p-Orbitals	P-1012841	250	Sodium Fluorescence Tube on Furnace Wall	P-1000913	258
Set of 3 Prisms	P-1002863	166	Soft Iron Bars	P-1003090	215
Set of 3 Safety Experiment Leads for Free Fall Apparatus	P-1002848	300	Software for Fourier Analysis	P-1012587	47
Set of 3 Steel Balls	P-4003748	67	Solar Energy	–	30, 120
Set of 3 Thermocouples	P-1017904	295	Solar Energy Basic Kit	P-1000839	120
Set of 3 Weight Holders with Slotted Weights	P-1000676	55	Solid-State Laser Physics	–	184 – 187
Set of 30 Electrodes for ECG/EMG	P-5006578	44	s-Orbital	P-1012842	250
Set of 4 Calorimeter Cylinders	P-1003253	129	Sound	–	103 – 110
Set of 4 Gratings	P-1003081	163	Sound Level Meter P5055	P-1002778	283
Set of 4 Image Objects	P-1000886	161	Sound Propagation in Solid Bodies	–	107
Set of 4 Pendulum Bobs	P-1003230	75	Spare Bulb for Stroboscope	P-1003332	285
Set of 5 Carbon Plates	P-1002717	213	Spare Bulbs for Halogen Lamp (230 V, 50/60 Hz)	P-1003536	120
Set of 5 Density Bodies	P-1000768	83	Spare Halogen Lamp, 12 V, 50 W	P-1002837	155
Set of 5 d-Orbitals	P-1012840	250	Spare Lamp for Light Box	P-1003231	35
Set of 5 Hole Diaphragms	P-1000848	161	Spare Sodium Lamp	P-1012885	175
Set of 5 Metal Strips	P-1000982	229	Spare Tube for Pneumatic Lighter	P-1003570	140
Set of 5 Nickel Plates	P-1002715	213	Spare Tube for X-Ray Apparatus	P-1000664	258a
Set of 5 Single Slits	P-1000846	162	Special Carbon Paper, Set	P-1003366	65
Set of 5 Slit and Hole Diaphragms	P-1000607	161	Spectral Lamp Cd	P-1003537	176
Set of 6 Safety Crocodile Clips 4 mm	P-1019218	300	Spectral Lamp He	P-1003539	176
Set of 6 Steel Balls	P-1002939	68	Spectral Lamp Hg 100	P-1003545	176
Set of 60 Ecoflam Pellets	P-1010255	291	Spectral Lamp Hg/Cd	P-1003546	176
Set of 7 Colour Filters	P-1003084	165	Spectral Lamp Na	P-1003541	176
Set of 7 Cubes for Determining Density	P-1000766	85	Spectral Lamp Ne	P-1003543	176
Set of 7 f-Orbitals	P-1012838	250	Spectral Lamp Ti	P-1003544	176
Set of Apparatus for Displaying Magnetic Fields	P-1000925	219	Spectrometer-Goniometer	P-1002912	179
Set of Bodies for Air Resistance and Buoyancy Experiments	P-1000760	94	Spectrometer-Goniometer S	P-1008673	179
Set of Components for Electronics Experiments	P-1018532	209	Spectrometers	–	178 – 181
Set of Doppler Prisms and Flow Tubes	P-1002572	118	Spectrometry Supplementary Set	P-1008675	188
Set of Drawing Instruments for Whiteboard	P-1002593	295	Spectrophotometer S	P-1003061	181
Set of Experiment Leads for Electron Tube Experiments	P-1002847	299	Spectroscope in Cardboard Case	P-1003183	178
Set of Fluorescence Samples	P-1012868	258h	Spectroscope in Metal Case	P-1003184	178
Set of Four Conductors for Biot-Savart Experiments	P-1018478	221	Spectrum Tube Air	P-1003402	176
Set of Fuses	P-1012873	300	Spectrum Tube Argon	P-1003403	176
Set of Helical Springs for Hooke's Law	P-1003376	53	Spectrum Tube Bromine	P-1003404	176
Set of Hook Weights and Thread	P-1019180	63, 295	Spectrum Tube Carbon Dioxide	P-1003405	176
Set of Optical Components	P-1002993	149	Spectrum Tube Chlorine	P-1003406	176
Set of Plotter Paper	P-1003361	65	Spectrum Tube Deuterium	P-1003407	176
Set of Riders for Rulers	P-1006494	50	Spectrum Tube Helium	P-1003408	176
Set of Seals	P-1002672	139	Spectrum Tube Hydrogen	P-1003409	176
Set of Slotted Weights, 10 x 10 g	P-1003227	54	Spectrum Tube Iodine	P-1003410	176
Set of Slotted Weights, 10 x 10 g, Red and Grey	P-1000773	54	Spectrum Tube Krypton	P-1003411	176
Set of Slotted Weights, 20 – 100 g	P-1003226	54	Spectrum Tube Mercury	P-1003412	176
Set of Slotted Weights, 4 x 100 g, Red and Grey	P-1000777	54	Spectrum Tube Neon	P-1003413	176
Set of Slotted Weights, 5 x 100 g	P-1003229	54	Spectrum Tube Nitrogen	P-1003414	176
Set of Slotted Weights, 5 x 50 g	P-1003228	54	Spectrum Tube Oxygen	P-1003415	176
Set of Slotted Weights, 8 x 50 g, Red and Grey	P-1000775	54	Spectrum Tube Power Supply (115V, 50/60 Hz)	P-1000683	176
Set of Special Carbon Paper	P-1003366	65	Spectrum Tube Power Supply (230V, 50/60 Hz)	P-1000684	176
Set of Test Bodies for Torsion Axle	P-1008663	82	Spectrum Tube Water Vapor	P-1003416	176
Set of Tuning Forks for the C-Major Scale	P-1002605	109	Spectrum Tube Xenon	P-1003417	176
Set of Tuning Forks, C-Major Chord, on Resonance Boxes	P-1002615	109	Spectrum Tubes and Spectrum Lamps	–	176 – 177
Set of Weights 1 g to 1000 g	P-1003212	54	Speed of Light	–	190
Set of Weights 1 g to 50 g	P-1003210	54	Speed of Light Meter (115 V, 50/60 Hz)	P-1000882	190
			Speed of Light Meter (230 V, 50/60 Hz)	P-1000881	190
			Sphere for Weighing Gases 1000 ml	P-1003519	85
			Spintharoscope	P-1000918	260
			Spirit Lamp	P-1003565	291
			Stability Apparatus	P-1002950	57

Description	Art. No.	Page
Stable Tube-Type Thermometer -1 – 101°C	P-1003013	124 – 125
Stainless Steel Rod 100 mm	P-1002932	298
Stainless Steel Rod 1000 mm	P-1002936	298
Stainless Steel Rod 1500 mm	P-1002937	298
Stainless Steel Rod 250 mm	P-1002933	298
Stainless Steel Rod 470 mm	P-1002934	298
Stainless Steel Rod 750 mm	P-1002935	298
Stainless Steel Rod, 280 mm, 10 mm diam.	P-1012848	298
Stainless Steel Rod, 400 mm, 10 mm diam.	P-1012847	298
Stand Base, A-Shaped 200 mm	P-1001044	296
Stand Base, A-Shaped 280 mm	P-1001043	296
Stand for Cylindrical Coils	P-1000964	220
Stand with H-Shaped Base	P-1018874	296
Stands, Clamps and Accessories	–	296 – 298
Statics	–	57
Steam Engine B	P-1012801	145
Steam Engine G	P-1002597	145
Steam Generator (115 V, 50/60 Hz)	P-1006769	131
Steam Generator(230 V, 50/60 Hz)	P-1001049	131
Steel Balls, Set of 3	P-4003748	67
Steel Balls, Set of 6	P-1002939	68
Steel Safe for Radioactive Materials	P-1000920	261
Stefan Boltzmann Lamp	P-1008523	135
Stereophonic Hearing	–	107
Stirling Engine D	P-1000817	142
Stirling Engine G	P-1002594	141
Stirling Engine S	P-1003505	143
Storage Box	P-1003571	150 – 151
Storing Base for Lenses	P-1003034	159
Straight Conductor on Acrylic Base	P-1000926	219
Striking Hammer, Hard	P-1002610	109
Striking Hammer, Soft	P-1002614	109
Stroboscope, Digital (115 V, 50/60 Hz)	P-1003330	285
Stroboscope, Digital (230 V, 50/60 Hz)	P-1003331	285
Student Experiment Kits (SEK)	–	16 – 31
Student Experiments	–	8 – 37
STUDENT Kit – Basic Set	P-1000730	8
STUDENT Kit – Electricity	P-1017213	12 – 14
STUDENT Kit – Electrostatics	P-1009883	14
STUDENT Kit – Heat	P-1000732	10
STUDENT Kit – Mechanics	P-1000731	9
STUDENT Kit – Optics (115 V, 50/60 Hz)	P-1000733	11
STUDENT Kit – Optics (230 V, 50/60 Hz)	P-1000734	11
Supplemental Set “Optics with Laser Ray Box”	P-1003050	148
Supplementary Kit for Rotating System on Air Bed	P-1000783	72
Supplementary Set for Interference	P-1009700	32 – 33
Supplementary Set for Polarisation	P-1009701	32 – 33
Supplementary Set for Stirling Engine D	P-1008516	142
Supplementary Set for Torsion Apparatus	P-1018787	89
Support for Optical Bench D	P-1012399	155
Surface Tension	–	87
Surface Tension Ring	P-1000797	87
Suspended Magnet	P-1000943	214
SW Physical Pendulum Set	P-1012853	78 – 79
SW Sensors Set (115 V, 50/60 Hz)	P-1012851	78 – 79
SW Sensors Set (230 V, 50/60 Hz)	P-1012850	78 – 79
SW Stand Equipment Set	P-1012849	298
SW String Pendulum Set	P-1012854	78 – 79
SW Wilberforce Pendulum Set	P-1012844	78 – 79
Switch Box	P-1019301	62 – 63
Switch on 3B-Box	P-1010139	200 – 201
Switch, Single, P4W50	P-1012993	208
Swivel Joint for Optical Bench D	P-1002632	155
Swivel Joint with Scale	P-1003043	153
– T –		
Table Clamp	P-1002832	297
Table Top Stop Clock	P-1002809	49
Table-Top Power Supply	P-1017579	136, 267
Tandem Pulley, 2 Pulleys	P-1003222	60
Tandem Pulley, 3 Pulleys	P-1003223	60
TaS ₂ Sample	P-1012876	247
TaSe ₂ Sample	P-1012875	247
TELTRON®	–	232 – 242
Temperature Sensor	P-1017898	128
Temperature Sensor, Pt100	P-1000550 42,	124 – 125
Temperature Sensor, Pt100 with Measurement Terminal	P-1009922	42, 144
Temperature Sensor, TC – K	P-1000551 42,	124 – 125
Tension Ring DN 10/16 KF	P-1002930	93
Tesla Transformer	P-1000966	231
Teslameter 200 mT (115 V, 50/60 Hz)	P-1003313	286
Teslameter 200 mT (230 V, 50/60 Hz)	P-1003314	286
Teslameter E	P-1008537	286
Test Bodies for Torsion Axle, Set	P-1008663	82
Test Vessel, Complete	P-1002578	112
Thermal Conductivity Equipment Kit	P-1003497	133
Thermal Expansion	–	130 – 132
Thermocouples, Set of 3	P-1017904	295
Thermometer	–	124 – 127

Description	Art. No.	Page
Thermometer +10 – 30°C	P-1003527	124 – 125
Thermometer -10 – 150°C	P-1003385	124 – 125
Thermometer -10°C – 200°C	P-1003525	124 – 125
Thermometer -20 – 110°C	P-1003384	124 – 125
Thermometer -20 – 110°C / 0 – 230°F	P-1003386	124 – 125
Thermometer -20 – 150°C / 0 – 300°F	P-1003387	124 – 125
Thermometer clip	P-1003528	124 – 125
Thomson Tube S	P-1000617	237
Thyristor, TYN 1012, P4W50	P-1012979	208
Tilting Rider D	P-1012467	154
Timer	P-1003009	49
Toggle Switch on Acrylic Base	P-1000960	198
Torsion Apparatus	P-1018550	89
Torsion Axle	P-1008662	82
Total Reflection Apparatus on Stem	P-1000857	158
T-Piece DN 16 KF	P-1002925	93
T-Piece, BNC	P-1002752	301
Tracing Compasses, Set of 10	P-1003095	217
Training Oscilloscope	P-1000902	243
Transformer	–	228 – 231
Transformer 12 V, 25 VA (115 V, 50/60 Hz)	P-1000865	266
Transformer 12 V, 25 VA (230 V, 50/60 Hz)	P-1000866	266
Transformer 12 V, 60 VA (115 V, 50/60 Hz)	P-1006780	266
Transformer 12 V, 60 VA (230 V, 50/60 Hz)	P-1000593	266
Transformer Core D	P-1000976	228
Transformer Core S	P-100P-1004	230
Transformer with Rectifier		
2/ 4/ 6/ 8/ 10/ 12/ 14 V, 5 A (115 V, 50/60 Hz)	P-1003557	267
Transformer with Rectifier		
2/ 4/ 6/ 8/ 10/ 12/ 14 V, 5 A (230 V, 50/60 Hz)	P-1003558	267
Transformer with Rectifier 3/ 6/ 9/ 12 V, 3 A (115 V, 50/60 Hz)	P-1003315	267
Transformer with Rectifier 3/ 6/ 9/ 12 V, 3 A (230 V, 50/60 Hz)	P-1003316	267
Transformer, Demountable	–	228 – 230
Transistor FET , BF 244, P4W50	P-1012978	208
Transistor NPN , BC 550, P4W50	P-1012976	208
Transistor NPN , BD 137, P4W50	P-1012974	208
Transistor NPN BC140, P4W50	P-1018845	208
Transistor PNP BC160, P4W50	P-1018846	208
Transistor PNP, BC 560, P4W50	P-1012977	208
Transistor PNP, BD 138, P4W50	P-1012975	208
Transmission Grating 300 Lines/mm	P-1003080	162
Transmission Grating 600 Lines/mm	P-1003079	162
Transparent Acrylic Plate	P-1000880	197
Transport Case KL	P-1008651	184 – 187
Triac, BT 137/800, P4W50	P-1012980	208
Trigger Device for Maxwell's Wheel	P-1018075	70
Triode D	P-1000647	234
Triode S	P-1000614	239
Triple/Quintuple Slit N	P-4004057	152
Tripod Stand 150 mm	P-1002835	296
Tripod Stand 185 mm	P-1002836	296
Trolley Track, 1.8m	P-1018102	61
Tube Holder D	P-1008507	236
Tube Holder S	P-1014525	241
Tube Thermometer, Graduated -10 – 110°C	P-1002879	124 – 125
Tube Thermometer, not Graduated	P-1002880	124 – 125
Tube with 6 Induction Coils	P-1001005	225
Tubing	–	298
Tubing, Silicone 6 mm	P-1002622	298
Tungsten Wire	P-1009718	56
Tuning Fork 21 Hz with Plotter Pen	P-1000805	108
Tuning Fork, 2000 Hz	P-1002609	108
Tuning Fork, 440 Hz, on Resonance Box	P-1002613	108
Tuning Forks for the C-Major Scale, Set of	P-1002605	109
Tuning Forks, 440 Hz, on Resonance Boxes, Pair of	P-1002612	109
Tuning Forks, C-Major Chord, on Resonance Boxes, Set of	P-1002615	109
Tuning Weights, Pair	P-1002611	109
Turn Table	P-1003490	74
Two Way Ball Valve DN 16 KF	P-1002923	93
Two-Channel Function Generator, 20 MHz	P-1008677	274
Two-pole Switch	P-1018439	295
Tyndall's Bar Breaker	P-1000829	130
Type K/I/R Thermometer	P-1002799	127
– U –		
U Core D	P-1000979	230
Ultrasonic Adaptor Lead	P-1018750	301
Ultrasonic Coupling Gel	P-1008575	116
Ultrasonic cw Generator with Probe	P-1002576	112
Ultrasonic Doppler Apparatus	P-1002571	117
Ultrasonic Echoscope GS200	P-1018616	113
Ultrasonic Motion Sensor	P-1000559	41
Ultrasonic Probe 1MHz GS200	P-1018617	114
Ultrasonic Probe 2MHz GS200	P-1018618	114
Ultrasonic Probe 4MHz GS200	P-1018619	114
Ultrasonic Probe, 2 MHz	P-1002582	118
Ultrasound	–	111 – 119

Description	Art. No.	Page
Ultrasound in Solids, Equipment Set	P-1002584	114
Ultrasound Transducer 40 kHz Equipment Kit	P-1009888	111
Undoped Germanium on Printed Circuit Board	P-1008522	264 – 265
Uniform Acceleration	–	68
Universal Areometer	P-1002876	84
Universal Clamp	P-1002830	297
Universal Holder on 3B Box	P-1010156	200 – 201
Universal Jaw Clamp	P-1002833	297
Universal Spirit Level, 250 mm	P-1002604	57
Unknown Resistors in 3B Box	P-1012699	200 – 201
USB Interface	P-1003431	289
USB Oscilloscope 2 x 50 MHz	P-1017264	276 – 277
U-Tube Manometer D	P-1009714	86
U-Tube Manometer S	P-1000792	86
UV A/B Sensor	P-1000567	42
– V –		
Vacuum	–	90 – 91
Vacuum Bell Jar	P-1003167	91
Vacuum Chamber with Hand Pump	P-1010126	90
Vacuum Experiment Plate	P-1003166	91
Vacuum Hand Pump	P-1012856	92
Vacuum Hose, 10 mm	P-1002620	92, 298
Vacuum Hose, 4 mm	P-1012831	92, 298
Vacuum Hose, 6 mm	P-1012830	92, 298
Vacuum Hose, 8 mm	P-1002619	92, 298
Vacuum Photocell	P-1000915	253
Vacuum Pumps	–	92 – 93
Vacuum Recipient	P-1009943	91
Vacuum Student Kit	P-1003494	34
Van de Graaff Generator (115 V, 50/60 Hz)	P-1002963	192
Van de Graaff Generator (230 V, 50/60 Hz)	P-1002964	192
Vane Wheel	P-1003101	133
Variable g Pendulum	P-1000755	76
Variable Inductance Coil	P-1003194	226
Variable Leak Valve, DN 16 KF	P-1018822	93
Variable-Focus Lens	P-1003030	157
VDR Resistor, P2W19	P-1018841	207
Velocity of Sound in Air	–	103
Velocity of Sound in Solid Objects	–	107
Ventilation Valve DN 16 KF	P-1002926	93
Vernier Model	P-1002951	51
Vertical and Horizontal Trajectories	–	68 – 70
Vertical Ruler, 1 m	P-1000743	50
Vessel with Overflow, Metal	P-1009713	51
Vessel with Overflow, Transparent	P-1003518	51
Vibration Generator	P-1000701	100
Video Cameras	–	292 – 293
Viscosity	–	88
Vision Viewer	P-1003436	292 – 293
Volta's Pile on 3B Box	P-1010132	200 – 201
Voltage Regulating Transformer (230 V, 50/60 Hz)	P-1002772	267
Voltmeter, AC	P-1002789	278
Voltmeter, DC	P-1002787	278
Volumetric Dilatometer	P-1018001	132
– W –		
Waltenhofen's Pendulum	P-1000993	226
Warning Notice: "Radioactive"	P-1000919	261

Description	Art. No.	Page
Watch Glass Dishes, 120 mm, Set of 10	P-1002869	302
Watch Glass Dishes, 80 mm, Set of 10	P-1002868	302
Water Wave Channel	P-1000807	99
Water Waves	–	98
Water-Jet Pump	P-1003008	92
Watt's Governor	P-1009695	73
Wave Machine, Manual	P-1003524	102
Wave Optics	–	96 – 97
Wave Optics with Laser, Equipment Set for	P-1003053	169
Waveguide Optics, Equipment set	P-1003054	189
Waves and Particles	–	232, 240
Waves and Sound	–	96 – 119
Weather	–	122
Weather Station, Wireless	P-1010248	123
Wedge-Shaped Vessel	P-1000794	87
Weight Holders with Slotted weights, Set of 3	P-1000676	55
Weights 1 g to 1000 g, Set of	P-1003212	54
Weights 1 g to 50 g, Set of	P-1003210	54
Weights 1 g to 500 g, Set of	P-1010189	55
Weights 1 g to 500 g, slotted with Holder, Set of	P-1018597	54
Weights 1 mg to 500 mg, Set of	P-1010234	55
Weights 10 g to 1000 g, Set of	P-1003214	54
Weights 100 g to 2000 g, Set of	P-1001052	54
Weights with Hooks, Set of	P-1010168	55
Weights, 10 g, Set of 10	P-1000770	54
Weights, 20 g, Set of 10	P-1000769	54
Weights, 50 g, Set of 10	P-1000771	54
Whiteboard 600x900 mm ²	P-1002591	147, 295
Whiteboard 900x1200 mm ²	P-1002592	147, 295
Whiteboards	–	295
Wick	P-1001048	291
Wide-Band Loudspeaker	P-1000812	111
Wimshurst Machine	P-1002967	192
Wireless Weather Station	P-1010248	123
Wooden Blocks for Friction Experiments	P-1002944	58
Wooden Rulers, 0.5 m, Set of 10	P-1003234	51
Wooden Rulers, 1 m, Set of 10	P-1003233	51
WSe ₂ Sample	P-1012874	247
– X –		
X-Ray Apparatus (115 V, 50/60 Hz)	P-1000660	258a
X-Ray Apparatus (230 V, 50/60 Hz)	P-1000657	258a
X-Ray Energy Detector	P-1008629	258f – g
X-Rays	–	258a-h
– Y –		
Yi Bell	P-1003207	303
Young's Modulus Supplementary Set	P-1018528	89
Young's Modulus	–	89
– Z –		
Zener Diode, ZPD 18, P2W19	P-1012970	207
Zener Diode, ZPD 3.3, P2W19	P-1012965	207
Zener Diode, ZPD 6.2, P2W19	P-1012967	207
Zener Diode, ZPD 9.1, P2W19	P-1012966	207
Zener Diode, ZPY 5.6, P2W19	P-1012968	207
Zener Diode, ZPY 8.2, P2W19	P-1012969	207
Zero Point Galvanometer CA 403	P-1002726	279
Zinc Plates, Set of 10	P-1002713	213
Zinc Sample for Hall Effect	P-1018752	265

Art. No.	Page	Art. No.	Page	Art. No.	Page	Art. No.	Page	Art. No.	Page
P-1000009	39	P-1000558	42	P-1000593	266	P-1000622	240	P-1000667	258b
P-1000011	238	P-1000559	41	P-1000596	163	P-1013889	240	P-1000668	258h
P-1000259	191	P-1000560	41	P-1000597	163	P-1000624	242	P-1000669	258h
P-1000345	116	P-1000561	41	P-1000598	163	P-1000633	256 – 257	P-1000670	258h
P-1000536	252	P-1000562	44	P-1000599	163	P-1000637	262 – 263	P-1000674	217
P-1000537	252	P-1000563	40, 49	P-1000600	163	P-1000638	262 – 263	P-1000675	156
P-1000539	39	P-1000564	40	P-1000601	163	P-1000640	262 – 263	P-1000676	55
P-1000540	39	P-1000565	41	P-1000602	162	P-1000642	262 – 263	P-1000680	81, 266
P-1000541	39	P-1000566	46	P-1000603	163	P-1000644	236	P-1000681	81, 266
P-1000542	46	P-1000567	42	P-1000604	146	P-1000645	236	P-1000682	147
P-1000543	46	P-1000568	41	P-1000605	63, 94	P-1000646	234	P-1000683	176
P-1000544	38	P-1000569	43	P-1000606	63, 94	P-1000647	234	P-1000684	176
P-1000545	43	P-1000570	46	P-1000607	161	P-1000648	233	P-1000685	202
P-1000546	43	P-1000571	46	P-1000608	159	P-1000649	233	P-1000686	202
P-1000547	43	P-1000572	205	P-1014525	241	P-1000650	233	P-1000687	202
P-1000548	43	P-1000573	205	P-1000611	241	P-1000651	232	P-1000688	202
P-1000549	43	P-1000575	44	P-1000613	239	P-1000653	234	P-1000689	202
P-1000550 42, 124 – 125		P-1000576	44	P-1000614	239	P-1000654	235	P-1000690	202
P-1000551 42, 124 – 125		P-1000579	44	P-1000615	238	P-1000656	236	P-1000694	57
P-1000552	45	P-1000580	218	P-1000616	238	P-1000657	258a	P-1000695	74
P-1000553	45	P-1000581	218	P-1000617	237	P-1000660	258a	P-1000698	74
P-1000554	43	P-1000588	70	P-1000618	239	P-1000661	258c	P-1000699	57
P-1000555	46	P-1000590	226	P-1000619	239	P-1000664	258a	P-1000700	108
P-1000556	45	P-1000591	220	P-1000620	256 – 257	P-1000665	258c	P-1000701	100
P-1000557	41	P-1000592	220	P-1000621	256 – 257	P-1000666	258b	P-1000702	100

Art. No.	Page	Art. No.	Page	Art. No.	Page	Art. No.	Page	Art. No.	Page
P-1000703	100	P-1000851	174	P-1000991	228	P-1002620	92, 298	P-1002787	278
P-1000704	139	P-1000852	177, 253	P-1000992	229	P-1002622	298	P-1002788	278
P-1000705	101	P-1000853	156	P-1000993	226	P-1002627	122	P-1002789	278
P-1000706	101	P-1000854	156	P-1000994	204	P-1002628	154	P-1002790	278
P-1000707	100	P-1000855	158	P-1000995	199	P-1002629	154	P-1002791	127
P-1000730	8	P-1000856	158	P-1000997	21	P-1002630	154	P-1002793	127
P-1000731	9	P-1000857	158	P-1000998	21	P-1002632	155	P-1002794	127
P-1000732	10	P-1000862	150 – 151	P-1000999	230	P-1002635	154	P-1002795	122
P-1000733	11	P-1000863	150 – 151	P-1001000	230	P-1002637	154	P-1002799	127
P-1000734	11	P-1000865	266	P-1001001	230	P-1002639	154	P-1002802	283
P-1000735	48	P-1000866	266	P-1001002	230	P-1002644	154	P-1002803	124 – 125
P-1000738	67	P-1000868	150 – 151	P-1001003	230	P-1002646	155	P-1002804	124 – 125
P-1000739	66	P-1000869	150 – 151	P-1001004	230	P-1002649	160	P-1002805	124 – 125
P-1000740	69	P-1000871	150 – 151	P-1001005	225	P-1002651	183	P-1002806	290
P-1000741	53	P-1000876	150 – 151	P-1001006	268	P-1002652	183	P-1002807	290
P-1000742	50	P-1000878	150 – 151	P-1001007	268	P-1002653	86	P-1002808	290
P-1000743	50	P-1000879	150 – 151	P-1001011	271	P-1002654	68	P-1002809	49
P-1000747	80	P-1000880	197	P-1001012	271	P-1002655	68	P-1002810	49
P-1000748	80	P-1000881	190	P-1001014	266	P-1002656	69	P-1002811	49
P-1000752	84	P-1000882	190	P-1001015	287	P-1002657	69	P-1002827	297
P-1000754	84	P-1000885	162	P-1001016	287	P-1002658	128	P-1002828	297
P-1000755	76	P-1000886	161	P-1001021	287	P-1002659	128	P-1002829	297
P-1000756	76	P-1000887	150 – 151	P-1001022	287	P-1002660	222 – 223	P-1002830	297
P-1000758	94	P-1000889	163	P-1001024	194	P-1002661	222 – 223	P-1002831	297
P-1000760	94	P-1000891	163	P-1001025	194	P-1002662	222 – 223	P-1002832	297
P-1000761	94	P-1000894	120	P-1001026	194	P-1002663	227	P-1002833	297
P-1000762	75	P-1000895	167	P-1001027	193	P-1002670	138	P-1002834	296
P-1000763	75	P-1000901	243	P-1001028	287	P-1002671	139	P-1002835	296
P-1000764	75	P-1000902	243	P-1001029	196	P-1002672	139	P-1002836	296
P-1000765	95	P-1000904	244	P-1001030	196	P-1002689	120	P-1002837	155
P-1000766	85	P-1000906	225, 244	P-1001032	49, 259, 284	P-1002698	52	P-1002838	299
P-1000768	83	P-1000912	254 – 255	P-1001033	49, 259, 284	P-1002699	52	P-1002839	299
P-1000769	54	P-1000913	258	P-1001034	40, 49	P-1002700	52	P-1002840	299
P-1000770	54	P-1000915	253	P-1001035	259	P-1002701	52	P-1002841	299
P-1000771	54	P-1000916	253	P-1001036	272	P-1002702	53	P-1002843	300
P-1000773	54	P-1000917	252	P-1001037	272	P-1002703	53	P-1002847	299
P-1000775	54	P-1000918	260	P-1001038	273	P-1002704	53	P-1002848	300
P-1000777	54	P-1000919	261	P-1001040	286	P-1002705	170	P-1002849	300
P-1000779	66	P-1000920	261	P-1001041	101	P-1002707	194	P-1002850	299
P-1000780	66	P-1000921	260	P-1001043	296	P-1002708	194	P-1002851	300
P-1000781	72	P-1000923	193	P-1001044	296	P-1002709	194	P-1002858	166
P-1000782	72	P-1000924	192	P-1001045	296	P-1002710	298	P-1002859	166
P-1000783	72	P-1000925	219	P-1001046	296	P-1002711	213	P-1002860	166
P-1000786	53	P-1000926	219	P-1001048	291	P-1002712	213	P-1002861	166
P-1000789	17	P-1000927	219	P-1001049	131	P-1002713	213	P-1002862	167
P-1000790	70	P-1000928	219	P-1001052	54	P-1002714	213	P-1002863	166
P-1000791	83	P-1000929	214	P-1001054	199	P-1002715	213	P-1002864	166
P-1000792	86	P-1000932	197	P-1001055	295	P-1002716	213	P-1002865	166
P-1000793	87, 301	P-1000933	197	P-1001056	174	P-1002717	213	P-1002866	184
P-1000794	87	P-1000934	197	P-1001057	174	P-1002719	211	P-1002867	83
P-1000796	85	P-1000936	197	P-1002571	117	P-1002720	211	P-1002868	302
P-1000797	87	P-1000938	194	P-1002572	118	P-1002721	175	P-1002869	302
P-1000798	92	P-1000942	218	P-1002573	118	P-1002722	29, 259	P-1002870	301, 302
P-1000801	67	P-1000943	214	P-1002574	116	P-1002726	279	P-1002871	302
P-1000804	110	P-1000946	198	P-1002575	117	P-1002727	275	P-1002872	302
P-1000805	108	P-1000947	198	P-1002576	112	P-1002730	203	P-1002873	302
P-1000806	110	P-1000948	199	P-1002577	112	P-1002731	203	P-1002874	84
P-1000807	99	P-1000949	198	P-1002578	112	P-1002732	203	P-1002875	84
P-1000808	101	P-1000950	198	P-1002579	112	P-1002733	203	P-1002876	84
P-1000811	111	P-1000951	198	P-1002582	118	P-1002734	203	P-1002877	122
P-1000812	111	P-1000953	198	P-1002584	114	P-1002735	203	P-1002879	124 – 125
P-1000814	103	P-1000954	198	P-1002585	114	P-1002736	203	P-1002880	124 – 125
P-1000815	103	P-1000955	198	P-1002586	114	P-1002737	203	P-1002881	124 – 125
P-1000816	15	P-1000956	198	P-1002587	114	P-1002744	274	P-1002882	135
P-1000817	142	P-1000957	198	P-1002588	115	P-1002745	275	P-1002884	175
P-1000819	144	P-1000958	198	P-1002589	115	P-1002746	301	P-1002885	175
P-1000820	144	P-1000959	198	P-1002590	115	P-1002748	301	P-1002889	132
P-1000821	129	P-1000960	198	P-1002591	147, 295	P-1002749	301	P-1002891	87
P-1000822	129	P-1000961	198	P-1002592	147, 295	P-1002750	301	P-1002892	86
P-1000823	128	P-1000962	198	P-1002593	295	P-1002751	301	P-1002894	140
P-1000824	121, 134	P-1000964	220	P-1002594	141	P-1002752	301	P-1002895	140
P-1000827	130	P-1000965	220	P-1002597	145	P-1002753	45	P-1002897	213
P-1000828	130	P-1000966	231	P-1002598	143	P-1002754	45	P-1002898	212
P-1000829	130	P-1000967	231	P-1002599	143	P-1002760	270	P-1002899	212
P-1000830	131	P-1000968	224	P-1002600	50	P-1002761	270	P-1002903	133
P-1000831	130	P-1000972	194	P-1002601	50	P-1002762	270	P-1002904	303
P-1000832	301	P-1000976	228	P-1002602	50	P-1002763	270	P-1002905	242
P-1000833	301	P-1000977	230	P-1002603	50	P-1002769	268	P-1002906	174
P-1000834	301	P-1000978	230	P-1002604	57	P-1002771	270	P-1002911	179
P-1000835	134	P-1000979	230	P-1002605	109	P-1002772	267	P-1002912	179
P-1000837	121	P-1000980	229	P-1002606	108	P-1002775	268	P-1002917	162
P-1000839	120	P-1000981	229	P-1002607	108	P-1002776	268	P-1002919	93
P-1000840	121	P-1000982	229	P-1002608	108	P-1002777	274	P-1002923	93
P-1000841	152	P-1000983	229	P-1002609	108	P-1002778	283	P-1002924	93
P-1000842	152	P-1000984	228	P-1002610	109	P-1002779	283	P-1002925	93
P-1000843	152	P-1000985	228	P-1002611	109	P-1002780	283	P-1002926	93
P-1000844	152	P-1000986	228	P-1002612	109	P-1002781	280	P-1002927	93
P-1000845	152	P-1000987	228	P-1002613	108	P-1002783	280	P-1002928	93
P-1000846	162	P-1000988	228	P-1002614	109	P-1002784	281	P-1002929	93
P-1000848	161	P-1000989	228	P-1002615	109	P-1002785	280	P-1002930	93
P-1000850	150 – 151	P-1000990	228	P-1002619	92, 298	P-1002786	278	P-1002931	93

Art. No.	Page	Art. No.	Page	Art. No.	Page	Art. No.	Page	Art. No.	Page
P-1002932	298	P-1003064	203	P-1003227	54	P-1003415	176	P-1006798	197
P-1002933	298	P-1003065	203	P-1003228	54	P-1003416	176	P-1006799	217
P-1002934	298	P-1003066	203	P-1003229	54	P-1003417	176	P-1006804	28 – 29
P-1002935	298	P-1003067	203	P-1003230	75	P-1003419	288	P-1006809	281
P-1002936	298	P-1003068	203	P-1003231	35	P-1003421	288	P-1006813	194
P-1002937	298	P-1003069	203	P-1003232	197	P-1003428	289	P-1006889	51
P-1002939	68	P-1003073	278	P-1003233	51	P-1003429	289	P-1007027	88, 301
P-1002940	57	P-1003074	278	P-1003234	51	P-1003431	289	P-1007112	295
P-1002941	296	P-1003078	178	P-1003235	77	P-1003433	288	P-1008500	141
P-1002942	296	P-1003079	162	P-1003237	220	P-1003434	288	P-1008505	245
P-1002943	296	P-1003080	162	P-1003251	222	P-1003436	292 – 293	P-1008506	256 – 257
P-1002944	58	P-1003081	163	P-1003252	225	P-1003489	74	P-1008507	236
P-1002945	53	P-1003082	162	P-1003253	129	P-1003490	74	P-1008508	258c
P-1002946	53	P-1003083	162	P-1003254	129	P-1003491	102	P-1008513	57
P-1002947	50	P-1003084	165	P-1003255	129	P-1003492	102	P-1008516	142
P-1002950	57	P-1003085	214	P-1003256	129	P-1003494	34	P-1008518	150 – 151
P-1002951	51	P-1003086	214	P-1003257	129	P-1003495	86	P-1008519	150 – 151
P-1002952	84	P-1003088	214	P-1003258	129	P-1003496	90	P-1008522	264 – 265
P-1002953	84	P-1003089	214	P-1003307	271	P-1003497	133	P-1008523	135
P-1002954	84	P-1003090	215	P-1003308	271	P-1003498	84	P-1008524	198
P-1002955	84	P-1003091	215	P-1003309	271	P-1003499	85	P-1008525	230
P-1002956	81	P-1003092	218	P-1003310	271	P-1003500	85	P-1008527	16
P-1002957	86	P-1003093	217	P-1003311	270	P-1003501	85	P-1008528	18 – 19
P-1002959	110	P-1003095	217	P-1003312	270	P-1003502	34	P-1008530	22 – 23
P-1002960	110	P-1003096	215	P-1003313	286	P-1003505	143	P-1008531	22 – 23
P-1002963	192	P-1003101	133	P-1003314	286	P-1003507	212	P-1008532	20 – 21
P-1002964	192	P-1003102	52	P-1003315	267	P-1003508	212	P-1008534	269
P-1002965	192	P-1003103	52	P-1003316	267	P-1003509	87	P-1008535	269
P-1002967	192	P-1003104	53, 58	P-1003317	92	P-1003510	87	P-1008537	286
P-1002970	199	P-1003105	53, 58	P-1003321	146	P-1003511	132	P-1008539	60
P-1002975	218	P-1003106	52	P-1003322	146	P-1003512	133	P-1008540	100
P-1002976	218	P-1003107	53, 58	P-1003323	147	P-1003515	53	P-1008575	116
P-1002977	131	P-1003108	52	P-1003324	147	P-1003516	99	P-1008629	258f – g
P-1002978	131	P-1003109	53	P-1003328	162	P-1003518	51	P-1008630	127
P-1002981	137	P-1003110	52	P-1003330	285	P-1003519	85	P-1008631	281
P-1002983	170	P-1003112	214	P-1003331	285	P-1003520	110	P-1008632	184 – 187
P-1002984	146	P-1003114	214	P-1003332	285	P-1003521	110	P-1008634	184 – 187
P-1002985	146	P-1003122	285	P-1003334	126	P-1003522	110	P-1008635	184 – 187
P-1002986	146	P-1003123	285	P-1003335	126	P-1003523	110	P-1008636	184 – 187
P-1002987	146	P-1003157	177	P-1003337	56	P-1003524	102	P-1008637	184 – 187
P-1002988	146	P-1003158	177	P-1003338	190	P-1003525	124 – 125	P-1008638	184 – 187
P-1002989	146	P-1003159	177	P-1003339	190	P-1003526	124 – 125	P-1008639	184 – 187
P-1002990	146	P-1003161	177	P-1003341	62	P-1003527	124 – 125	P-1008640	184 – 187
P-1002992	146	P-1003162	177	P-1003342	63	P-1003528	124 – 125	P-1008641	184 – 187
P-1002993	149	P-1003163	177	P-1003344	63	P-1003531	178	P-1008642	184 – 187
P-1003008	92	P-1003164	159	P-1003345	63	P-1003532	150 – 151	P-1008646	184 – 187
P-1003009	49	P-1003165	156	P-1003346	63	P-1003533	150 – 151	P-1008648	184 – 187
P-1003010	126	P-1003166	91	P-1003347	63	P-1003534	302	P-1008651	184 – 187
P-1003011	122	P-1003167	91	P-1003348	63	P-1003536	120	P-1008652	167
P-1003012	84	P-1003169	91	P-1003349	63	P-1003537	176	P-1008653	139
P-1003013	124 – 125	P-1003170	91	P-1003350	63	P-1003539	176	P-1008654	139
P-1003014	124 – 125	P-1003177	162	P-1003351	63	P-1003541	176	P-1008659	160
P-1003016	158	P-1003178	163	P-1003352	63	P-1003543	176	P-1008661	56
P-1003017	159	P-1003179	163	P-1003354	63	P-1003544	176	P-1008662	82
P-1003019	159	P-1003180	163	P-1003359	65	P-1003545	176	P-1008663	82
P-1003022	157	P-1003181	163	P-1003360	63	P-1003546	176	P-1008664	164
P-1003023	157	P-1003183	178	P-1003361	65	P-1003549	254 – 255	P-1008665	164
P-1003024	157	P-1003184	178	P-1003362	65	P-1003550	254 – 255	P-1008666	164
P-1003025	157	P-1003185	165	P-1003363	65	P-1003554	214	P-1008668	158
P-1003026	157	P-1003186	165	P-1003364	65	P-1003555	216	P-1008669	160
P-1003027	157	P-1003187	149	P-1003366	65	P-1003556	214	P-1008670	165
P-1003028	157	P-1003188	155	P-1003367	70	P-1003557	267	P-1008671	165
P-1003029	157	P-1003189	171	P-1003368	49	P-1003558	267	P-1008672	165
P-1003030	157	P-1003190	302	P-1003369	49	P-1003560	269	P-1008673	179
P-1003031	157	P-1003191	149	P-1003370	52	P-1003561	268	P-1008674	188
P-1003032	157	P-1003192	217	P-1003371	52	P-1003562	268	P-1008675	188
P-1003033	157	P-1003193	220	P-1003372	52	P-1003565	291	P-1008676	276 – 277
P-1003034	159	P-1003194	226	P-1003373	52	P-1003566	291	P-1008677	274
P-1003036	153	P-1003195	176	P-1003374	52	P-1003569	140	P-1008686	303
P-1003038	155	P-1003196	176	P-1003375	52	P-1003570	140	P-1008687	99
P-1003039	153	P-1003197	176	P-1003376	53	P-1003571	150 – 151	P-1008690	269
P-1003040	153	P-1003201	156	P-1003378	83	P-1003593	231, 269	P-1008691	269
P-1003041	153	P-1003202	156	P-1003382	130	P-1003806	191	P-1008692	231, 269
P-1003042	153	P-1003203	158	P-1003383	133	P-1005047	191	P-1008695	275
P-1003043	153	P-1003204	164	P-1003384	124 – 125	P-1005278	248 – 249	P-1008696	175
P-1003044	153	P-1003206	303	P-1003385	124 – 125	P-1005279	248 – 249	P-1008707	261
P-1003048	193	P-1003207	303	P-1003386	124 – 125	P-1005290	248 – 249	P-1008708	261
P-1003049	148	P-1003208	90	P-1003387	124 – 125	P-1005291	248 – 249	P-1009497	184 – 187
P-1003050	148	P-1003209	35	P-1003402	176	P-1005402	294	P-1009545	266
P-1003051	148	P-1003210	54	P-1003403	176	P-1005408	156	P-1009695	73
P-1003052	148	P-1003212	54	P-1003404	176	P-1006494	50	P-1009696	150 – 151
P-1003053	169	P-1003213	60	P-1003405	176	P-1006769	131	P-1009699	150 – 151
P-1003054	189	P-1003214	54	P-1003406	176	P-1006780	266	P-1009700	32 – 33
P-1003055	189	P-1003216	60	P-1003407	176	P-1006784	95	P-1009701	32 – 33
P-1003056	148	P-1003217	60	P-1003408	176	P-1006785	73	P-1009710	215
P-1003057	149	P-1003218	60	P-1003409	176	P-1006790	152	P-1009713	51
P-1003058	149	P-1003221	60	P-1003410	176	P-1006791	152	P-1009714	86
P-1003059	160	P-1003222	60	P-1003411	176	P-1006794	254 – 255	P-1009715	87
P-1003061	181	P-1003223	60	P-1003412	176	P-1006795	254 – 255	P-1009716	227
P-1003062	203	P-1003224	59	P-1003413	176	P-1006796	258	P-1009718	56
P-1003063	203	P-1003226	54	P-1003414	176	P-1006797	29, 260	P-1009733	155

Art. No.	Page	Art. No.	Page	Art. No.	Page	Art. No.	Page	Art. No.	Page
P-1009738	52	P-1010232	123	P-1012886	145	P-1012983	207	P-1018102	61
P-1009739	52	P-1010234	55	P-1012887	145	P-1012984	207	P-1018103	180 – 181
P-1009740	52	P-1010248	123	P-1012889	213	P-1012985	209	P-1018104	180 – 181
P-1009741	52	P-1010250	123	P-1012890	213	P-1012986	209	P-1019196	180 – 181
P-1009760	264 – 265	P-1010252	291	P-1012891	152	P-1012987	209	P-1018106	181
P-1009764	121	P-1010253	291	P-1012892	286	P-1012988	207	P-1018347	289
P-1009765	218	P-1010254	291	P-1012893	110	P-1012989	207	P-1018439	295
P-1009772	289	P-1010255	291	P-1012894	260	P-1012990	207	P-1018448	67
P-1009810	264 – 265	P-1010256	291	P-1012899	266	P-1012991	208	P-1018449	298
P-1009843	202	P-1010300	150 – 151	P-1012900	266	P-1012992	208	P-1018466	77
P-1009844	202	P-1011346	200 – 201	P-1012902	206	P-1012993	208	P-1018468	107
P-1009861	150 – 151	P-1011450	122	P-1012903	206	P-1012994	209	P-1018469	107
P-1009863	150 – 151	P-1011739	290	P-1012904	206	P-1012995	207	P-1018475	103
P-1009864	150 – 151	P-1011768	302	P-1012905	206	P-1013123	216	P-1018476	24
P-1009865	150 – 151	P-1011769	302	P-1012906	206	P-1013131	225	P-1018478	221
P-1009866	150 – 151	P-1012399	155	P-1012907	206	P-1013210	64	P-1018527	89
P-1009883	14	P-1012400	154	P-1012908	206	P-1013228	74	P-1018528	89
P-1009884	195	P-1012401	154	P-1012909	206	P-1013318	251	P-1018532	209
P-1009885	202	P-1012402	154	P-1012910	206	P-1013393	173	P-1018550	89
P-1009886	202	P-1012404	294	P-1012911	206	P-1013412	271	P-1018551	107
P-1009887	202	P-1012467	154	P-1012912	206	P-1013526	279	P-1018581	276 – 277
P-1009888	111	P-1012504	37	P-1012913	206	P-1013527	279	P-1018582	276 – 277
P-1009922	42, 144	P-1012514	93	P-1012914	206	P-1013825	200 – 201	P-1018583	276 – 277
P-1009924	110	P-1012524	37	P-1012915	206	P-1013843	245	P-1018597	54
P-1009925	150 – 151	P-1012526	37	P-1012916	206	P-1013885	232	P-1018616	113
P-1009926	150 – 151	P-1012527	37	P-1012917	206	P-1013904	36	P-1018617	114
P-1009927	150 – 151	P-1012528	37	P-1012918	206	P-1013905	204	P-1018618	114
P-1009929	150 – 151	P-1012569	64	P-1012919	206	P-1013906	204	P-1018619	114
P-1009931	32 – 33	P-1012587	47	P-1012920	206	P-1013907	246	P-1018624	34
P-1009932	32 – 33	P-1012694	200 – 201	P-1012921	206	P-1014520	106	P-1018750	301
P-1009934	264 – 265	P-1012695	200 – 201	P-1012922	206	P-1014521	106	P-1018751	265
P-1009935	230	P-1012696	200 – 201	P-1012923	206	P-1014529	26	P-1018752	265
P-1009941	42	P-1012697	200 – 201	P-1012924	206	P-1014616	288	P-1018753	265
P-1009942	58	P-1012698	200 – 201	P-1012925	206	P-1014617	182	P-1018787	89
P-1009943	91	P-1012699	200 – 201	P-1012926	206	P-1014618	166	P-1018820	172 – 173
P-1009945	152	P-1012741	123	P-1012927	206	P-1014620	164	P-1018822	93
P-1009946	152	P-1012782	247	P-1012928	206	P-1014621	164	P-1018834	55
P-1009948	245	P-1012801	145	P-1012929	206	P-1014622	161	P-1018835	83
P-1009949	202	P-1012816	282	P-1012930	206	P-1016651	26	P-1018836	83
P-1009950	96 – 97	P-1012817	282	P-1012931	206	P-1016652	24	P-1018837	207
P-1009951	96 – 97	P-1012818	254 – 257	P-1012932	206	P-1017213	12 – 14	P-1018839	207
P-1009954	40	P-1012819	254 – 257	P-1012933	206	P-1017264	276 – 277	P-1018841	207
P-1009955	40	P-1012820	258	P-1012934	208	P-1017284	182	P-1018842	207
P-1009956	272	P-1012821	171	P-1012935	208	P-1017329	136	P-1018844	207
P-1009957	272	P-1012827	88	P-1012936	208	P-1017330	136	P-1018845	208
P-1009959	227	P-1012830	92, 298	P-1012937	208	P-1017331	136	P-1018846	208
P-1009960	236	P-1012831	92, 298	P-1012938	208	P-1017332	71	P-1018847	209
P-1009961	236	P-1012832	285	P-1012939	208	P-1017333	106	P-1018874	296
P-1009962	193	P-1012833	285	P-1012940	207	P-1017334	106	P-1018889	215
P-1009963	193	P-1012834	292 – 293	P-1012941	207	P-1017337	273	P-1019180	63, 295
P-1009964	193	P-1012835	292 – 293	P-1012942	207	P-1017338	273	P-1019188	222
P-1010030	161	P-1012836	248 – 249	P-1012943	206	P-1017339	104 – 105	P-1019212	221
P-1010031	161	P-1012837	248 – 249	P-1012944	206	P-1017340	104 – 105	P-1019213	251
P-1010114	302	P-1012838	250	P-1012945	206	P-1017341	106	P-1019214	251
P-1010121	51	P-1012840	250	P-1012946	206	P-1017342	104 – 105	P-1019216	258b
P-1010125	90	P-1012841	250	P-1012947	206	P-1017344	106	P-1019218	300
P-1010126	90	P-1012842	250	P-1012948	206	P-1017366	140	P-1019219	299
P-1010132	200 – 201	P-1012844	78 – 79	P-1012949	206	P-1017531	76	P-1019299	62 – 63
P-1010137	199	P-1012847	298	P-1012950	206	P-1017579	136, 267	P-1019300	62 – 63
P-1010138	200 – 201	P-1012848	298	P-1012951	206	P-1017591	98	P-1019301	62 – 63
P-1010139	200 – 201	P-1012849	298	P-1012952	206	P-1017655	246	P-4000036	132, 302
P-1010140	199	P-1012850	78 – 79	P-1012953	206	P-1017716	300	P-4003748	67
P-1010141	199	P-1012851	78 – 79	P-1012954	206	P-1017718	300	P-4003876	58
P-1010142	199	P-1012853	78 – 79	P-1012955	206	P-1017719	300	P-4003987	152
P-1010143	199	P-1012854	78 – 79	P-1012956	206	P-1017725	271	P-4004002	152
P-1010144	199	P-1012855	92	P-1012957	206	P-1017729	135	P-4004057	152
P-1010145	199	P-1012856	92	P-1012958	206	P-1017730	135	P-4008112	97
P-1010146	200 – 201	P-1012857	270	P-1012959	206	P-1017731	30 – 31	P-4008308	104 – 105
P-1010152	200 – 201	P-1012858	270	P-1012960	206	P-1017732	30 – 31	P-4008573	241
P-1010154	200 – 201	P-1012859	229	P-1012961	207	P-1017734	31	P-4009036	295
P-1010155	200 – 201	P-1012860	168	P-1012962	207	P-1017735	31	P-5006578	44
P-1010156	200 – 201	P-1012861	168	P-1012963	207	P-1017780	210	P-5006663	167
P-1010157	200 – 201	P-1012862	131	P-1012964	207	P-1017781	210		
P-1010158	200 – 201	P-1012863	159	P-1012965	207	P-1017782	119		
P-1010164	227	P-1012865	282	P-1012966	207	P-1017783	119		
P-1010168	55	P-1012868	258h	P-1012967	207	P-1017784	119		
P-1010175	170	P-1012869	116	P-1012968	207	P-1017785	119		
P-1010181	301	P-1012870	140	P-1012969	207	P-1017789	292 – 293		
P-1010189	55	P-1012871	258d – e	P-1012970	207	P-1017801	224		
P-1010190	200 – 201	P-1012872	55	P-1012971	207	P-1017806	206		
P-1010191	200 – 201	P-1012873	300	P-1012972	207	P-1017870	297		
P-1010192	200 – 201	P-1012874	247	P-1012973	207	P-1017874	184 – 187		
P-1010194	170	P-1012875	247	P-1012974	208	P-1017875	134		
P-1010195	199	P-1012876	247	P-1012975	208	P-1017879	184		
P-1010196	199	P-1012877	247	P-1012976	208	P-1017897	128		
P-1010197	199	P-1012878	247	P-1012977	208	P-1017898	128		
P-1010198	199	P-1012880	118	P-1012978	208	P-1017899	128		
P-1010199	199	P-1012882	51	P-1012979	208	P-1017904	295		
P-1010214	51	P-1012883	175	P-1012980	208	P-1018001	132		
P-1010217	50	P-1012884	175	P-1012981	208	P-1018065	195, 302		
P-1010219	126	P-1012885	175	P-1012982	208	P-1018075	70		

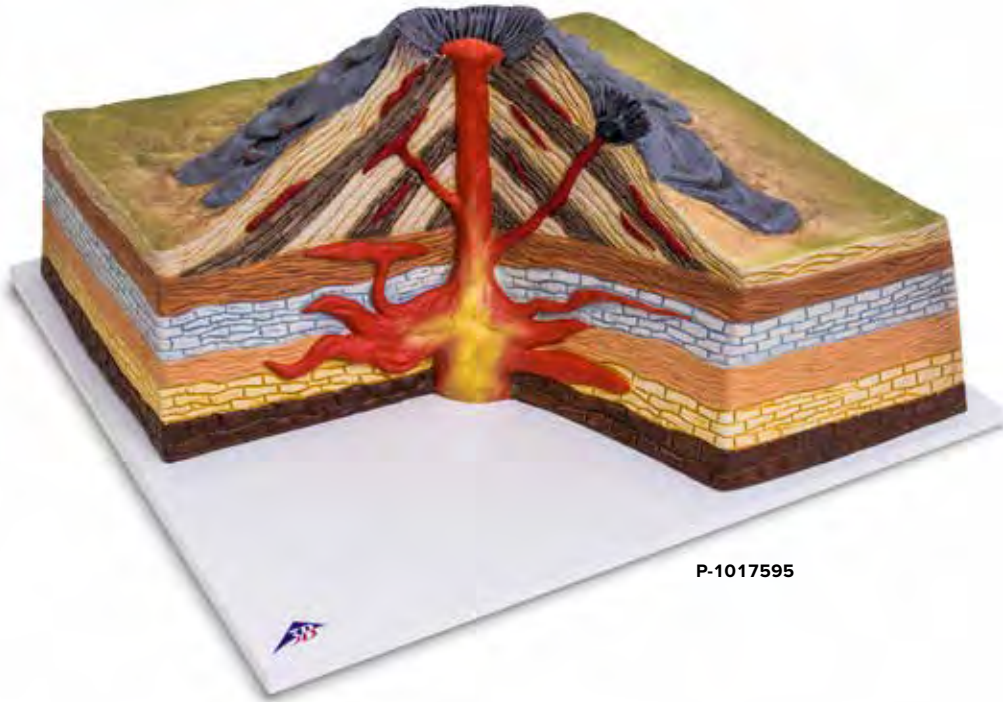

P-1017595

Stratovolcano

This hand-painted model of a stratovolcano with a section removed shows the path of liquid magma through the earth's interior to the exterior.

Material: PVC
 Dimensions: 47x35x19 cm
 Weight: 2.40 kg

P-1017595

Set of three volcanic rocks

Set of three vulcanite rocks consisting of three little bags, each containing ten walnut-sized pieces of lava rock, obsidian and pumice stone.

P-1018462



P-1018462



Mid-Atlantic Ridge

This model shows the S-shaped course in 3D of the volcanic mountain range produced by tectonic shifts in the Atlantic Ocean.

Size at the equator: 1:320.000.000
 Material: PVC
 Dimensions: 64x48x8 cm
 Weight: 6.5 kg

P-1017594

P-1017594



Collection of 24 rocks

The collections contain 24 frequently-occurring examples of various stone and mineral groups. The examples are approx. 3x3x3 cm³ to 5x5x5 cm³ in size, and come in a robust box that includes numbering, labels and information booklet.



Collection of 24 volcanic rocks and minerals

The collection contains volcanic rocks and minerals

Volcanic rocks: basalt, phonolite, pitchstone, rhyolite

Lava: Lava from Vesuvius, basaltic lava and rhyolitic lava

Pyroclasts: lapilli, volcanic ash, pumice stone
Minerals: anorthite, anorthoclase, augite, cristobalite, hauyne, leucite, natrolite, nepheline, pickeringite, sanidine, sulphur, thaumasite, tridymite, obsidian

P-1018442



Collection of 24 rocks

The collection contains frequently occurring examples of metamorphic, sedimentary and magmatic rocks as well as important examples of industrial rocks.

Magmatic rocks, plutonites: foyaite, gabbro, granite, granodiorite, larvikite and monzonite
 Magmatic rocks, vulcanites: basalt, pumice stone, phonolite, rhyolite

Sedimentary rocks: breccia, dolomite, gypsum, limestone, chalk, quartzite and sandstone

Metamorphic rocks: amphibolite, eclogite, mica schist, gneiss, marble, phyllite and serpentinite

P-1018443



Collection of 24 minerals

The collection contains examples of ten classes of minerals: elements, sulphides, halogenides, oxides, carbonates, borates, sulphates, silicates, phosphates and organic compounds.

1. **Elements:** graphite and sulphur
2. **Sulphides:** bournonite, galenite and pyrite
3. **Halogenides:** fluorite and halite
4. **Oxides:** hematite, quartz and rutile
5. **Carbonates:** calcite and dolomite
6. **Borates:** ludwigite
7. **Sulphates:** barite, coelestine and gypsum
8. **Phosphates, arsenates and vanadates:** apatite and vanadite
9. **Silicates and germanates:** actinolite, amazonite, muscovite, sodalite and talc
10. **Organic compound:** copal

P-1018444

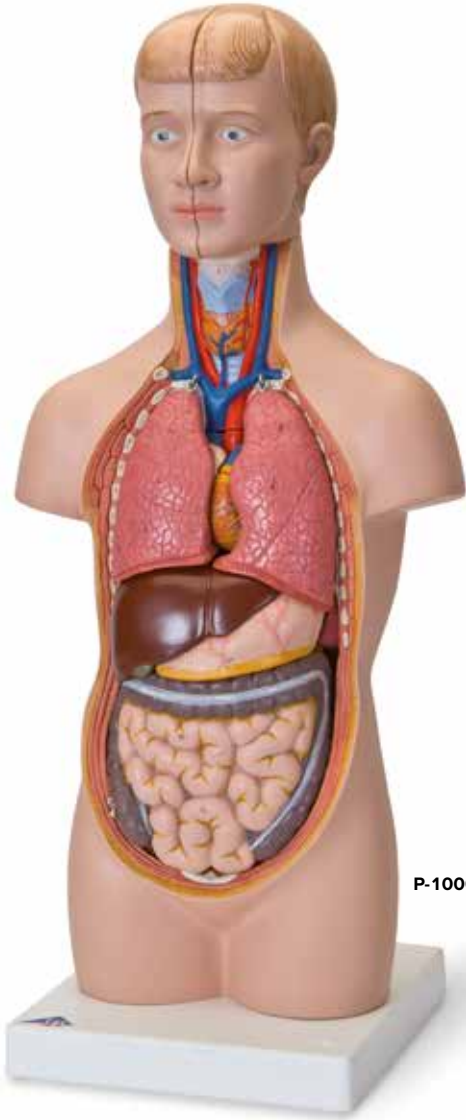

P-1000195

Mini Torso, 12-part

This torso is approximately half life size. Even small hands can quickly disassemble it, removing:

- 2-head halves
- Brain half
- 2 lungs
- 2-part heart
- Stomach
- Liver with gall bladder
- 2-part intestinal tract

54x24x18 cm; 1,89 kg
P-1000195



P-1000259

Eye, 5 times full size, 6-part

This model dissects into:

- Both halves of sclera with cornea and eye muscle attachments
- Both halves of the choroid with iris and retina
- Lens
- Vitreous humour

On base. 9x9x15 cm; 0.1 kg

P-1000259



P-1001294

Anthropological Skull – La Chapelle-aux-Saints

Cast from a reconstruction of the La Chapelle-aux-Saints skull, the model skull is an accurate copy of one belonging to a 50-55 year old male Neanderthal from ancient Europe of the species Homo (sapiens) neanderthalensis. Early man. Discovered in southern France Discovery: 1908; Age: Approximately 35,000 to 45,000 years. 22x16x22.5 cm; 0.9 kg

P-1001294

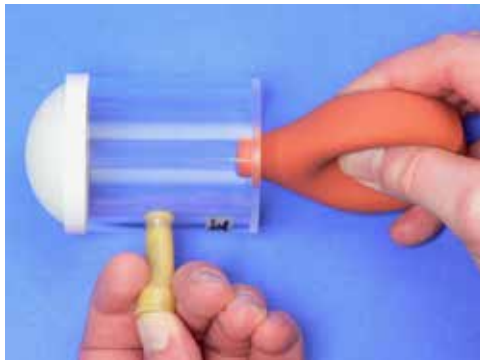

P-1012829



Pressure equalisation in the middle ear

This functional model shows the pressure equalising mechanism of the middle ear via the auditory tube. Bulging out or denting in of the eardrum and the subsequent equalisation of the pressure are demonstrated. Delivered with replacement membrane and teachers' manual. 16x13x12 cm, 0.2 kg

P-1012829

The Plant Cell

magnified 500,000-1,000,000 times

The two-piece model presents the structure of a typical plant cell with cytoplasm and cell organelles, as viewed from an electron microscope. For better illustration, all important organelles are raised and displayed in colour, e.g.:

- Cell wall
 - Cell membrane
 - Nucleus
 - Smooth Endoplasmic Reticulum
 - Rough Endoplasmic Reticulum
 - Ribosomes
 - Chloroplasts
 - Mitochondria
 - Dictyosomes/Golgi apparatus
- 20x14x32 cm; 0.8 kg

P-1000524



P-1000524

miniDNA™ 22 Layer Molecular Model

The miniDNA™ system comprises abstract shaped colour coded parts to represent the nitrogenous bases, pentagonal sugar and pyramidal phosphate parts required to make the Double helix model of DNA.

Contents: 11 Thymine (orange), 11 Adenine (blue) 11 Guanine (green), 11 Cytosine (yellow), 44 Deoxyribose (red), 44 Phosphate (purple)

Supplied with assembly instructions and its own stand. Packed in a plastic box. 44 cm; diam 11 cm

P-1005297



P-1005297



P-1005971

The Life of the Honeybee – Apis cerana

These vividly illustrative embedded specimens give your students an excellent insight into the world of the honeybee. Included are high quality specimens of 1. Egg, 2. Larva, 3. Pupa, 4 Adult (Worker), 5 Adult (Drone), 6. Adult (Queen), 7. The Base of Nest, 8. Worker Comb, 9. Queen Comb, 10. Bee Pollen, 11. Honey, 12. Wax.

165x80x25 mm; 150 g
P-1005971



P-1000530

Cherry Blossom with Fruit (Prunus Avium)

This model shows the blossom of the sweet cherry (3-parts) enlarged 7 times as well as a cherry fruit enlarged 3 times. The cherry blossom can be split into two halves to reveal the removable ovary with style and stigma.

32,5 cm; 0,6 kg
P-1000530



P-1001267

Fire Salamander (Salamandra salamandra)

A salamander which will be particularly loved by younger students. The fire salamander is painted with stunning realism and its identifying characteristics are clear to see. It is a life-size facsimile modelled on natural background.

P-1001267



P-1010264



DNA Extraction from Onion

With this easy test on the theme of cellular biology and genetics, you can isolate chromosomal DNA from an onion without a long preparation time, during a class. Your students will learn thanks to this experiment about the basic process of DNA extraction. Everything is included in the kit so that 5 groups can work at the same time. This effective classroom experiment with a high DNA yield will provide enjoyment for your students.

Contents for 15 experiments:

80 ml extraction buffer, 500 mg protease mix, 15 flat-bottomed tubes, 15 round paper filters, 5 funnels, 15 wooden picks, experiment instructions (multilingual).
 Dimensions: 20.5x20.5x10.5 cm
 Weight: 534 g

P-1010264

Monocular Course Microscope Model 300 (230 V, 50/60 Hz)

The model 300 course microscope meets all the requirements for high-quality biology lessons. It is characterised by its ease of use and its fine mechanical and optical qualities. It is equipped with an object stage, 4-objective revolver with DIN achromatic objectives featuring 4x, 10x, 40x, 100x magnification and an Abbe condenser.

P-1003271



P-1003271

Dissecting instruments

This first-rate dissecting set contains top-quality stainless steel instruments in an attractive vinyl case.

- 1 pair of scissors, pointed, 10 cm
 - 1 pair of forceps, pointed, 13 cm
 - 1 dissecting needle, 13.5 cm
 - 1 scalpel blade holder n° 4
 - 5 replacement scalpel blades n° 11
- 18x8x3 cm, 0,15 kg

P-1008710



P-1008710

3B Scientific® Physics Production in Germany, Klingenthal

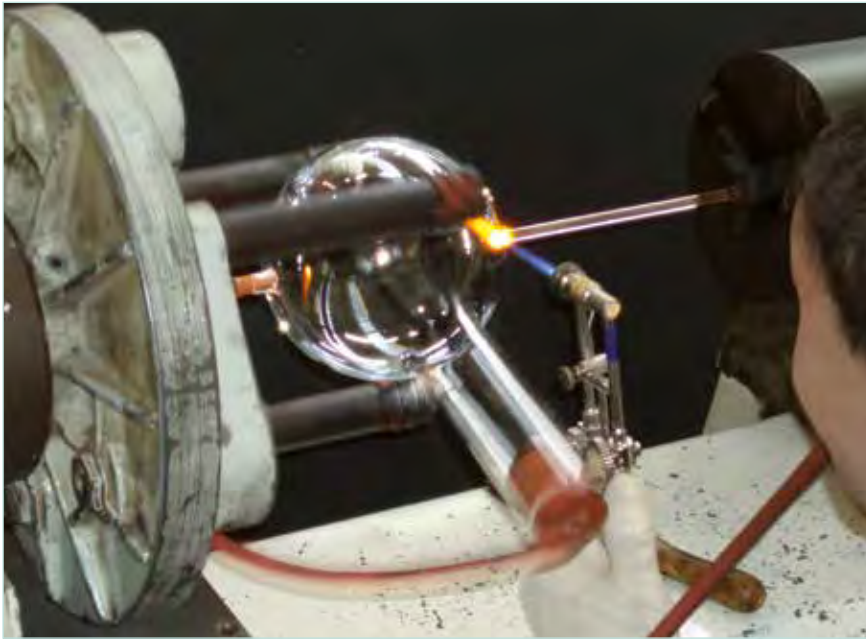

Manufacturing a TELTRON® electron tube at 3B Scientific in Germany

Electron tubes are produced at only a very small number of places in the world. Only specially trained technicians with many years of experience have the skills that are needed for this technologically advanced manufacturing process, which ensures that every TELTRON® electron tube that you receive from us will have the same consistently high quality.

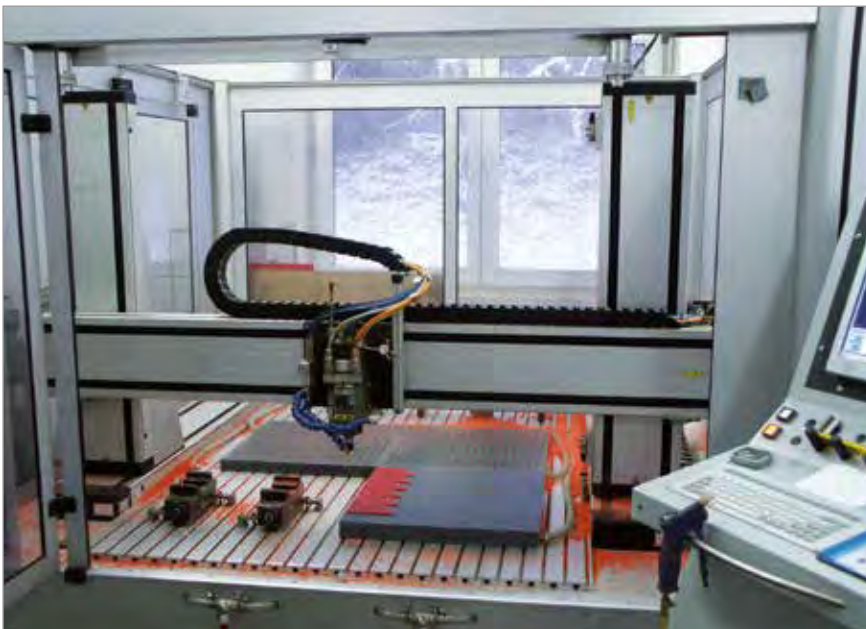

A CAD/CAM workstation

A direct extension from the principles of CAD

EuroDidact®

► Maltese Cross Tube S

Highly evacuated electron tube with divergent electron gun, fluorescent screen and Maltese cross. For demonstrating the straight line propagation of electrons in the absence of any electric or magnetic field by projecting the shadow of a Maltese cross onto the fluorescent screen and for introducing students to electron optics.

Please see page 238

